



GROWING TOGETHER

TECHNICAL DATABOOK 2024



AGRICULTURAL TIRES





GROWING TOGETHER

2024 Technical DataBook

AGRICULTURAL TIRES



Range



TRACTOR

Radial Bias



AGRIFORCE BK T71

Pag. 34



AGRIMAXFACTOR

Pag. 36



AGRIMAX V-FLECTO

Pag. 44



AGRIMAX RT 955

Pag. 138



AGRIMAX TURF RT 333

Pag. 144



RT 851

Pag. 150



AGRIMAX SPARGO

Pag. 56



AGRIMAX FORCE

Pag. 60



AGRIMAX SIRIO

Pag. 72



RT 853

Pag. 150



RT 857

Pag. 152



RIDEMAX IT 696

Pag. 156



AGRIMAX FORTIS

Pag. 74



AGRIMAX RT 657

Pag. 78



AGRIMAX RT 765

Pag. 88



RIDEMAX IT 697 (M+S)

Pag. 162



TRAC SUPER

Pag. 166



RT 747 AGRO INDUSTRIAL

Pag. 168



AGRIMAX RT 855

Pag. 108



AGRIMAX RT 945

Pag. 130



AGRIMAX ELOS

Pag. 134



TR 126

Pag. 170



TR 128

Pag. 172



TR 133

Pag. 174



Range



TRACTOR

Radial Bias



TR 135

Pag. 176



TR 136

Pag. 210



TR 144

Pag. 214



COMMANDER (R)

Pag. 252



TR 270

Pag. 256



TR 273

Pag. 262



TR 145

Pag. 218



TR 171

Pag. 220



TR 173

Pag. 232



PUDDLE SPECIAL (A)

Pag. 266



PUDDLE SPECIAL (B)

Pag. 266



TR 318

Pag. 268



FARM 2000

Pag. 234



FARM 2000 PLUS

Pag. 240



FARM SPECIAL

Pag. 242



AT 316

Pag. 270



AS 2001

Pag. 246



TRAC FARM

Pag. 248



TRAC FARM PLUS

Pag. 250





Range



HARVESTER

Radial Bias



AGRIMAX TERIS

Pag. 274



AGRIMAX RT 600

Pag. 280



RM 500

Pag. 286



AGRIMAX RI 818

Pag. 312



TR 117

Pag. 314



TR 118

Pag. 318



STAR TRAC

Pag. 288



HARVESTER SPECIAL

Pag. 288



COMMANDER (R)

Pag. 290



TR 137

Pag. 294



TR 360

Pag. 296



TR 882

Pag. 298



FLOTATION 558

Pag. 302



BK 308

Pag. 308

PIVOT IRRIGATOR

Radial Bias





Range



FLOTATION

Radial Bias



V-FLEXA
 Pag. 322



RIDEMAX FL 699
 Pag. 326



FL 634 PERFORMA
 Pag. 328



RIDEMAX FL 615
 Pag. 362



FLOTATION 351
 Pag. 364



FLOTATION 558
 Pag. 366



FL 633 PERFORMA
 Pag. 330



RIDEMAX FL 690
 Pag. 332



RIDEMAX FL 693 M
 Pag. 334



FLOTATION 647
 Pag. 372



FLOTATION 648
 Pag. 374



FLOTATION 648 T
 Pag. 402



FL 630 SUPER
 Pag. 344



FL 630 ULTRA
 Pag. 350



FL 635
 Pag. 354



FLOTATION TR 675
 Pag. 404



FLOTATION TR 678
 Pag. 408



FLOTATION RIB 774
 Pag. 410



FL 637
 Pag. 356



FL 639
 Pag. 358



FL 695
 Pag. 360



Range



FORESTRY

Radial Bias



FORESTECH

Pag. 414



FS 216

Pag. 416



F 240

Pag. 422



TR 675

Pag. 424



TR 678

Pag. 426



FORESTLAND

Pag. 428



FORESTMEX

Pag. 430



MULTIMAX MP 513

Pag. 434



MULTIMAX MP 515

Pag. 438



MULTIMAX MP 519

Pag. 438



MULTIMAX MP 522

Pag. 440



MULTIMAX MP 527

Pag. 446



MULTIMAX MP 529

Pag. 450



MULTIMAX MP 540

Pag. 452



MULTIMAX MT 518

Pag. 454



MULTIMAX MT 538

Pag. 456



CON STAR

Pag. 458



AS 504

Pag. 462



AT 603

Pag. 494

MULTIUSE

Radial Bias





Range



MULTIUSE

Bias



AT 621

Pag. 498



MP 567

Pag. 506



MP 570

Pag. 516



MP 585

Pag. 518



MP 590

Pag. 518



MP 600

Pag. 520



TR 459

Pag. 522



TR 461

Pag. 528



TR 463

Pag. 530



TF 8181

Pag. 534



TF 9090

Pag. 542



TF 9393

Pag. 548



COMMANDER (F)

Pag. 550



COMMANDER TWIN RIB

Pag. 552



COMMANDER 3 RIB

Pag. 554



POWER RIB F2

Pag. 554



PRO RIB F2M

Pag. 556



RIB F3

Pag. 558



STEER FARM

Pag. 560

Bias



FRONT



Range



IMPLEMENT

Radial Bias



AW 711

Pag. 564



AW 712

Pag. 568



AS 511

Pag. 568



AW - 18

Pag. 618



BK 4040

Pag. 620



RIB IMPLEMENT (A)

Pag. 622



RM 500

Pag. 570



AW 702

Pag. 572



AW 705

Pag. 586



RIB IMPLEMENT (B)

Pag. 622



RIB 713

Pag. 624



RIB 774 (A)

Pag. 626



AW 708

Pag. 592



AW 726

Pag. 598



AW 729

Pag. 602



RIB 774 (B)

Pag. 630



RIB 774 (C)

Pag. 632



RIB 775

Pag. 634



TERRA TRAX

Pag. 606



AW 909

Pag. 608



AW 09

Pag. 612



RIB 900

Pag. 634



RIB MASTER

Pag. 636



FLOTATION RIB IMPLEMENT

Pag. 636



Range



IMPLEMENT

Radial Bias



MULTI RIB

Pag. 638



AS 504

Pag. 640



AS 505

Pag. 672



AS 507

Pag. 674



AS 509

Pag. 676



FARM 2000

Pag. 678



TR 393

Pag. 686



TR 393 (B)

Pag. 688



TR 882

Pag. 690



SL 441

Pag. 694



PL 846

Pag. 696



SR 713

Pag. 698



TR 360

Pag. 702



LG SMOOTH

Pag. 702



LG 306

Pag. 704



LG 307

Pag. 714



LG 408

Pag. 716



LG RIB

Pag. 718



LG RIB PLUS

Pag. 720



AGRIMAX TURF RT 333

Pag. 722



TRAC MASTER

Pag. 728



TR 313

Pag. 730



TR 315

Pag. 732



AT 316

Pag. 736

LAWN & GARDEN

Radial Bias





Range



LAWN & GARDEN

Radial Bias



TR 317

Bias Pag. 736



TR 318

Bias Pag. 738



TR 319

Bias Pag. 738



GOLF

Bias



GF 304

Bias Pag. 742



GF 305 CLASSIC

Bias Pag. 742



POWERTRAILER SR 331

Bias Pag. 746



GF 305 FARM TRAILER

Bias Pag. 748



INDUSTRIAL RIB F3

Bias Pag. 750



I - 1

Bias Pag. 752



AGRI GRIP

Bias Pag. 764



FARM HIGHWAY TOUGH

Bias Pag. 766



BK 208

Bias Pag. 768



BK 308

Bias Pag. 768



BK 627

Bias Pag. 770



BK 823

Bias Pag. 770



BK 826

Bias Pag. 772



BK RUF N TUF

Bias Pag. 776



Range



TRAILER

Radial Bias



SL 441
 Pag. 778



ST 180
 Pag. 780



TR 387
 Pag. 786



FLOTATION V LINE
 Pag. 812



MT 612
 Pag. 814



RM 2002
 Pag. 816



TR 390
 Pag. 790



TR 391
 Pag. 792



AGRI TRAILER
 Pag. 792



TUF LUG
 Pag. 818



VIJETA
 Pag. 820



RIB TRAILER
 Pag. 794



ARROW
 Pag. 796



COLT
 Pag. 800



D 404
 Pag. 802



D 405
 Pag. 808



DON 2000
 Pag. 810



Range



TRANSPORT

Bias



MH TR 182

Pag. 824



LT TR 182

Pag. 826

ATV

Radial Bias



W 207

Pag. 830



AT 108

Pag. 836



AT 109

Pag. 842



AT 110

Pag. 844



AT 111

Pag. 846



AT 111 HD

Pag. 850



AT 112

Pag. 852



AT 119

Pag. 854



AT 171

Pag. 856



BOGMAX

Pag. 862



SIERRA MAX

Pag. 864



SIERRA MAX PRO

Pag. 866



Range



GO KART

 Bias



SM 48 (GK)

 Pag. 870



SM 54 (GK)

 Pag. 870



SM 68 (GK)

 Pag. 872





Legend of icons

TECHNOLOGIES

 All Steel Radial	 All Steel	 Aramid Belted	 Block Pattern	 Deep Tread
 Extra Deep Tread	 eReady	 Extra Steel Belted	 Hard Compound	 Heavy Duty
 Hard Rocky Surface	 High Speed	 IF Technology	 Larger Footprint	 More Belts
 More Lugs	 M+S	 Narrow Rim Option	 Reinforced Bead	 Reinforced Carcass
 Reinforced Shoulder	 Rounded Shoulder Technology	 Smooth Tire	 Snow Pattern	 Special Antistatic Compound
 Special Compound	 Steel Belted	 Strong Casing	 VF Technology	 Directional Tread Pattern

PERFORMANCE

 Comfort	 Cut and Chip Resistance	 Cut Resistance	 Durability	 Excellent flotation
 Field Protection	 For muddy ground	 Fuel Economy	 Handling and Comfort	 Hard Surfaces
 Heat Resistance	 High Load Capacity	 High Mileage	 High Puncture Resistance	 Ice and Snow
 Ideal for grassland	 Low Rolling Resistance	 Multi-Purpose Tires	 On/Off Road	 Reduced Soil Compaction
 Road Oriented	 Self-Cleaning	 Sport	 Stability	 Steering Control
 Stubble Resistance	 Traction	 Traction on Sand		



How to read technical data

Tire size

This data indicates tire size according to international standards.

The Version parameter indicates whether the tyre is a standard version or has specific characteristics for a different use.

Version



RIM Rec. parameter indicates the recommended rim size for the tire according to ETRTO.

RIM Alt. parameter indicates the alternative rim size for the tire according to technical standard.

PR

The PR parameter states for "Ply Rating" and is an expression of the tire's load capacity, primarily used for conventional tires.

Type

This parameters indicates whether the tire is tubeless (TL) or the type of air chamber mounted.

SRI

The Speed Radius Index parameter is a theoretical value used to calculate the speed of a vehicle according to EU homologation procedures, and for a potential interchangeability of tire dimension.

LOAD INDEX / SPEED SYMBOL

The load index is a numeric code that defines the tire's maximum loading capacity in kg. For each tire type/size, the loading capacity is always related to a specific inflation pressure as defined by ETRTO standards and manufacturer specifications.

Speed Symbol: the speed code is a symbol that indicates the maximum speed admitted at the given load index, following any other specific conditions defined by the tire manufacturer.

This parameter indicates the "Load Index" and the "Speed Code" for tire fitted on a drive wheel.

This parameter indicates the "Load Index" and the "Speed Code" for tire fitted on a free rolling wheel.

LI/SS Drive Wheel

LI/SS Free Rolling

RIM Rec./Alt.



S.W.

SECTION WIDTH

This parameter indicates the outer sidewall distance without taking into consideration the prominences due to tire code marking. The section width is measured after the tire being properly mounted on the reference rim and inflated at the pressure recommended by the manufacturer for at least 24 hours without any load.

OVERALL DIAMETER

This parameter is measured after the tire being properly mounted on the reference rim and inflated at the pressure recommended by the manufacturer for at least 24 hours without any load.

SLR - STATIC LOADED RADIUS

This parameter indicates the vertical distance between the ground and the tire rotation axis. It is measured with the tire inflated at its nominal pressure, properly mounted on its reference rim at maximum load according to the values defined in the load index.

ROLLING CIRCUMFERENCE

indicates the distance the tire travels in one revolution



O.D.



SLR



RC



TRACTOR



Radial



AGRIMAX V-FLECTO (R-1W)

AGRIMAX V-FLECTO is BKT's response to the challenging demand of both technology and performance for high-power tractors. This tire is perfect for soil tillage and haulage applications thanks to reduced soil compaction and self-cleaning properties. With the exclusive VF technology, AGRIMAX V-FLECTO can carry heavy loads with a lower inflating pressure compared to standard and IF tires, reaching high speeds. It also features the Narrow Rim Option that allows mounting standard rims on the tire. BKT has designed this tire with optimized geometry to enhance driving comfort both in the fields and on the road reducing fuel consumption.

Ø 28"	Tire size	LI/SS	RIM		S.W. (mm)	O.D. (mm)	SLR (mm)	RC (mm)	SRI (index)	Version
			Rec.	Alt.						
	VF 480/60 R 28 NRO	145 D	DW 16 L	W 16 L	470	1290	571	3807	625	STD
	VF 520/60 R 28 NRO	149 D	DW 18 L	W 18 L	516	1335	587	3910	650	STD
	VF 540/65 R 28 NRO	154 D	DW 20 B	DW 18 L	549	1413	622	4160	675	STD
	VF 600/60 R 28 NRO	157 D	DW 20 B	DW 18 L	587	1440	632	4228	675	STD
	VF 600/65 R 28 NRO	163 D	DW 21 B	DW 20 B	597	1491	655	4453	700	STD
Ø 30"	VF 540/65 R 30 NRO	158 D	DW 20 B	DW 18 L	549	1464	650	4351	700	STD

STD: Standard





TRACTOR







TRACTOR



AGRIFORCE BK T71

AGRIFORCE BK T71 is BKT's brand-new rubber track series for high-power tractors employed in general tillage and row crop applications. The tread is made of a high-performance compound that ensures maximum resistance against cuts, tears, and abrasion. The optimized tread pattern provides excellent traction and ride comfort, whereas the drive lugs of the positive drive system have an optimized shape for best flexibility. In addition, the track carcass has been reinforced with four layers of high-tensile steel cords. As a result, AGRIFORCE BK T71 offers the perfect balance of high dimensional stability and flexibility to ensure extraordinary durability in all seasons. Farming tracks have no metal core, a feature that improves flexibility especially on wet and soft soil. The overall advantages of rubber tracks are enhanced productivity and performance since track-driven tractors can run at higher speeds on field at the same power and show improved fuel efficiency.

AGRIFORCE

WIDTH	BRAND/ EQUIPMENT	TRACK SIZE	TRACK WIDTH in (mm)	TRACK LENGTH mm	TREAD LUGS			GUIDE LUGS	DRIVE LUGS	CARCASS			Load capacity (lbs/tire)	
					Qty No's	Height mm	Pitch in (mm)	Qty No's	Qty No's	Plies mm	Main cable size mm	Thickness mm	mph / psi	-
18" 	Case IH Steiger Rowtrac; New Holland Smart Trax	18" x 6" x 44	18 (457)	6705.6	88	51	6 (152.4)	-	44	3	5.2	35	-	-
	-	18" x 6" x 53	18 (457)	8077.2	106	51	6 (152.4)	-	53	3	5.2	35	-	-
	-	18" x 6" x 54	18 (457)	8229.6	108	51	6 (152.4)	-	54	3	5.2	35	-	-
	-	18" x 6" x 58	18 (457)	8839.2	116	51	6 (152.4)	-	58	3	5.2	35	-	-
	-	18" x 6" x 59	18 (457)	8991.6	118	51	6 (152.4)	-	59	3	5.2	35	-	-
34" 	-	34" x 6" x 44	34 (864)	6705.6	88	51	6 (152.4)	-	44	3	5.2	37	-	-

Technologies



Reinforced Carcass

Performance



Traction



Cut Resistance



Self-Cleaning



Comfort



Durability





AGRIMAXFACTOR

AGRIMAXFACTOR is BKT's brand-new 70 series for tractors that is perfect for both haulage and soil tillage operations. The improved tread design with further increased lug length and changed lug orientation stands for better roadability. The reduced lug angle ensures less rolling resistance, whilst the by 5% increased contact area on the land significantly reduced the noise perception in the cabin - both features stand for more comfort. In addition, the strong polyester casing provides extraordinary lateral stability and a faster steering response even for high-speed operations or heavy-duty service. The tire's braking results on wet surface are excellent. In a nutshell, AGRIMAXFACTOR's overall advantages are great handling in combination with under many aspects extraordinary driving comfort in addition to excellent durability - all particular requirements by increasingly heavier machinery including the higher weight of e-vehicles' battery packages. The exclusive sidewall shows the perfectly aligned "E-READY" logo that highlights BKT's commitment to electric mobility.

AGRIMAXFACTOR

Ø 24"	Tire size	LI/SS	RIM		S.W. (mm)	O.D. (mm)	SLR (mm)	RC (mm)	SRI (index)	Version	Load capacity (kg/tire)						
			Rec.	Alt.							km/h - bar						
											0.6	0.8	1.0	1.2	1.4	1.6	
380/70 R 24	125 D / 128 A8	W 12	W 11 ; W 13	380	1190	538	3524	575	STD	65	910	1060	1205	1355	1505	1650	
										50	955	1115	1270	1425	1580	1735	
										40	1000	1160	1325	1485	1650	1810	
										30	1045	1220	1390	1560	1730	1900	
										10 LT	1220	1420	1620	1820	2020	2215	
										10 HT	1045	1220	1390	1560	1730	1900	
										UPCOMING SIZE							
420/70 R 24	134 D / 137 A8	W 13	W 12 ; W 14 L	418	1248	563	3696	600	STD	65	1060	1230	1400	1590	1760	1930	2120
										50	1115	1295	1475	1675	1855	2030	2230
										40	1165	1350	1535	1745	1930	2120	2325
										30	1220	1420	1615	1830	2030	2225	2440
										10 LT	1425	1655	1880	2135	2365	2590	2745
										10 HT	1220	1420	1615	1830	2030	2225	2440
										UPCOMING SIZE							

Ø 28"	Tire size	LI/SS	RIM		S.W. (mm)	O.D. (mm)	SLR (mm)	RC (mm)	SRI (index)	Version	Load capacity (kg/tire)						
			Rec.	Alt.							km/h - bar						
											0.6	0.8	1.0	1.2	1.4	1.6	
380/70 R 28	127 D / 130 A8	W 12	W 11 ; W 13	380	1293	588	3836	625	STD	65	965	1120	1280	1435	1595	1750	
										50	1015	1180	1345	1510	1675	1840	
										40	1060	1230	1405	1575	1750	1920	
										30	1110	1290	1475	1655	1835	2015	
										10 LT	1290	1505	1715	1925	2135	2345	
										10 HT	1110	1290	1475	1655	1835	2015	
										420/70 R 28	133 D / 136 A8	W 13	W 12 ; W 14 L	418	1349	606	4000
50	1195	1390	1585	1780	1975	2165											
40	1245	1450	1650	1855	2060	2260											
30	1305	1520	1735	1945	2160	2370											
10 LT	1525	1770	2020	2270	2520	2765											
10 HT	1305	1520	1735	1945	2160	2370											

STD: Standard

Technologies



Performance





AGRIMAXFACTOR

Ø 28"	Tire size	LI/SS	RIM		S.W. (mm)	O.D. (mm)	SLR (mm)	RC (mm)	SRI (index)	Version	Load capacity (kg/tire)									
			Rec.	Alt.							km/h - bar	0.6	0.8	1.0	1.2	1.4	1.6			
480/70 R 28	140 D/143 A8	W 15 L	W 14 L ; W 16 L	479	1421	639	4239	675	STD	65	1375	1600	1825	2050	2275	2500				
										50	1445	1680	1920	2155	2390	2625				
										40	1510	1755	2005	2250	2495	2740				
										30	1585	1840	2100	2360	2620	2875				
										10 LT	1845	2145	2450	2750	3050	3350				
										10 HT	1585	1840	2100	2360	2620	2875				
										65	1940	2230	2560	2890	3220	3550	3880	4125		
										50	2040	2345	2690	3035	3385	3730	4075	4335		
										40	2125	2445	2805	3165	3530	3890	4250	4520		
										30	2235	2565	2945	3325	3705	4085	4465	4745		
10 LT	2600	2990	3430	3875	4315	4760	5200	5530												
10 HT	2235	2565	2945	3325	3705	4085	4465	4745												
600/70 R 28	157 D/160 A8	DW 20 B	DW 18 L ; W 18 L	611	1551	714	4667	725	STD	65	1420	1650	1880	2115	2345	2575				
										50	1490	1735	1975	2220	2465	2705				
										40	1555	1805	2060	2315	2570	2800				
										30	1635	1900	2165	2435	2700	2965				
										10 LT	1905	2215	2525	2835	3145	3455				
										10 HT	1635	1900	2165	2435	2700	2965				
										65	1955	2275	2595	2915	3235	3550				
										50	2055	2390	2725	3060	3395	3730				
										40	2135	2480	2830	3180	3530	3875				
										30	2250	2615	2985	3350	3720	4085				
10 LT	2620	3050	3475	3905	4335	4760														
10 HT	2250	2615	2985	3350	3720	4085														
Ø 30"	480/70 R 30	W 15 L	W 14 L ; W 16 L	479	1478	670	4391	700	STD	65	1530	1755	2015	2275	2535	2795	3055	3250		
										50	1610	1845	2120	2395	2665	2940	3215	3415		
										40	1675	1925	2210	2495	2780	3065	3350	3560		
										30	1760	2020	2320	2620	2920	3220	3520	3740		
										10 LT	2050	2355	2705	3050	3400	3750	4095	4355		
										10 HT	1760	2020	2320	2620	2920	3220	3520	3740		
										65	1515	1785	2055	2290	2560	2790	3065	3295	3605	3875
										50	1590	1875	2160	2405	2690	2935	3220	3460	3790	4070
										40	1660	1955	2250	2505	2805	3060	3355	3610	3950	4245
										30	1740	2055	2365	2635	2945	3215	3525	3795	4150	4460
10 LT	2030	2390	2755	3070	3430	3745	4105	4420	4835	5195										
10 HT	1740	2055	2365	2635	2945	3215	3525	3795	4150	4460										
Ø 34"	480/70 R 34	W 15 L	W 14 L ; W 16 L	479	1580	729	4761	750	STD	65	1530	1755	2015	2275	2535	2795	3055	3250		
										50	1610	1845	2120	2395	2665	2940	3215	3415		
										40	1675	1925	2210	2495	2780	3065	3350	3560		
										30	1760	2020	2320	2620	2920	3220	3520	3740		
										10 LT	2050	2355	2705	3050	3400	3750	4095	4355		
										10 HT	1760	2020	2320	2620	2920	3220	3520	3740		
										65	1515	1785	2055	2290	2560	2790	3065	3295	3605	3875
										50	1590	1875	2160	2405	2690	2935	3220	3460	3790	4070
										40	1660	1955	2250	2505	2805	3060	3355	3610	3950	4245
										30	1740	2055	2365	2635	2945	3215	3525	3795	4150	4460
10 LT	2030	2390	2755	3070	3430	3745	4105	4420	4835	5195										
10 HT	1740	2055	2365	2635	2945	3215	3525	3795	4150	4460										
Ø 38"	480/70 R 38	W 15 L	W 14 L ; W 16 L	479	1681	758	5000	800	STD	65	1595	1860	2120	2380	2640	2900				
										50	1675	1950	2225	2500	2775	3045				
										40	1750	2040	2325	2610	2895	3180				
										30	1835	2135	2435	2735	3035	3335				
										10 LT	2140	2490	2840	3190	3540	3890				
										10 HT	1935	2135	2435	2735	3035	3335				

Technologies



EcoReady



High Speed



Heavy Duty

Performance



Durability



Stability



Steering Control



Handling and Comfort

STD: Standard





AGRIMAXFACTOR

Ø 38"	Tire size	LI/SS	RIM		S.W. (mm)	O.D. (mm)	SLR (mm)	RC (mm)	SRI (index)	Version	Load capacity (kg/tire)									
			Rec.	Alt.							km/h - bar	0.6	0.8	1.0	1.2	1.4	1.6			
520/70 R 38	150 D/ 153 A8	W 16 L	W 15 L; W 18 L	516	1749	795	5239	825	STD	65	1845	2145	2450	2750	3050	3350				
										50	1940	2255	2570	2890	3205	3520				
										40	2020	2350	2680	3010	3340	3670				
										30	2125	2470	2815	3165	3510	3855				
										10 LT	2470	2875	3280	3685	4090	4490				
										10 HT	2125	2470	2815	3165	3510	3855				
580/70 R 38	155 D/ 158 A8	W 18 L	DW18L; DD18L	577	1827	823	5456	875	STD	65	2135	2480	2830	3180	3530	3875				
										50	2240	2605	2975	3340	3705	4070				
										40	2335	2720	3100	3485	3865	4245				
										30	2455	2855	3260	3660	4060	4460				
										10 LT	2860	3325	3795	4260	4730	5195				
										10 HT	2455	2855	3260	3660	4060	4460				
710/70 R 38	166 D/ 169 A8	DW 23 B	-	716	1959	866	5800	925	STD	65	2915	3395	3870	4350	4825	5300				
										50	3065	3565	4065	4565	5065	5565				
										40	3195	3720	4240	4765	5285	5805				
										30	3355	3905	4450	5000	5550	6095				
										10 LT	3910	4550	5190	5830	6470	7105				
										10 HT	3355	3905	4450	5000	5550	6095				
710/70 R 38	171 D/ 174 A8	DW 23 B	DW 25 B	716	1959	866	5800	925	STD	65	2895	3325	3815	4305	4800	5290	5785	6150		
										50	3040	3490	4010	4525	5040	5560	6075	6460		
										40	3150	3620	4155	4690	5230	5765	6300	6700		
										30	3330	3825	4390	4955	5520	6085	6655	7075		
										10 LT	3880	4455	5115	5775	6435	7095	7755	8245		
										10 HT	3330	3825	4390	4955	5520	6085	6655	7075		
710/70 R 38	175 D/ 178 A8	DW 23 B	-	716	1959	866	5800	925	STD	65	2695	3175	3660	4075	4555	4970	5455	5865	6420	6900
										50	2830	3335	3840	4275	4785	5220	5725	6160	6740	7245
										40	2925	3450	3975	4425	4950	5400	5925	6375	6975	7500
										30	3095	3655	4210	4685	5240	5715	6270	6745	7380	7935
										10 LT	3610	4255	4905	5460	6105	6660	7310	7865	8605	9250
										10 HT	3095	3655	4210	4685	5240	5715	6270	6745	7380	7935
Ø 42"	620/70 R 42	160 D/ 163 A8	DW 20 B	DW18L; W18L	625	1935	863	5786	925	STD	65	2475	2880	3285	3690	4095	4500			
											50	2600	3025	3450	3875	4300	4725			
											40	2715	3160	3600	4045	4490	4930			
											30	2850	3315	3780	4245	4710	5175			
											10 LT	3320	3860	4405	4945	5490	6030			
											10 HT	2850	3315	3780	4245	4710	5175			

STD: Standard

Technologies



EcoReady



High Speed



Heavy Duty

Performance



Durability



Stability



Steering Control



Handling and Comfort





AGRIMAXFACTOR

Ø 42"	Tire size	LI/SS	RIM		S.W. (mm)	O.D. (mm)	SLR (mm)	RC (mm)	SRI (index)	Version	Load capacity (kg/tire)									
			Rec.	Alt.							km/h - bar	0.6	0.8	1.0	1.2	1.4	1.6	2.0	2.4	
620/70 R 42	166 D/ 169 A8	DW 20 B	DW18L; W18L	625	1935	876	5801	925	STD	65	2495	2865	3290	3710	4135	4560	4985	5300		
										50	2620	3010	3455	3900	4345	4790	5235	5565		
										40	2730	3135	3600	4065	4530	4995	5460	5800		
										30	2865	3295	3780	4270	4755	5245	5730	6095		
										10 LT	3340	3840	4410	4975	5545	6115	6680	7105		
										10 HT	2865	3295	3780	4270	4755	5245	5730	6095		
620/70 R 42	173D/ 176A8	DW 20 B	DW18L; W18L	625	1935	876	5804	925	STD	km/h - bar	0.6	0.8	1.0	1.2	1.4	1.6	2.0	2.4	2.8	3.2
										65	2535	2990	3445	3835	4290	4680	5135	5525	6045	6500
										50	2665	3140	3620	4030	4505	4915	5395	5805	6350	6825
										40	2780	3280	3775	4205	4700	5130	5625	6055	6625	7120
										30	2920	3440	3965	4415	4935	5385	5910	6355	6955	7475
										10 LT	3400	4010	4620	5140	5750	6275	6885	7405	8105	8710
10 HT	2920	3440	3965	4415	4935	5385	5910	6355	6955	7475										
710/70 R 42	173 D/ 176 A8	DW 23 B	DW 25 B	716	2061	935	6198	975	STD	km/h - bar	0.6	0.8	1.0	1.2	1.4	1.6	2.0	2.4		
										65	3055	3510	4030	4550	5070	5590	6110	6500		
										50	3210	3690	4235	4780	5325	5870	6420	6825		
										40	3340	3835	4405	4970	5540	6110	6675	7100		
										30	3515	4040	4635	5235	5835	6430	7030	7475		
										10 LT	4095	4705	5405	6100	6795	7495	8190	8710		
10 HT	3515	4040	4635	5235	5835	6430	7030	7475												
710/70 R 42	176 D/ 179 A8	DW 23 B	DW 25 B	716	2061	-	-	975	STD	km/h - bar	0.6	0.8	1.0	1.2	1.4	1.6	2.0	2.4	2.8	
										65	3055	3550	4050	4545	5045	5540	6110	6465	7100	
										50	3210	3730	4250	4775	5295	5815	6415	6785	7455	
										40	3335	3875	4420	4960	5505	6045	6665	7055	7750	
										30	3515	4085	4655	5230	5800	6370	7025	7435	8165	
										10 LT	4095	4760	5425	6090	6760	7425	8185	8660	9515	
10 HT	3515	4085	4655	5230	5800	6370	7025	7435	8165											

STD: Standard

Technologies



ready



High Speed



Heavy Duty

Performance



Durability



Stability



Steering Control



Handling and Comfort



TRACTOR

Radial



AGRIMAX V-FLECTO (R-1W)

AGRIMAX V-FLECTO is BKT's response to the challenging demand of both technology and performance for high-power tractors. This tire is perfect for soil tillage and haulage applications thanks to reduced soil compaction and self-cleaning properties. With the exclusive VF technology, AGRIMAX V-FLECTO can carry heavy loads with a lower inflating pressure compared to standard and IF tires, reaching high speeds. It also features the Narrow Rim Option that allows mounting standard rims on the tire. BKT has designed this tire with optimized geometry to enhance driving comfort both in the fields and on the road reducing fuel consumption.

AGRIMAX V-FLECTO
RADIAL VF TECHNOLOGY TIRES

Ø 28"	Tire size	LI/SS	RIM		S.W. (mm)	O.D. (mm)	SLR (mm)	RC (mm)	SRI (index)	Version	Load capacity (kg/tire)						
			Rec.	Alt.							km/h - bar						
											0.6	0.8	1.0	1.2	1.4	1.6	
VF 480/60 R 28 NRO	145 D	DW 16 L W 16 L	470	1290	571	3807	625	STD	70	1450	1685	1920	2160	2395	2635		
									from 65 to 40	1595	1855	2115	2375	2635	2900		
									30	1625	1890	2155	2420	2685	2955		
									20	1655	1925	2195	2470	2740	3015		
									10	1750	2040	2325	2610	2895	3190		
									up to 10 Cyc with front loader*	2230	2595	2960	3325	3685	4060		
									10HT	1625	1890	2155	2420	2685	2955		
									70	1620	1890	2155	2425	2685	2955		
from 65 to 40	1785	2080	2370	2665	2955	3250											
30	1820	2120	2415	2715	3010	3315											
20	1855	2160	2460	2770	3070	3380											
10	1960	2285	2605	2930	3250	3575											
up to 10 Cyc with front loader*	2495	2910	3315	3730	4135	4550											
10 HT	1820	2120	2415	2715	3010	3315											
VF 520/60 R 28 NRO	149 D	DW 18 L W 18 L	516	1335	587	3910	650	STD	70	1910	2250	2555	2865	3135	3410		
									from 65 to 40	2100	2475	2810	3150	3450	3750		
									30	2140	2520	2865	3210	3515	3825		
									20	2180	2570	2920	3275	3585	3900		
									10	2310	2720	3090	3465	3795	4125		
									up to 10 Cyc with front loader*	2940	3465	3930	4410	4830	5250		
									10 HT	2140	2520	2865	3210	3515	3825		
									70	2060	2400	2735	3075	3410	3750		
from 65 to 40	2265	2640	3010	3380	3750	4125											
30	2310	2690	3070	3445	3825	4205											
20	2355	2745	3130	3515	3900	4290											
10	2490	2900	3310	3715	4125	4535											
up to 10 Cyc with front loader*	3170	3695	4210	4730	5250	5775											
10 HT	2310	2690	3070	3445	3825	4205											
VF 540/65 R 28 NRO	154 D	DW 20 B DW 18 L	549	1413	622	4160	675	STD	70	2265	2620	2975	3375	3690	4000	4440	
									From 65 to 40	2490	2880	3270	3705	4050	4390	4875	
									30	2540	2940	3335	3785	4130	4480	4975	
									20	2590	2995	3400	3855	4210	4565	5070	
									10	2740	3170	3595	4080	4455	4830	5365	
									up to 10 Cyc with front loader*	3485	4030	4575	5190	5665	6145	6825	
									10 HT	2540	2940	3335	3785	4130	4480	4975	
									70	2425	2820	3270	3665	4060	4455	4955	
From 65 to 40	2670	3105	3595	4030	4465	4905	5450										
30	2720	3165	3665	4110	4555	4995	5555										
20	2775	3225	3735	4190	4645	5095	5665										
10	2935	3415	3955	4435	4915	5395	5995										
up to 10 Cyc with front loader*	3735	4345	5035	5645	6255	6865	7630										
10 HT	2720	3165	3665	4110	4555	4995	5555										
VF600/70 R 28	167 D	DW 21 B DW 20 B	603	1551	662	4572	725	STD	70	2265	2620	2975	3375	3690	4000	4440	
									From 65 to 40	2490	2880	3270	3705	4050	4390	4875	
									30	2540	2940	3335	3785	4130	4480	4975	
									20	2590	2995	3400	3855	4210	4565	5070	
									10	2740	3170	3595	4080	4455	4830	5365	
									up to 10 Cyc with front loader*	3485	4030	4575	5190	5665	6145	6825	
									10 HT	2540	2940	3335	3785	4130	4480	4975	
									70	2425	2820	3270	3665	4060	4455	4955	
From 65 to 40	2670	3105	3595	4030	4465	4905	5450										
30	2720	3165	3665	4110	4555	4995	5555										
20	2775	3225	3735	4190	4645	5095	5665										
10	2935	3415	3955	4435	4915	5395	5995										
up to 10 Cyc with front loader*	3735	4345	5035	5645	6255	6865	7630										
10 HT	2720	3165	3665	4110	4555	4995	5555										

STD: Standard

*For up to 10 Cyc with front loader application inflation pressure to be increased by 0.8 bar.

Technologies



High Speed



Reinforced Bead



VF Technology



Narrow Rim Option

Performance



Fuel Economy



Handling and Comfort



High Load Capacity



Reduced Soil Compaction



Self-Cleaning



Traction





TRACTOR

AGRIMAX V-FLECTO (R-1W)

Ø 30"	Tire size	LI/SS	RIM		S.W. (mm)	O.D. (mm)	SLR (mm)	RC (mm)	SRI (index)	Version	Load capacity (kg/tire)							
			Rec.	Alt.							km/h - bar	0.6	0.8	1.0	1.2	1.4	1.6	2.0
Ø 30"	VF 540/65 R 30 NRO	158 D	DW 20 B	DW 18 L	549	1464	650	4351	700	STD	70	1970	2275	2585	2935	3205	3480	3865
											from 65 to 40	2165	2505	2845	3230	3525	3825	4250
											30	2205	2555	2900	3290	3595	3900	4335
											20	2250	2605	2955	3355	3665	3975	4420
											10	2380	2755	3125	3550	3875	4205	4675
											up to 10 Cyc with front loader*	3030	3505	3980	4520	4935	5355	5950
	10 HT	2205	2555	2900	3290	3595	3900	4335										
	70	2120	2475	2820	3170	3515	3865	4250										
	from 65 to 40	2335	2720	3100	3485	3865	4250	4675										
	30	2380	2770	3160	3550	3940	4335	4750										
	20	2425	2825	3220	3620	4015	4420	4840										
	10	2565	2990	3410	3830	4250	4675	5100										
	up to 10 Cyc with front loader*	3270	3805	4340	4875	5410	5950	6485										
	10 HT	2380	2770	3160	3550	3940	4335	4750										
	70	2545	2950	3360	3820	4225	4635	5095										
	From 65 to 40	2800	3245	3695	4200	4645	5095	5600										
	30	2855	3305	3765	4280	4735	5195	5710										
	20	2910	3370	3840	4365	4830	5295	5820										
10	3080	3565	4060	4620	5105	5600	6160											
up to 10 Cyc with front loader*	3920	4540	5170	5880	6500	7130	7840											
10 HT	2855	3305	3765	4280	4735	5195	5710											
Ø 34"	VF 600/60 R 34	160 D	DW 20 B	DW 18 L ; DW 21 B	595	1584	691	4710	750	STD	70	2250	2620	2985	3355	3725	4095	4500
											From 65 to 40	2475	2880	3285	3690	4095	4500	4950
											30	2520	2935	3350	3760	4175	4590	5040
											20	2570	2995	3415	3835	4255	4680	5130
											10	2720	3165	3610	4055	4500	4950	5400
											up to 10 Cyc with front loader*	3465	4030	4595	5165	5730	6300	6870
	10 HT	2520	2935	3350	3760	4175	4590	5040										
	70	2730	3165	3600	4095	4530	4965	5460										
	From 65 to 40	3000	3480	3960	4500	4980	5460	6000										
	30	3060	3545	4035	4590	5075	5565	6120										
	20	3120	3615	4115	4680	5175	5675	6240										
	10	3300	3825	4355	4950	5475	6005	6600										
	up to 10 Cyc with front loader*	4200	4870	5540	6300	6970	7640	8400										
	10 HT	3060	3545	4035	4590	5075	5565	6120										
	70	2430	2800	3220	3590	4010	4380	4910	5275									
	From 65 to 40	2670	3075	3540	3945	4410	4815	5395	5800									
	30	2725	3135	3610	4025	4500	4910	5505	5915									
	20	2775	3200	3680	4105	4585	5005	5610	6030									
10	2935	3385	3895	4340	4850	5300	5935	6380										
up to 10 Cyc with front loader*	3740	4305	4955	5525	6175	6740	7555	8120										
10 HT	2725	3135	3610	4025	4500	4910	5505	5915										
70	2605	3010	3420	3880	4235	4590	5100	5600										
From 65 to 40	2860	3305	3755	4260	4650	5040	5600	6120										
30	2915	3375	3830	4345	4745	5145	5715	6240										
20	2975	3375	3830	4345	4745	5145	5715	6240										
10	3145	3635	4130	4685	5115	5545	6160	6740										
up to 10 Cyc with front loader*	4000	4630	5255	5960	6510	7060	7840	8400										
10 HT	2915	3375	3830	4345	4745	5145	5715	6240										
70	2780	3220	3655	4145	4530	5075	5460	6000										
From 65 to 40	3060	3540	4020	4560	4980	5580	6000	6600										
30	3120	3610	4100	4650	5075	5690	6120	6740										
20	3180	3680	4180	4740	5175	5800	6240	6800										
10	3365	3890	4420	5015	5475	6135	6600	7200										
up to 10 Cyc with front loader*	4280	4955	5625	6380	6970	7810	8400	9000										
10 HT	3120	3610	4100	4650	5075	5690	6120	6740										

*For up to 10 Cyc with front loader application inflation pressure to be increased by 0.8 bar.

Technologies



High Speed



Reinforced Bead



VF Technology



Narrow Rim Option

Performance



Fuel Economy



Handling and Comfort



High Load Capacity



Reduced Soil Compaction



Self-Cleaning



Traction





AGRIMAX V-FLECTO (R-1W)

Ø 34"	Tire size	LI/SS	RIM		S.W. (mm)	O.D. (mm)	SLR (mm)	RC (mm)	SRI (index)	Version	Load capacity (kg/tire)							
			Rec. 	Alt. 							km/h - bar	0.6	0.8	1.0	1.2	1.4	1.6	2.0
VF 710/60 R 34 NRO	173 D	DW 25 B	DW 24 B ; DW 27 B	708	1716	752	5097	825	STD	km/h - bar	0.6	0.8	1.0	1.2	1.4	1.6	2.0	
										70	3020	3490	3965	4500	4910	5325	5915	
										from 65 to 40	3315	3835	4355	4940	5395	5850	6500	
										30	3385	3915	4445	5040	5505	5970	6630	
										20	3450	3990	4530	5140	5615	6085	6760	
										10	3650	4220	4795	5435	5935	6435	7150	
										up to 10 Cyc with front loader*	4645	5370	6100	6920	7555	8190	9100	
										10 HT	3385	3915	4445	5040	5505	5970	6630	
VF 480/80 R 38	166 D	DW 16 L	DW 15 L	479	1733	774	5169	825	STD	km/h - bar	0.6	0.8	1.0	1.2	1.4	1.6	2.0	2.4
										70	2270	2605	2990	3375	3760	4150	4535	4820
										From 65 to 40	2495	2865	3290	3710	4135	4560	4985	5300
										30	2545	2920	3355	3785	4220	4650	5085	5405
										20	2590	2980	3420	3860	4300	4740	5180	5510
										10	2745	3150	3615	4085	4550	5015	5485	5830
										up to 10 Cyc with front loader*	3490	4010	4605	5195	5790	6385	6975	7420
										10 HT	2545	2830	3355	3785	4220	4650	5085	5405
VF 540/65 R 38 NRO	162 D	DW 20 B	DW 18 L	549	1676	760	4981	800	STD	km/h - bar	0.6	0.8	1.0	1.2	1.4	1.6	2.0	
										70	2200	2545	2890	3285	3585	3890	4320	
										from 65 to 40	2420	2800	3180	3610	3940	4275	4750	
										30	2465	2855	3240	3680	4015	4360	4845	
										20	5215	2910	3305	3750	4095	4445	4940	
										10	2660	3080	3495	3970	4330	4700	5225	
										up to 10 Cyc with front loader*	3385	3920	4450	5050	5515	5985	6650	
										10 HT	2465	2855	3240	3680	4015	4360	4845	
VF 600/60 R 38 NRO	166 D	DW 20 B	DW 18 L	587	1685	757	5081	800	STD	km/h - bar	0.6	0.8	1.0	1.2	1.4	1.6	2.0	
										70	2360	2745	3180	3565	3950	4340	4820	
										from 65 to 40	2595	3020	3495	3920	4345	4770	5300	
										30	2645	3080	3560	3995	4430	4865	5405	
										20	2695	3140	3630	4075	4515	4960	5510	
										10	2850	3320	3840	4310	4775	5245	5830	
										up to 10 Cyc with front loader*	3630	4225	4890	5485	6080	6675	7420	
										10 HT	2645	3080	3560	3995	4430	4865	5405	
VF 600/60 R 38 NRO	168 D	DW 20 B	DW 18 L	587	1685	757	5077	800	STD	km/h - bar	0.6	0.8	1.0	1.2	1.4	1.6	2.0	2.4
										70	2345	2705	3110	3465	3875	4230	4740	5095
										From 65 to 40	2580	2970	3420	3810	4260	4650	5210	5600
										30	2630	3030	3485	3885	4340	4740	5315	5710
										20	2680	3085	3555	3960	4425	4835	5415	5820
										10	2835	3265	3760	4190	4685	5115	5730	6160
										up to 10 Cyc with front loader*	3610	4160	4785	5335	5960	6510	7295	7840
										10 HT	2630	3030	3485	3885	4340	4740	5315	5710
VF 650/60 R 38 NRO	173 D	DW 23 B	DW 21 B	650	1745	774	5217	825	STD	km/h - bar	0.6	0.8	1.0	1.2	1.4	1.6	2.0	2.4
										70	2725	3135	3610	4025	4500	4910	5505	5915
										From 65 to 40	2990	3445	3965	4420	4940	5395	6045	6500
										30	3050	3515	4045	4510	5040	5504	6170	6630
										20	3110	3585	4125	4600	5140	5615	6290	6760
										10	3290	3790	4365	4865	5435	5935	6650	7150
										up to 10 Cyc with front loader*	4190	4825	5555	6190	6920	7555	8465	9100
										10 HT	3050	3515	4045	4510	5040	5505	6170	6630
VF 650/60 R 38 NRO	166 D	DW 23 B	DW 21 B	650	1745	774	5231	825	STD	km/h - bar	0.6	0.8	1.0	1.2	1.4	1.6		
										70	2650	3080	3515	3950	4385	4820		
										from 65 to 40	2915	3390	3865	4345	4820	5300		
										30	2970	3455	3940	4430	4915	5405		
										20	3030	3525	4015	4515	5010	5510		
										10	3205	3725	4250	4775	5300	5830		
										up to 10 Cyc with front loader*	4080	4745	5410	6080	6745	7420		
										10 HT	2970	3455	3940	4430	4915	5405		

STD: Standard

*For up to 10 Cyc with front loader application inflation pressure to be increased by 0.8 bar.

Technologies



Performance





AGRIMAX V-FLECTO (R-1W)

Ø 38"	Tire size	LI/SS	RIM		S.W. (mm)	O.D. (mm)	SLR (mm)	RC (mm)	SRI (index)	Version	Load capacity (kg/tire)						
			Rec. 	Alt. 							km/h - bar	0.6	0.8	1.0	1.2	1.4	1.6
VF 650/65 R 38 NRO	169 D	DW 23 B DW 21 B	650	1811	798	5387	875	STD	70	2950	3480	3955	4430	4850	5275		
									from 65 to 40	3245	3825	4350	4870	5335	5800		
									30	3305	3900	4435	4965	5440	5915		
									20	3370	3975	4520	5060	5545	6030		
									10	3565	4205	4785	5355	5865	6380		
									up to 10 Cyc with front loader*	4540	5355	6090	6815	7465	8120		
									10 HT	3305	3900	4435	4965	5440	5915		
									km/h - bar	0.6	0.8	1.0	1.2	1.4	1.6		
									70	2890	3330	3830	4270	4770	5210	5840	6275
									from 65 to 40	3175	3660	4210	4695	5245	5730	6420	6900
30	3240	3730	4295	4785	5350	5840	6545	7035									
20	3305	3805	4380	4880	5455	5960	6675	7175									
10	3495	4025	4630	5165	5770	6300	7060	7590									
up to 10 Cyc with front loader*	4445	5120	5895	6570	7345	8020	8985	9660									
10 HT	3240	3730	4295	4785	5350	5840	6545	7035									
VF 710/60 R 38 NRO	171 D	DW 25 B DW 23 B	708	1820	794	5447	875	STD	70	3075	3580	4080	4585	5090	5595		
									from 65 to 40	3380	3935	4485	5040	5595	6150		
									30	3445	4010	4570	5140	5705	6270		
									20	3515	4090	4660	5240	5815	6395		
									10	3715	4325	4930	5540	6150	6765		
									up to 10 Cyc with front loader*	4730	5505	6275	7055	7830	8610		
									10 HT	3445	4010	4570	5140	5705	6270		
									km/h - bar	0.6	0.8	1.0	1.2	1.4	1.6		
									70	3750	4350	4950	5625	6225	6825	7505	
									From 65 to 40	4125	4785	5445	6185	6845	7505	8250	
30	4205	4880	5550	6305	6980	7655	8415										
20	4290	4975	5660	6430	7115	7805	8580										
10	4535	5260	5985	6800	7525	8255	9075										
up to 10 Cyc with front loader*	5775	6695	7620	8655	9580	10505	11550										
10 HT	4205	4880	5550	6305	6980	7655	8415										
VF 710/70 R 38	181 D	DW 24 B DW 23 B ; DW 25 B	715	1961	843	5773	925	STD	70	3980	4615	5255	5965	6605	7240	7960	
									From 65 to 40	4375	5075	5775	6560	7260	7960	8750	
									30	4460	5175	5890	6690	7405	8115	8925	
									20	4550	5275	6005	6820	7550	8275	9100	
									10	4810	5580	6350	7215	7985	8755	9625	
									up to 10 Cyc with front loader*	6125	7105	8085	9180	10160	11140	12250	
									10 HT	4460	5175	5890	6690	7405	8115	8925	
									km/h - bar	0.6	0.8	1.0	1.2	1.4	1.6	2.0	
									70	4440	5150	5860	6660	7370	8080	8875	
									From 65 to 40	4875	5655	6435	7315	8095	8875	9750	
30	4975	5770	6565	7460	8255	9050	9945										
20	5070	5885	6695	7605	8420	9230	10140										
10	5365	6225	7080	8045	8905	9760	10725										
up to 10 Cyc with front loader*	6825	7920	9010	10240	11330	12425	13650										
10 HT	4975	5770	6565	7460	8255	9050	9945										
VF 710/75 R 38	183 D	DW 24 B DW 23 B ; DW 25 B	720	2060	905	6151	950	STD	70	4440	5150	5860	6660	7370	8080	8875	
									From 65 to 40	4875	5655	6435	7315	8095	8875	9750	
									30	4975	5770	6565	7460	8255	9050	9945	
									20	5070	5885	6695	7605	8420	9230	10140	
									10	5365	6225	7080	8045	8905	9760	10725	
									up to 10 Cyc with front loader*	6825	7920	9010	10240	11330	12425	13650	
									10 HT	4975	5770	6565	7460	8255	9050	9945	
									km/h - bar	0.6	0.8	1.0	1.2	1.4	1.6	2.0	
									70	4440	5150	5860	6660	7370	8080	8875	
									From 65 to 40	4875	5655	6435	7315	8095	8875	9750	
30	4975	5770	6565	7460	8255	9050	9945										
20	5070	5885	6695	7605	8420	9230	10140										
10	5365	6225	7080	8045	8905	9760	10725										
up to 30 Cyc	5535	6420	7305	8305	9190	10075	11067										
up to 15 Cyc	6610	7665	8720	9910	10970	12025	13212										
up to 10 Cyc*	7240	8400	9560	10860	12020	13180	14479										
10 HT	4975	5770	6565	7460	8255	9050	9945										
VF 800/70 R 38	187 D	DW 28 B DW 25 B ; DW 27 B ; DW 30 B	804	2085	890	6155	975	STD	70	4440	5150	5860	6660	7370	8080	8875	
									From 65 to 40	4875	5655	6435	7315	8095	8875	9750	
									30	4975	5770	6565	7460	8255	9050	9945	
									20	5070	5885	6695	7605	8420	9230	10140	
									10	5365	6225	7080	8045	8905	9760	10725	
									up to 10 Cyc with front loader*	6825	7920	9010	10240	11330	12425	13650	
									10 HT	4975	5770	6565	7460	8255	9050	9945	
									km/h - bar	0.6	0.8	1.0	1.2	1.4	1.6	2.0	
									70	4440	5150	5860	6660	7370	8080	8875	
									From 65 to 40	4875	5655	6435	7315	8095	8875	9750	
30	4975	5770	6565	7460	8255	9050	9945										
20	5070	5885	6695	7605	8420	9230	10140										
10	5365	6225	7080	8045	8905	9760	10725										
up to 30 Cyc	5535	6420	7305	8305	9190	10075	11067										
up to 15 Cyc	6610	7665	8720	9910	10970	12025	13212										
up to 10 Cyc*	7240	8400	9560	10860	12020	13180	14479										
10 HT	4975	5770	6565	7460	8255	9050	9945										
VF 800/70 R 38 CFO	187 D	DW 28 B DW 25 B ; DW 27 B ; DW 30 B	804	2085	890	6155	975	STD	70	4440	5150	5860	6660	7370	8080	8875	
									From 65 to 40	4875	5655	6435	7315	8095	8875	9750	
									30	4975	5770	6565	7460	8255	9050	9945	
									20	5070	5885	6695	7605	8420	9230	10140	
									10	5365	6225	7080	8045	8905	9760	10725	
									up to 30 Cyc	5535	6420	7305	8305	9190	10075	11067	
									up to 15 Cyc	6610	7665	8720	9910	10970	12025	13212	
									up to 10 Cyc*	7240	8400	9560	10860	12020	13180	14479	
									10 HT	4975	5770	6565	7460	8255	9050	9945	

STD: Standard

*For up to 10 Cyc with front loader application inflation pressure to be increased by 0.8 bar.

Technologies



High Speed



Reinforced Bead



VF Technology



Narrow Rim Option

Performance



Fuel Economy



Handling and Comfort



High Load Capacity



Reduced Soil Compaction



Self-Cleaning



Traction



Ø 38"	Tire size	LI/SS	RIM		S.W. (mm)	O.D. (mm)	SLR (mm)	RC (mm)	SRI (index)	Version	Load capacity (kg/tire)										
			Rec.	Alt.							km/h - bar	0.6	0.8	1.0	1.2	1.4	1.6	2.0			
VF900/60 R 38 NRO	187 D	DW 30 B	-	881	2045	882	6053	975	STD	70	4345	5055	5855	6565	7275	7985	8870				
										from 65 to 40	4775	5555	6435	7215	7995	8775	9750				
										30	4870	5665	6560	7355	8150	8950	9945				
										20	4965	5775	6690	7500	8310	9125	10140				
										10	5250	6110	7075	7935	8790	9650	10725				
										up to 10 Cyc with front loader*	6685	7775	9005	10100	11190	12285	13650				
										10 HT	4870	5665	6560	7355	8150	8950	9945				
Ø 42"	VF 520/85 R 42 CFO	180 D	DW 18 L	-	535	1951	876	5841	925	STD	km/h - bar	0.6	0.8	1.0	1.2	1.4	1.6	2.0	2.4	2.8	3.2
											70	2840	3350	3860	4300	4805	5245	5755	6190	6775	7280
											From 65 to 40	3120	3680	4240	4720	5280	5760	6320	6800	7440	8000
											30	3185	3755	4325	4815	5390	5880	6450	6940	7590	8160
											20	3245	3830	4410	4910	5495	5995	6575	7075	7740	8320
											10	3435	4050	4665	5195	5810	6340	6955	7480	8185	8800
											up to 30 Cyc	3545	4180	4815	5360	5995	6540	7175	7720	8445	9080
	up to 15 Cyc	4230	4990	5750	6400	7155	7805	8565	9215	10085	10840										
	up to 10 Cyc	4635	5465	6300	7010	7845	8555	9390	10100	11050	11880										
	10 HT	3185	3755	4325	4815	5390	5880	6450	6940	7590	8160										
	VF 580/85 R 42 CFO	183 D	DW 20B	DW 18B ; MW 20B	606	2058	923	6166	975	STD	km/h - bar	0.6	0.8	1.0	1.2	1.4	1.6	2.0	2.4	2.8	
											70	3425	3980	4540	5095	5655	6210	6850	7245	7960	
											From 65 to 40	3765	4375	4990	5600	6215	6825	7525	7965	8750	
											30	3840	4465	5090	5715	6340	6965	7680	8125	8925	
20											3915	4550	5190	5825	6465	7100	7830	8285	9100		
10											4140	4815	5490	6160	6835	7510	8280	8760	9625		
up to 30 Cyc											4270	4965	5665	6360	7055	7750	8540	9040	9930		
up to 15 Cyc	5100	5930	6760	7590	8420	9250	10200	10790	11855												
up to 10 Cyc	5590	6495	7405	8315	9225	10135	11175	11825	12990												
10 HT	3840	4465	5090	5715	6340	6965	7680	8125	8925												
VF 580/85 R 42 CFO	183 D	DW 20B	DW 18B ; MW 20B	606	2058	923	6166	975	SPL	km/h - bar	0.6	0.8	1.0	1.2	1.4	1.6	2.0	2.4	2.8		
										70	3425	3980	4540	5095	5655	6210	6850	7245	7960		
										From 65 to 40	3765	4375	4990	5600	6215	6825	7525	7965	8750		
										30	3840	4465	5090	5715	6340	6965	7680	8125	8925		
										20	3915	4550	5190	5825	6465	7100	7830	8285	9100		
										10	4140	4815	5490	6160	6835	7510	8280	8760	9625		
										up to 30 Cyc	4270	4965	5665	6360	7055	7750	8540	9040	9930		
up to 15 Cyc	5100	5930	6760	7590	8420	9250	10200	10790	11855												
up to 10 Cyc	5590	6495	7405	8315	9225	10135	11175	11825	12990												
10 HT	3840	4465	5090	5715	6340	6965	7680	8125	8925												
VF 650/60 R 42	174 D	DW 23 B	DW 21 B	660	1845	834	5564	875	STD	km/h - bar	0.6	0.8	1.0	1.2	1.4	1.6	2.0	2.4			
										70	2800	3230	3715	4140	4630	5055	5665	6095			
										From 65 to 40	3080	3550	4085	4555	5090	5560	6230	6700			
										30	3140	3615	4165	4640	5190	5665	6350	6830			
										20	3200	3690	4245	4735	5290	5780	6475	6965			
										10	3390	3905	4495	5010	5600	6115	6850	7370			
										up to 10 Cyc with front loader*	4310	4970	5720	6375	7125	7785	8720	9380			
10 HT	3140	3615	4165	4640	5190	5665	6350	6830													
VF 650/65 R 42 NRO	174 D	DW 23 B	DW 21 B	650	1913	852	5773	925	STD	km/h - bar	0.6	0.8	1.0	1.2	1.4	1.6	2.0				
										70	3105	3590	4080	4630	5055	5485	6095				
										From 65 to 40	3415	3950	4485	5090	5560	6030	6700				
										30	3480	4025	4570	5190	5670	6150	6830				
										20	3350	4105	4660	5290	5780	6270	6965				
										10	3755	4345	4930	5595	6115	6630	7370				
										up to 10 Cyc with front loader*	4780	5530	6275	7125	7780	8440	9380				
10 HT	3480	4025	4570	5190	5670	6150	6830														
VF 710/60 R 42 NRO	173 D	DW 25 B	DW 23 B ; MW 25 B	710	1930	860	5786	925	STD	km/h - bar	0.6	0.8	1.0	1.2	1.4	1.6					
										70	3250	3785	4315	4850	5380	5915					
										From 65 to 40	3575	4160	4745	5330	5915	6500					
										30	3645	4240	4835	5435	6030	6630					
										20	3715	4325	4930	5540	6150	6760					
										10	3930	4575	5215	5860	6505	7150					
										up to 10 Cyc with front loader*	5005	5820	6640	7460	8280	9100					
10 HT	3645	4240	4835	5435	6030	6630															

STD: Standard - SPL: Special

*For up to 10 Cyc with front loader application inflation pressure to be increased by 0.8 bar.

Technologies



High Speed



Reinforced Bead



VF Technology



Narrow Rim Option

Performance



Fuel Economy



Handling and Comfort



High Load Capacity



Reduced Soil Compaction



Self-Cleaning



Traction

AGRIMAX V-FLECTO (R-1W)

Ø 42"	Tire size	LI/SS	RIM		S.W. (mm)	O.D. (mm)	SLR (mm)	RC (mm)	SRI (index)	Version	Load capacity (kg/tire)											
			Rec.	Alt.							km/h - bar	0.6	0.8	1.0	1.2	1.4	1.6	2.0	2.4			
Ø 42"	VF 710/70 R 42	185 D	DW 25 B	DW 23 B; DW 24 B	715	2061	921	6182	975	STD	70	3960	4545	5220	5895	6565	7240	7915	8415			
											From 65 to 40	4350	4995	5735	6475	7215	7955	8695	9250			
											30	4435	5095	5850	6605	7360	8115	8870	9435			
											20	4525	5195	5965	6735	7505	8275	9045	9620			
											10	4785	5495	6310	7125	7940	8755	9565	10175			
											up to 10 Cyc with front loader*	6090	6995	8030	9065	10105	11140	12175	12950			
	10 HT	4435	5095	5850	6605	7360	8115	8870	9435													
	VF 710/70 R 42	193 D	DW 25 B	DW 23 B; DW 24 B	720	2058	921	6182	975	STD	70	3875	4500	5130	5865	6490	7120	7850	8270	9105	9840	10465
											From 65 to 40	4255	4945	5635	6440	7130	7820	8625	9075	10005	10810	11500
											30	4345	5045	5750	6570	7275	7980	8800	9270	10210	11030	11730
											20	4430	5145	5865	6700	7420	8135	8970	9450	10410	11245	11960
											10	4685	5440	6200	7085	7845	8605	9490	9995	11010	11895	12650
up to 10 Cyc with front loader*											5960	6925	7890	9020	9985	10950	12075	12720	14010	15135	16100	
10 HT	4345	5045	5750	6570	7275	7980	8800	9270	10210	11030	11730											
VF 710/75 R 42	184 D	DW 24 B	DW 23 B; DW 25 B	730	2150	937	6412	1000	STD	70	4095	4750	5405	6140	6795	7450	8190	8910				
										From 65 to 40	4500	5220	5940	6750	7470	8190	8910	9000				
										30	4590	5320	6055	6885	7615	8350	9180					
										20	4680	5425	6175	7020	7765	8515	9360					
										10	4950	5740	6530	7425	8215	9005	9900					
										up to 10 Cyc with front loader*	6300	7305	8315	9450	10455	11465	12600					
10 HT	4590	5320	6055	6885	7615	8350	9180															
VF 900/60 R 42 NRO	189 D	DW 30 B	-	900	2142	937	6390	1025	STD	70	4590	5340	6180	6930	7680	8435	9370					
										From 65 to 40	5045	5870	6795	7620	8445	9270	10300					
										30	5145	5985	6930	7770	8610	9455	10505					
										20	5245	6100	7065	7920	8780	9640	10710					
										10	5545	6455	7470	8380	9285	10195	11330					
										up to 10 Cyc with front loader*	7060	8215	9510	10665	11820	12975	14420					
10 HT	5145	5985	6930	7770	8610	9455	10505															
Ø 44"	VF 750/70 R 44	186 D	DW 25 B	DW 24 B	760	2175	958	6450	1025	STD	70	4065	4670	5360	6055	6745	7435	8130	8645			
											From 65 to 40	4465	5130	5890	6650	7410	8170	8930	9500			
											30	4555	5235	6010	6785	7560	8335	9110	9690			
											20	4645	5340	6130	6920	7710	8500	9290	9880			
											10	4915	5645	6480	7315	8155	8990	9825	10450			
											up to 10 Cyc with front loader*	6255	7185	8250	9310	10375	11440	12505	13300			
10 HT	4555	5235	6010	6785	7560	8335	9110	9690														
Ø 46"	VF 520/85 R 46 CFO	173 D	DW 18 L	-	535	2052	911	6111	975	STD	70	2955	3430	3900	4435	4905	5380	5915				
											From 65 to 40	3250	3770	4290	4875	5395	5915	6500				
											30	3315	3845	4375	4970	5500	6030	6630				
											20	3380	3920	4460	5070	5610	6150	6760				
											10	3575	4145	4715	5360	5930	6505	7150				
											up to 30 Cyc	3685	4275	4865	5530	6120	6710	7375				
up to 15 Cyc	4445	5155	5870	6670	7380	8090	8895															
up to 10 Cyc	4825	5595	6365	7235	8005	8780	9650															
10 HT	3315	3845	4375	4970	5500	6030	6630															

STD: Standard

*For up to 10 Cyc with front loader application inflation pressure to be increased by 0.8 bar.

Technologies



Performance





TRACTOR

Radial



AGRIMAX SPARGO (R-1)

AGRIMAX SPARGO is the special BKT tire for row crop applications. It has been designed for enhanced productivity in the fields and for preserving the soil in the long term. Thanks to VF technology, the tire provides higher load capacity at standard pressure. Thanks to a strong casing and an increased number of lugs, AGRIMAX SPARGO ensures outstanding durability along with strong stability both in the fields and during road transfers.

AGRIMAX SPARGO
RADIAL VF SPRAYER TIRES

Ø 34"	Tire size	LI/SS	RIM		S.W. (mm)	O.D. (mm)	SLR (mm)	RC (mm)	SRI (index)	Version	Load capacity (kg/tire)																	
			Rec.	Alt.							km/h - bar	1.2	1.4	1.6	1.8	2.0	2.2	2.4	2.6	2.8	3.0	3.2						
VF 380/85 R 34	160 D	W 13 A	W 12	380	1500	678	4514	725	STD	70	2455	2745	3000	3165	3285	3410	3535	3705	3870	3995	4160							
										From 65 to 40	2655	2970	3240	3420	3555	3690	3825	4005	4185	4320	4500							
										30	2705	3030	3305	3490	3625	3765	3905	4085	4270	4410	4590							
										20	2760	3090	3370	3560	3695	3840	3980	4165	4355	4495	4680							
										10	2920	3265	3565	3765	3910	4060	4210	4405	4605	4755	4950							
VF 380/85 R 38	161 D	W 13 A	W 12	380	1602	730	4830	775	STD	70	2480	2775	3025	3195	3320	3445	3570	3740	3910	4035	4205							
										From 65 to 40	2725	3050	3330	3515	3650	3790	3930	4115	4300	4440	4625							
										30	2780	3110	3390	3580	3720	3865	4005	4195	4380	4525	4715							
										20	2835	3170	3460	3655	3795	3940	4085	4280	4470	4615	4810							
										10	3000	3355	3660	3860	4015	4165	4320	4525	4725	4880	5085							
VF 320/90 R 42	163 D	W 11	W 10 ; DW 10 ; W 10 L ; DW 11	323	1642	764	4995	775	STD	70	2165	2440	2665	2800	2935	3115	3270	3430	3565	3700	3815	3925	4040	4150	4330	4510		
										From 65 to 40	2340	2635	2880	3025	3170	3270	3365	3535	3705	3855	4000	4120	4245	4365	4485	4680	4875	
										30	2390	2690	2940	3085	3235	3335	3435	3610	3785	3935	4080	4205	4330	4455	4580	4780	4975	
										20	2435	2740	2995	3145	3300	3400	3500	3680	3855	4010	4160	4285	4415	4540	4665	4870	5070	
										10	2580	2900	3170	3330	3490	3595	3705	3890	4080	4240	4400	4535	4670	4805	4940	5155	5365	
										70	3675	4070	4465	4660	4925	5055	5185	5450	5715	5910	6170	6370	6565					
										From 65 to 40	3975	4405	4825	5040	5325	5470	5610	5890	6180	6390	6675	6890	7100					
										30	4055	4495	4925	5145	5435	5580	5725	6010	6305	6525	6810	7030	7245					
										20	4135	4580	5020	5245	5540	5690	5835	6130	6425	6650	6940	7165	7385					
										10	4375	4845	5310	5545	5860	6015	6170	6480	6795	7030	7340	7575	7810					
up to 30 Cyclic	4515	5000	5480	5720	6045	6210	6370	6690	7015	7255	7575	7820	8060															
up to 15 Cyclic	5390	5970	6540	6830	7220	7410	7605	7985	8375	8665	9045	9335	9625															
up to 10 Cyclic	5965	6605	7240	7565	7995	8205	8415	8840	9270	9590	10015	10335	10655															
VF 480/80 R 42	176 D	DW 16 L	DW 15 L	479	1835	838	5572	875	STD	70	2835	3190	3485	3665	3480	3960	4080	4315	4495	4670	4850	5025	5145	5320	5440	5675	5915	
										From 65 to 40	3120	3510	3835	4030	4225	4355	4485	4745	4940	5135	5330	5525	5655	5850	5980	6240	6500	
										30	3180	3580	3910	4110	4305	4440	4570	4835	5035	5235	5435	5635	5765	5965	6095	6360	6630	
										20	3240	3650	3985	4190	4390	4525	4660	4930	5135	5340	5540	5745	5880	6080	6215	6485	6760	
										10	3430	3860	4215	4430	4645	4790	4930	5215	5430	5645	5860	6075	6220	6435	6575	6860	7150	
										70	2835	3190	3485	3665	3480	3960	4080	4315	4495	4670	4850	5025	5145	5320	5440	5675	5915	6210
										From 65 to 40	3120	3510	3835	4030	4225	4355	4485	4745	4940	5135	5330	5525	5655	5850	5980	6240	6500	6900
										30	3180	3580	3910	4110	4305	4440	4570	4835	5035	5235	5435	5635	5765	5965	6095	6360	6630	7040
										20	3240	3650	3985	4190	4390	4525	4660	4930	5135	5340	5540	5745	5880	6080	6215	6485	6760	7180
										10	3430	3860	4215	4430	4645	4790	4930	5215	5430	5645	5860	6075	6220	6435	6575	6860	7150	7590

Technologies



VF Technology



More Lugs



Strong Casing

Performance



Handling and Comfort



High Load Capacity



Reduced Soil Compaction



Traction

STD: Standard





AGRIMAX SPARGO (R-1)

Ø 46"	Tire size	LI/SS	RIM		S.W. (mm)	O.D. (mm)	SLR (mm)	RC (mm)	SRI (index)	Version	Load capacity (kg/tire)																		
			Rec.	Alt.							km/h - bar	1.2	1.4	1.6	1.8	2.0	2.2	2.4	2.6	2.8	3.0	3.2	3.4	3.6					
											70	From 65 to 40	30	20	10														
VF 480/80 R 46	177 D	DW 16 L	DW 15 L	479	1936	892	5907	925	STD	70	3715	4115	4515	4710	4980	5110	5245	5510	5775	5975	6240	6440	6640						
										From 65 to 40	4085	4525	4960	5180	5475	5620	5765	6055	6350	6570	6860	7080	7300						
										30	4165	4615	5060	5285	5580	5730	5880	6175	6475	6700	6995	7220	7445						
										20	4250	4705	5160	5385	5690	5840	5995	6295	6600	6830	7130	7360	7590						
										10	4495	4975	5460	5700	6020	6180	6340	6660	6985	7225	7545	7785	8030						
VF 320/90 R 50	169 D	W 11	W 10 ; DW 10 ; W 10 L ; DW 11	323	1846	865	5650	900	STD	70	2415	2685	2955	3085	3220	3330	3435	3595	3760	3810	3865	4105	4350	4455	4565	4775	4990	5365	
										From 65 to 40	2610	2900	3190	3335	3480	3600	3715	3890	4060	4120	4180	4440	4700	4815	4930	5165	5395	5800	
										30	2665	2960	3260	3405	3555	3675	3790	3970	4145	4205	4265	4530	4800	4915	5035	5270	5510	5920	
										20	2720	3020	3320	3475	3625	3745	3865	4045	4225	4285	4350	4620	4890	5010	5130	5375	5615	6035	
										10	2875	3190	3510	3670	3830	3960	4085	4275	4470	4530	4595	4885	5170	5300	5425	5680	5935	6380	
VF 380/105 R 50	179 D	W 13 A	W 12 ; DW 12 ; DW 13 ; DW 13 L	400	2050	934	6211	1000	STD	70	3380	3805	4155	4370	4580	4720	4860	5145	5355	5565	5780	5990	6130	6345	6485	6765	7050		
										From 65 to 40	3720	4185	4570	4805	5035	5190	5345	5655	5890	6120	6355	6585	6740	6975	7130	7440	7550		
										30	3790	4265	4660	4990	5135	5295	5450	5770	6005	6240	6480	6715	6875	7110	7270	7585	7905		
										20	3865	4350	4755	4995	5235	5400	5560	5880	6125	6365	6605	6850	7010	7250	7415	7735	8060		
										10	4090	4600	5025	5285	5540	5710	5880	6220	6475	6730	6990	7245	7415	7670	7840	8180	8525		
VF 380/90 R 50	175 D	W13 B	W12 B	390	1950	893	5950	950	STD	70	3010	3385	3700	3890	4075	4200	4325	4580	4765	4955	5145	5330	5455	5645	5770	6020	6275		
										From 65 to 40	3310	3725	4070	4275	4485	4620	4760	5035	5240	5450	5655	5865	6000	6210	6345	6620	6900		
										30	3375	3795	4150	4360	4570	4710	4850	5135	5345	5555	5765	5975	6120	6330	6470	6750	7035		
										20	3440	3870	4230	4445	4660	4805	4950	5235	5450	5665	5880	6095	6240	6455	6600	6885	7175		
										10	3640	4095	4475	4705	4930	5085	5235	5540	5765	5995	6220	6450	6600	6830	6980	7285	7590		
VF 420/95 R 50	177 D	DW 14	DW 13 ; W 13 ; W 14	419	2068	943	6210	1000	STD	70	3715	4115	4515	4710	4980	5110	5245	5510	5775	5975	6240	6440	6640						
										From 65 to 40	4085	4525	4960	5180	5475	5620	5765	6055	6350	6570	6860	7080	7300						
										30	4165	4615	5060	5285	5580	5730	5880	6175	6475	6700	6995	7220	7445						
										20	4250	4705	5160	5385	5690	5840	5995	6295	6600	6830	7130	7360	7590						
										10	4495	4975	5460	5700	6020	6180	6340	6660	6985	7225	7545	7785	8030						
VF 480/80 R 50	179 D	DW 16 L	DW 15 L	479	2038	947	6224	975	STD	70	3945	4370	4790	5005	5285	5425	5565	5850	6130	6345	6625	6835	7050						
										From 65 to 40	4340	4805	5270	5500	5810	5965	6120	6430	6740	6975	7285	7515	7750						
										30	4425	4900	5375	5610	5925	6085	6240	6560	6875	7110	7430	7665	7905						
										20	4510	4995	5480	5720	6045	6205	6365	6685	7010	7250	7575	7815	8060						
										10	4770	5285	5795	6050	6390	6560	6730	7075	7415	7670	8010	8265	8525						
Ø 54"	VF 320/90 R 54	168 D	W 11	W 10 ; DW 10 ; W 10 L ; DW 11	323	1948	910	5946	950	STD	70	2230	2490	2800	3060	3215	3370	3475	3575	3760	3940	4095	4250	4380	4510	4640	4770	4975	5180
											From 65 to 40	2410	2690	3025	3305	3475	3640	3755	3865	4060	4260	4425	4595	4735	4875	5015	5155	5380	5600
											30	2460	2745	3090	3375	3545	3715	3830	3945	4145	4345	4515	4690	4830	4975	5115	5260	5490	5715
											20	2505	2800	3150	3440	3615	3790	3905	4020	4225	4430	4605	4780	4925	5070	5215	5360	5595	5825
											10	2650	2960	3330	3635	3820	4005	4130	4255	4470	4685	4870	5055	5210	5360	5515	5670	5915	6160

STD: Standard

Technologies



VF Technology



More Lugs



Strong Casing

Performance



Handling and Comfort



High Load Capacity



Reduced Soil Compaction



Traction

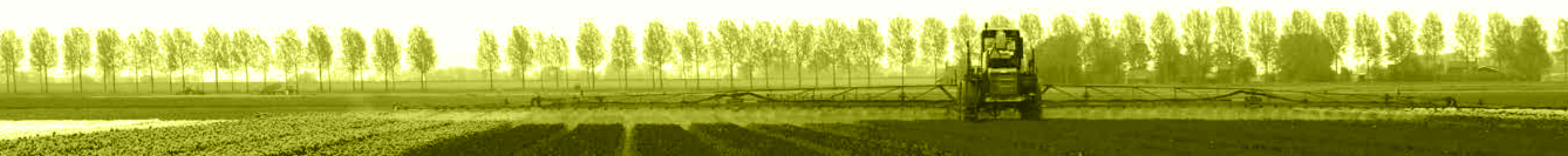



AGRIMAX FORCE (R-1W)

AGRIMAX FORCE, the high-end product of BKT, is a radial tire specially designed for soil tillage, haulage and harvesting applications with high-power tractors and harvesters, ensuring top performance and efficiency. Thanks to its IF technology, this tire can carry heavy loads with a lower inflating pressure compared to a standard tire reducing soil compaction. AGRIMAX FORCE features a reinforced bead and provides enhanced traction, top self-cleaning properties and fuel economy in addition to a comfortable riding experience.

AGRIMAX FORCE
RADIAL 1^{IF} TECHNOLOGY TIRES

Ø 28"	Tire size	LI/SS	RIM		S.W. (mm)	O.D. (mm)	SLR (mm)	RC (mm)	SRI (index)	Version	Load capacity (kg/tire)							
			Rec.	Alt.							km/h - bar							
											0.6	0.8	1.0	1.2	1.4	1.6	2.0	2.4
IF 600/70 R 28	164 D	DW 21 B	DW 20 B	603	1551	694	4654	725	STD	70	2135	2455	2820	3185	3545	3910	4275	4550
										from 65 to 40	2350	2700	3100	3500	3900	4300	4700	5000
										30	2440	2805	3220	3640	4055	4470	4885	5200
										20	2535	2915	3345	3780	4210	4640	5075	5400
										10	2980	3425	3935	4445	4950	5460	5965	6350
										up to 10 Cyc with front loader*	3290	3780	4340	4900	5460	6020	6580	7000
										10 HT	2440	2805	3220	3640	4055	4470	4885	5200
										km/h - bar	0.6	0.8	1.0	1.2	1.4	1.6	2.0	2.4
										70	2150	2475	2855	3185	3555	3885	4350	4685
										from 65 to 40	2365	2725	3140	3500	3910	4270	4785	5150
30	2455	2830	3265	3640	4065	4440	4975	5355										
20	2550	2940	3390	3780	4220	4610	5165	5560										
10	3000	3460	3985	4445	4965	5420	6075	6540										
up to 30 Cyc	3070	3540	4080	4550	5080	5550	6220	6695										
up to 15 Cyc	3665	4220	4865	5425	6060	6615	7415	7980										
up to 10 Cyc	4020	4630	5335	5950	6645	7255	8130	8755										
10 HT	2455	2830	3265	3640	4065	4440	4975	5355										
IF 710/55 R 28 CFO	165 D	DW 25 B	-	716	1493	663	4442	700	STD	70	2150	2475	2855	3185	3555	3885	4350	4685
										from 65 to 40	2365	2725	3140	3500	3910	4270	4785	5150
										30	2455	2830	3265	3640	4065	4440	4975	5355
										20	2550	2940	3390	3780	4220	4610	5165	5560
										10	3000	3460	3985	4445	4965	5420	6075	6540
										up to 30 Cyc	3070	3540	4080	4550	5080	5550	6220	6695
										up to 15 Cyc	3665	4220	4865	5425	6060	6615	7415	7980
										up to 10 Cyc	4020	4630	5335	5950	6645	7255	8130	8755
										10 HT	2455	2830	3265	3640	4065	4440	4975	5355
										IF 600/70 R 30 CFO	165 D	DW 21 B ; DW 21 A	DW 20 A ; DW 20 B	603	1602	708	4800	750
from 65 to 40	2420	2780	3190	3605	4015	4425	4840	5150										
30	2515	2890	3315	3745	4175	4600	5030	5355										
20	2610	3000	3445	3890	4335	4775	5225	5560										
10	3070	3530	4050	4575	5095	5615	6145	6540										
up to 30 Cyc	3145	3610	4145	4685	5215	5750	6290	6695										
up to 15 Cyc	3750	4305	4940	5585	6220	6855	7500	7980										
up to 10 Cyc	4110	4725	5420	6125	6825	7520	8225	8755										
10 HT	2515	2890	3315	3745	4175	4600	5030	5355										
IF 600/70 R 30 CFO	165 D	DW 21 B ; DW 21 A	DW 20 A ; DW 20 B	603	1602	708	4800	750	SPL									
										from 65 to 40	2420	2780	3190	3605	4015	4425	4840	5150
										30	2515	2890	3315	3745	4175	4600	5030	5355
										20	2610	3000	3445	3890	4335	4775	5225	5560
										10	3070	3530	4050	4575	5095	5615	6145	6540
										up to 30 Cyc	3145	3610	4145	4685	5215	5750	6290	6695
										up to 15 Cyc	3750	4305	4940	5585	6220	6855	7500	7980
										up to 10 Cyc	4110	4725	5420	6125	6825	7520	8225	8755
										10 HT	2515	2890	3315	3745	4175	4600	5030	5355
										IF 620/75 R 30 CFO	169 D	DW 23 B	DW 21 B	650	1703	759	5100	800
from 65 to 40	2725	3130	3595	4060	4520	4985	5450	5800										
30	2830	3288	3735	4220	4700	5180	5665	6030										
20	2940	3380	3880	4380	4880	5380	5885	6260										
10	3460	3975	4565	5155	5740	6330	6920	7365										
up to 30 Cyc	3540	4065	4670	5275	5875	6480	7085	7540										
up to 15 Cyc	4220	4850	5570	6290	7005	7725	8445	8990										
up to 10 Cyc	4630	5320	6110	6900	7680	8470	9265	9860										
10 HT	2830	3255	3735	4220	4700	5180	5665	6030										

STD: Standard - SPL: Special

*For up to 10 Cyc with front loader application inflation pressure to be increased by 0.8 bar.

Technologies



Performance





AGRIMAX FORCE (R-1W)

Ø 30"	Tire size	LI/SS	RIM		S.W. (mm)	O.D. (mm)	SLR (mm)	RC (mm)	SRI (index)	Version	Load capacity (kg/tire)																																																																																																	
			Rec.	Alt.							km/h - bar	0.6	0.8	1.0	1.2	1.4	1.6	2.0	2.4																																																																																									
											70	from 65 to 40	30	20	10	up to 30 Cyc	up to 15 Cyc	up to 10 Cyc	10 HT	70	from 65 to 40	30	20	10	up to 30 Cyc	up to 15 Cyc	up to 10 Cyc	10 HT																																																																																
IF 710/55 R 30 CFO	166 D	DW 25 B	-	716	1544	686	4616	725	STD	km/h - bar	0.6	0.8	1.0	1.2	1.4	1.6	2.0	2.4	70	2215	2550	2930	3275	3660	3995	4480	4820	from 65 to 40	2435	2805	3230	3600	4025	4395	4925	5300	30	2530	2915	3355	3740	4185	4570	5120	5510	20	2625	3025	3485	3885	4345	4745	5315	5720	10	3090	3560	4100	4570	5110	5580	6250	6730	up to 30 Cyc	3165	3645	4195	4680	5230	5710	6400	6890	up to 15 Cyc	3770	4345	5005	5580	6235	6810	7630	8215	up to 10 Cyc	4135	4765	5490	6120	6840	7470	8370	9010	10 HT	2530	2915	3355	3740	4185	4570	5120	5510									
										km/h - bar	0.6	0.8	1.0	1.2	1.4	1.6	2.0	2.4	70	2340	2695	3105	3460	3870	4225	4735	5095	from 65 to 40	2575	2965	3415	3805	4255	4645	5205	5600	30	2675	3080	3550	3955	4425	4830	5410	5820	20	2780	3200	3685	4105	4595	5015	5620	6045	10	3270	3765	4335	4830	5400	5895	6610	7110	up to 30 Cyc	3345	3850	4435	4945	5530	6035	6765	7280	up to 15 Cyc	3990	4595	5290	5895	6595	7195	8065	8680	up to 10 Cyc	4375	5040	5805	6465	7230	7895	8845	9520	10 HT	2675	3080	3550	3955	4425	4830	5410	5820									
										km/h - bar	0.6	0.8	1.0	1.2	1.4	1.6	2.0	2.4	70	2325	2675	3070	3470	3865	4260	4655	4955	from 65 to 40	2560	2940	3375	3815	4250	4685	5120	5450	30	2660	3055	3510	3965	4420	4870	5320	5665	20	2760	3175	3645	4120	4590	5055	5525	5885	10	3250	3730	4285	4845	5395	5945	6500	6920	up to 10 Cyc with front loader*	3580	4115	4725	5340	5950	6555	7165	7630	10 HT	2660	3055	3510	3965	4420	4870	5320	5665																											
										km/h - bar	0.6	0.8	1.0	1.2	1.4	1.6	2.0	2.4	70	2150	2475	2855	3185	3555	3885	4350	4685	from 65 to 40	2365	2725	3140	3500	3910	4270	4785	5150	30	2455	2830	3265	3640	4065	4440	4975	5355	20	2550	2940	3390	3780	4220	4610	5165	5560	10	3000	3460	3985	4445	4965	5420	6075	6540	up to 10 Cyc with front loader*	3310	3815	4395	4900	5470	5975	6695	7210	10 HT	2455	2830	3265	3640	4065	4440	4975	5355																											
										km/h - bar	0.6	0.8	1.0	1.2	1.4	1.6	2.0	2.4	70	2355	2775	3150	3535	3935	4340	4750	5165	from 65 to 40	2590	3050	3465	3885	4315	4755	5205	5665	30	2690	3170	3600	4040	4495	4965	5440	5925	20	2795	3290	3740	4195	4665	5150	5645	6155	10	3285	3870	4450	5035	5630	6235	6855	7485	up to 30 Cyc	3365	3965	4500	5050	5610	6185	6780	7395	up to 15 Cyc	4010	4725	5370	6020	6690	7380	8095	8830	up to 10 Cyc	4400	5185	5890	6600	7330	8095	8895	9715	10HT	2690	3170	3600	4040	4495	4965	5440	5925									
										km/h - bar	0.6	0.8	1.0	1.2	1.4	1.6	2.0	2.4	70	2355	2775	3150	3535	3935	4340	4750	5165	from 65 to 40	2590	3050	3465	3885	4315	4755	5205	5665	30	2690	3170	3600	4040	4495	4965	5440	5925	20	2795	3290	3740	4195	4665	5150	5645	6155	10	3285	3870	4450	5035	5630	6235	6855	7485	up to 30 Cyc	3365	3965	4500	5050	5610	6185	6780	7395	up to 15 Cyc	4010	4725	5370	6020	6690	7380	8095	8830	up to 10 Cyc	4400	5185	5890	6600	7330	8095	8895	9715	10HT	2690	3170	3600	4040	4495	4965	5440	5925									
										km/h - bar	0.6	0.8	1.0	1.2	1.4	1.6	2.0	2.4	70	2290	2675	3000	3385	3765	4145	4640	4965	5460	from 65 to 40	2520	2940	3300	3720	4140	4560	5100	5460	6000	30	2620	3055	3430	3865	4305	4740	5300	5675	6240	20	2720	3175	3560	4015	4470	4920	5505	5895	6480	10	3200	3730	4190	4720	5255	5770	6475	6930	7620	up to 30 Cyc	3275	3820	4290	4835	5380	5925	6630	7095	7800	up to 15 Cyc	3905	4555	5115	5765	6415	7065	7905	8460	9300	up to 10 Cyc	4280	4995	5610	6320	7035	7750	8670	9280	10200	10 HT	2620	3055	3430	3865	4305	4740	5300	5675	6240

STD: Standard - SPL: Special



*For up to 10 Cyc with front loader application inflation pressure to be increased by 0.8 bar.

Technologies



Performance





TRACTOR

AGRIMAX FORCE (R-1W)

Ø 34"	Tire size	LI/SS	RIM		S.W. (mm)	O.D. (mm)	SLR (mm)	RC (mm)	SRI (index)	Version	Load capacity (kg/tire)																		
			Rec.	Alt.							km/h - bar	0.6	0.8	1.0	1.2	1.4	1.6	2.0	2.4										
IF 710/60 R 34 CFO	170 D	DW 25 B	-	708	1716	763	5126	825	STD	km/h - bar	0.6	0.8	1.0	1.2	1.4	1.6	2.0	2.4											
										70	2510	2890	3330	3710	4145	4530	5075	5460											
										from 65 to 40	2760	3180	3660	4080	4560	4980	5580	6000											
										30	2870	3305	3805	4240	4740	5175	5800	6240											
										20	2980	3430	3950	4405	4920	5375	6025	6420											
										10	3505	4035	4645	5180	5790	6320	7085	7625											
										up to 30 Cyc	3585	4130	4755	5300	5925	6470	7250	7800											
										up to 15 Cyc	4275	4925	5670	6320	7065	7715	8645	9300											
										up to 10 Cyc	4690	5405	6220	6935	7750	8465	9485	10200											
										10 HT	2870	3305	3805	4240	4740	5175	5800	6240											
IF 710/60 R 34 CFO	170 D	DW 25 B	-	708	1716	763	5126	825	SPL	km/h - bar	0.6	0.8	1.0	1.2	1.4	1.6	2.0	2.4											
										70	2510	2890	3330	3710	4145	4530	5075	5460											
										from 65 to 40	2760	3180	3660	4080	4560	4980	5580	6000											
										30	2870	3305	3805	4240	4740	5175	5800	6240											
										20	2980	3430	3950	4405	4920	5375	6025	6420											
										10	3505	4035	4645	5180	5790	6320	7085	7625											
										up to 30 Cyc	3585	4130	4755	5300	5925	6470	7250	7800											
										up to 15 Cyc	4275	4925	5670	6320	7065	7715	8645	9300											
										up to 10 Cyc	4690	5405	6220	6935	7750	8465	9485	10200											
										10 HT	2870	3305	3805	4240	4740	5175	5800	6240											
IF 710/75 R 34 CFO	178 D	DW 25 B	DW 23 B	716	1929	870	5775	900	STD	km/h - bar	0.6	0.8	1.0	1.2	1.4	1.6	2.0	2.4											
										70	3205	3685	4230	4775	5320	5865	6415	6825											
										from 65 to 40	3525	4050	4650	5250	5850	6450	7050	7500											
										30	3665	4210	4835	5460	6080	6705	7330	7800											
										20	3805	4370	5020	5670	6315	6965	7610	8100											
										10	4475	5140	5905	6665	7425	8190	8950	9525											
										up to 30 Cyc	4580	5265	6045	6825	7605	8385	9165	9750											
										up to 15 Cyc	5460	6275	7205	8135	9065	9995	10925	11625											
										up to 10 Cyc	5990	6885	7905	8925	9945	10965	11985	12750											
										10 HT	3665	4210	4835	5460	6080	6705	7330	7800											
Ø 38"	IF 380/80 R 38	149 D	W 12	W 11 ; W 13	380	1573	725	4793	750	STD	km/h - bar	0.6	0.8	1.0	1.2	1.4	1.6	2.0	2.4										
											70	1385	1595	1830	2070	2305	2540	2780	2955										
											From 65 to 40	1525	1755	2015	2275	2535	2795	3055	3250										
											30	1585	1825	2095	2365	2635	2905	3175	3380										
											20	1645	1895	2175	2455	2735	3015	3295	3510										
											10	1935	2225	2555	2885	3215	3545	3875	4125										
											up to 10 Cyc with front loader*	2135	2455	2820	3185	3545	3910	4275	4550										
											10HT	1585	1825	2095	2365	2635	2905	3175	3380										
											IF 420/85 R 38	155 D	DW 14 L	DW 15 L	419	1670	780	5017	800	STD	km/h - bar	0.6	0.8	1.0	1.2	1.4	1.6	2.0	2.4
																					70	1655	1900	2180	2465	2745	3030	3310	3525
from 65 to 40	1820	2090	2400	2710	3020	3330	3640	3875																					
30	1890	2170	2495	2815	3140	3460	3785	4030																					
20	1965	2255	2590	2925	3260	3595	3930	4185																					
10	2310	2650	3045	3440	3835	4225	4620	4920																					
up to 10 Cyc with front loader*	2545	2925	3360	3790	4225	4660	5095	5425																					
10 HT	1890	2170	2495	2815	3140	3460	3785	4030																					
IF 650/65 R 38 CFO	169 D	DW 23 B	-	650	1830	830	5510	875	STD	km/h - bar											0.6	0.8	1.0	1.2	1.4	1.6	2.0	2.4	
										70											2475	2900	3320	3690	4060	4375	4900	5275	
										From 65 to 40	2725	3190	3650	4060	4465	4810	5390	5800											
										30	2830	3315	3795	4220	4640	5000	5605	6030											
										20	2940	3445	3940	4380	4820	5190	5820	6260											
										10	3460	4050	4635	5155	5670	6105	6845	7365											
										up to 30 Cyc	3540	4145	4745	5275	5800	6250	7005	7540											
										up to 15 Cyc	4220	4940	5655	6290	6920	7455	8350	8990											
										up to 10 Cyc	4630	5420	6025	6900	7590	8175	9160	9860											
										10HT	2830	3315	3795	4220	4640	5000	5605	6030											

STD: Standard - SPL: Special

*For up to 10 Cyc with front loader application inflation pressure to be increased by 0.8 bar.

Technologies



High Speed



IF Technology



Reinforced Bead

Performance



Fuel Economy



Handling and Comfort



High Load Capacity



Reduced Soil Compaction



Self-Cleaning



Traction



TRACTOR

AGRIMAX FORCE (R-1W)

Ø 38"	Tire size	LI/SS	RIM		S.W. (mm)	O.D. (mm)	SLR (mm)	RC (mm)	SRI (index)	Version	Load capacity (kg/tire)																									
			Rec.	Alt.							km/h - bar	0.6	0.8	1.0	1.2	1.4	1.6	2.0	2.4																	
											70	from 65 to 40	30	20	10	up to 30 Cyc	up to 15 Cyc	up to 10 Cyc	10 HT	70	from 65 to 40	30	20	10	up to 30 Cyc	up to 15 Cyc	up to 10 Cyc	10 HT								
IF 650/75 R 38 CFO	175 D	DW 23 B	DW 21 B	651	1941	866	5802	925	STD	km/h - bar	0.6	0.8	1.0	1.2	1.4	1.6	2.0	2.4	70	2955	3395	3895	4400	4900	5405	5905	6280									
										from 65 to 40	3245	3730	4280	4830	5385	5935	6490	6900	30	3375	3880	4455	5030	5605	6175	6750	7180	20	3505	4030	4625	5220	5815	6415	7010	7455
										10	4120	4735	5435	6140	6840	7540	8240	8765	up to 30 Cyc	4220	4845	5565	6280	7000	7715	8435	8970	up to 15 Cyc	5030	5780	6635	7490	8345	9200	10055	10695
										up to 10 Cyc	5515	6335	7275	8215	9150	10090	11030	11730	10 HT	3375	3880	4455	5030	5605	6175	6750	7180	km/h - bar	0.6	0.8	1.0	1.2	1.4	1.6	2.0	2.4
										70	3310	3805	4370	4935	5500	6065	6625	7050	from 65 to 40	3640	4185	4805	5425	6045	6665	7285	7750	30	3785	4350	4995	5640	6285	6930	7575	8060
										20	3930	4515	5185	5855	6525	7195	7865	8370	10	4620	5310	6100	6885	7675	8460	9250	9840	up to 30 Cyc	4730	5440	6245	7050	7855	8660	9470	10075
										up to 30 Cyc	4730	5440	6245	7050	7855	8660	9470	10075	up to 15 Cyc	5640	6485	7445	8405	9365	10330	11290	12010	up to 10 Cyc	6185	7110	8165	9220	10275	11330	12380	13175
										up to 10 Cyc	6185	7110	8165	9220	10275	11330	12380	13175	10 HT	3785	4350	4995	5640	6285	6930	7575	8060	km/h - bar	0.6	0.8	1.0	1.2	1.4	1.6	2.0	2.4
										70	2630	3030	3490	3890	4350	4750	5325	5730	from 65 to 40	2895	3335	3840	4280	4785	5225	5855	6300	30	3010	3465	3990	4450	4975	5430	6085	6550
										20	3125	3600	4145	4620	5165	5640	6320	6800	10	3675	4235	4875	5435	6075	6635	7335	7800	up to 10 Cyc with front loader*	4050	4665	5375	5990	6695	7315	8195	8820
										up to 10 Cyc with front loader*	4050	4665	5375	5990	6695	7315	8195	8820	10 HT	3010	3465	3990	4450	4975	5430	6085	6550	km/h - bar	0.6	0.8	1.0	1.2	1.4	1.6	2.0	2.4
70	3845	4500	5155	5730	6305	6795	7615	8190	from 65 to 40	4230	4950	5670	6300	6930	7470	8370	9000	30	4395	5145	5895	6550	7205	7765	8700	9360										
20	4565	5345	6120	6800	7480	8065	9035	9720	10	5370	6285	7200	8000	8800	9485	10625	11430	up to 30 Cyc	5495	6435	7370	8190	9005	9710	10880	11700										
up to 30 Cyc	5495	6435	7370	8190	9005	9710	10880	11700	up to 15 Cyc	6555	7670	8785	9765	10740	11575	12970	13950	up to 10 Cyc	7190	8415	9635	10710	11780	12695	14225	15300										
up to 10 Cyc	7190	8415	9635	10710	11780	12695	14225	15300	10 HT	4395	5145	5895	6550	7205	7765	8700	9360	km/h - bar	0.6	0.8	1.0	1.2	1.4	1.6	2.0	2.4										
70	3765	4340	4995	5565	6220	6795	7615	8190	from 65 to 40	4140	4770	5490	6120	6840	7470	8370	9000	30	4305	4960	5705	6360	7110	7765	8700	9360										
20	4470	5150	5925	6605	7385	8065	9035	9720	10	5255	6055	6970	7770	8685	9485	10625	11430	up to 30 Cyc	5380	6200	7135	7955	8890	9710	10880	11700										
up to 30 Cyc	5380	6200	7135	7955	8890	9710	10880	11700	up to 15 Cyc	6415	7390	8505	9485	10600	11575	12970	13950	up to 10 Cyc	7035	8105	9330	10400	11625	12695	14225	15300										
up to 10 Cyc	7035	8105	9330	10400	11625	12695	14225	15300	10 HT	4305	4960	5705	6360	7110	7765	8700	9360	km/h - bar	0.6	0.8	1.0	1.2	1.4	1.6	2.0	2.4										
70	3420	3930	4510	5095	5675	6260	6840	7280	from 65 to 40	3760	4320	4960	5600	6240	6880	7520	8000	30	3910	4490	5155	5820	6485	7155	7820	8320										
20	4060	4665	5355	6045	6735	7430	8120	8640	10	4775	5485	6295	7110	7920	8735	9550	10160	up to 30 Cyc	4885	5615	6445	7280	8110	8940	9775	10400										
up to 30 Cyc	4885	5615	6445	7280	8110	8940	9775	10400	up to 15 Cyc	5825	6695	7685	8680	9670	10660	11655	12400	up to 10 Cyc	6390	7340	8430	9520	10605	11695	12780	13600										
up to 10 Cyc	6390	7340	8430	9520	10605	11695	12780	13600	10 HT	3910	4490	5155	5820	6485	7155	7820	8320																			

STD: Standard

*For up to 10 Cyc with front loader application inflation pressure to be increased by 0.8 bar.

Technologies



Performance





AGRIMAX FORCE (R-1W)

Ø 42"	Tire size	LI/SS	RIM		S.W. (mm)	O.D. (mm)	SLR (mm)	RC (mm)	SRI (index)	Version	Load capacity (kg/tire)								
			Rec.	Alt.							km/h - bar	0.6	0.8	1.0	1.2	1.4	1.6	2.0	2.4
IF 710/70 R 42 CFO	179 D	DW 25 B DW 23 B	716	2061	919	6168	975	STD	km/h - bar	0.6	0.8	1.0	1.2	1.4	1.6	2.0	2.4		
									70	3310	3805	4370	4935	5500	6065	6625	7050		
									from 65 to 40	3640	4185	4805	5425	6045	6665	7285	7750		
									30	3785	4350	4995	5640	6285	6930	7575	8060		
									20	3930	4515	5185	5855	6525	7195	7865	8370		
									10	4620	5310	6100	6885	7675	8460	9250	9840		
									up to 30 Cyc	4730	5440	6245	7050	7855	8660	9470	10075		
									up to 15 Cyc	5640	6485	7445	8405	9365	10330	11290	12010		
									up to 10 Cyc	6185	7110	8165	9220	10275	11330	12380	13175		
									10 HT	3785	4350	4995	5640	6285	6930	7575	8060		
IF 710/70 R 42 CFO	179 D	DW 25 B DW 23 B	716	2061	919	6168	975	SPL	km/h - bar	0.6	0.8	1.0	1.2	1.4	1.6	2.0	2.4		
									70	3310	3805	4370	4935	5500	6065	6625	7050		
									from 65 to 40	3640	4185	4805	5425	6045	6665	7285	7750		
									30	3785	4350	4995	5640	6285	6930	7575	8060		
									20	3930	4515	5185	5855	6525	7195	7865	8370		
									10	4620	5310	6100	6885	7675	8460	9250	9840		
									up to 30 Cyc	4730	5440	6245	7050	7855	8660	9470	10075		
									up to 15 Cyc	5640	6585	7445	8405	9365	10330	11290	12010		
									up to 10 Cyc	6185	7110	8165	9220	10275	11330	12380	13175		
									10 HT	3785	4350	4995	5640	6285	6930	7575	8060		
IF 710/75 R 42 CFO	181 D	DW 25 B DW 23 B	716	2133	967	6403	1000	STD	km/h - bar	0.6	0.8	1.0	1.2	1.4	1.6	2.0	2.4		
									70	3525	4050	4650	5255	5855	6455	7055	7505		
									from 65 to 40	3875	4455	5115	5775	6435	7095	7755	8250		
									30	4030	4630	5315	6005	6690	7375	8065	8580		
									20	4185	4810	5520	6235	6945	7660	8375	8910		
									10	4920	5655	6495	7330	8170	9010	9845	10475		
									up to 30 Cyc	5035	5790	6645	7505	8365	9220	10080	10725		
									up to 15 Cyc	6005	6905	7925	8950	9970	10995	12020	12785		
									up to 10 Cyc	6585	7570	8695	9815	10935	12060	13180	14025		
									10 HT	4030	4630	5315	6005	6690	7375	8065	8580		
IF 710/75 R 42 CFO	181 D	DW 25 B DW 23 B	716	2133	967	6403	1000	SPL	km/h - bar	0.6	0.8	1.0	1.2	1.4	1.6	2.0	2.4		
									70	3525	4050	4650	5255	5855	6455	7055	7505		
									from 65 to 40	3875	4455	5115	5775	6435	7095	7755	8250		
									30	4030	4630	5315	6005	6690	7375	8065	8580		
									20	4185	4810	5520	6235	6945	7660	8375	8910		
									10	4920	5655	6495	7330	8170	9010	9845	10475		
									up to 30 Cyc	5035	5790	6645	7505	8365	9220	10080	10725		
									up to 15 Cyc	6005	6905	7925	8950	9970	10995	12020	12785		
									up to 10 Cyc	6585	7570	8695	9815	10935	12060	13180	14025		
									10 HT	4030	4630	5315	6005	6690	7375	8065	8580		
IF 800/70 R 42 CFO	186 D	DW 27 B DW 28 B, DW 30 B	794	2150	950	6400	1025	STD	km/h - bar	0.6	0.8	1.0	1.2	1.4	1.6	2.0	2.4		
									70	4060	4665	5355	6050	6740	7430	8125	8645		
									from 65 to 40	4465	5130	5890	6650	7410	8170	8930	9500		
									30	4640	5335	6125	6915	7705	8495	9285	9880		
									20	4820	5540	6360	7180	8000	8820	9640	10260		
									10	5670	6515	7480	8445	9410	10375	11340	12065		
									up to 30 Cyc	5800	6665	7655	8645	9630	10620	11605	12350		
									up to 15 Cyc	6920	7950	9125	10305	11485	12660	13840	14725		
									up to 10 Cyc	7590	8720	10010	11305	12595	13885	15180	16150		
									10HT	4640	5335	6125	6915	7705	8495	9285	9880		
IF 800/70 R 42 CFO	192 D	DW 27 B DW 28 B, DW 30 B	794	2150	950	6400	1025	STD	km/h - bar	0.6	0.8	1.0	1.2	1.4	1.6	2.0	2.4	2.8	3.2
									70	3980	4690	5405	6020	6730	7345	8055	8670	9485	10195
									from 65 to 40	4370	5155	5940	6610	7395	8065	8850	9520	10420	11200
									30	4545	5360	6175	6875	7690	8390	9205	9905	10835	11650
									20	4720	5570	6415	7140	7990	8715	9560	10285	11255	12100
									10	5550	6545	7540	8395	9390	10245	11240	12095	13230	14225
									up to 30 Cyc	5680	6700	7720	8595	9610	10485	11505	12380	13545	14560
									up to 15 Cyc	6775	7990	9205	10245	11460	12500	13715	14760	16145	17360
									up to 10 Cyc	7430	8760	10095	11235	12570	13710	15045	16185	17710	19040
									10HT	4545	5360	6175	6875	7690	8390	9205	9905	10835	11650

Technologies



Performance



STD: Standard - SPL: Special



AGRIMAX FORCE (R-1W)

Ø 42"	Tire size	LI/SS	RIM		S.W. (mm)	O.D. (mm)	SLR (mm)	RC (mm)	SRI (index)	Version	Load capacity (kg/tire)								
			Rec.	Alt.							km/h - bar	0.6	0.8	1.0	1.2	1.4	1.6	2.0	2.4
IF 900/50 R 42 CFO	180 D	DW 30 B TW 30 B	881	1955	872	5830	950	STD	70	3345	3855	4440	4950	5530	6040	6770	7280		
									From 65 to 40	3680	4240	4880	5440	6080	6640	7440	8000		
									30	3825	4405	5075	5655	6320	6905	7735	8320		
									20	3970	4575	5270	5875	6565	7170	8035	8640		
									10	4670	5380	6195	6905	7720	8430	9445	10160		
									up to 30 Cyc	4780	5510	6340	7070	7900	8630	9670	10400		
									up to 15 Cyc	5700	6570	7560	8430	9420	10290	11530	12400		
									up to 10 Cyc	6255	7205	8295	9245	10335	11285	12645	13600		
									10HT	3825	4405	5075	5655	6320	6905	7735	8320		
									IF 900/60 R 42 CFO	186 D	DW 30 B TW 30 B	916	2147	950	6416	1025	STD	70	3975
From 65 to 40	4370	5035	5795	6460	7220	7885	8835	9500											
30	4540	5235	6025	6715	7505	8200	9185	9880											
20	4715	5435	6255	6975	7795	8515	9540	10260											
10	5545	6390	7355	8200	9165	10010	11220	12065											
up to 30 Cyc	5680	6545	7530	8395	9385	10250	11485	12350											
up to 15 Cyc	6770	7800	8980	10010	11190	12220	13690	14725											
up to 10 Cyc	7425	8555	9850	10980	12270	13400	15015	16150											
10HT	4540	5235	6025	6715	7505	8200	9185	9880											
Ø 46"	IF 750/75 R 46 CFO	186 D	DW 25 B	-	742	2294	1032	6802										1100	STD
									From 65 to 40	4465	5130	5890	6650	7410	8170	8930	9500		
									30	4640	5335	6125	6915	7705	8495	9285	9880		
									20	4820	5540	6360	7180	8000	8820	9640	10260		
									10	5670	6515	7480	8445	9410	10370	11340	12065		
									up to 30 Cyc	5800	6665	7655	8645	9630	10620	11605	12350		
									up to 15 Cyc	6920	7950	9125	10305	11485	12660	13840	14725		
									up to 10 Cyc	7590	8720	10010	11305	12595	13885	15180	16150		
									10HT	4640	5335	6125	6915	7705	8495	9285	9880		
									Ø 50"	IF 480/95 R 50	170 D	DW 16 B	-	479	2170	1002	6574		
From 65 to 40	2820	3240	3720	4200	4680	5160	5640	6000											
30	2930	3365	3865	4365	4865	5365	5865	6240											
20	3045	3495	4015	4535	5050	5570	6090	6480											
10	3580	4110	4720	5330	5940	6550	7160	7620											
up to 10 Cyc with front loader*	3945	4535	5205	5880	6550	7220	7895	8400											
10 HT	2930	3365	3865	4365	4865	5365	5865	6240											

STD: Standard

*For up to 10 Cyc with front loader application inflation pressure to be increased by 0.8 bar.

Technologies



High Speed



IF Technology



Reinforced Bead

Performance



Fuel Economy



Handling and Comfort



High Load Capacity



Reduced Soil Compaction



Self-Cleaning



Traction





TRACTOR

Radial



AGRIMAX SIRIO (R-1W)

AGRIMAX SIRIO is a high-speed tire (up to 70 km/h - 45 mph) developed by BKT for high-performance tractors. Its design is perfect for both haulage and soil tillage applications. The high sidewall flexibility ensures outstanding stability, handling and comfort to improve the driving experience. It is also available with IF technology that allows to carry heavy loads at a low inflating pressure. The reinforced casing and the high number of belts guarantee great traction on the field whereas the low rolling resistance contributes to better fuel economy.

AGRIMAX SIRIO
FAST SPEED RADIAL TIRES

Ø 30"	Tire size	LI/SS	RIM		S.W. (mm)	O.D. (mm)	SLR (mm)	RC (mm)	SRI (index)	Version	Load capacity (kg/tire)								
			Rec.	Alt.							km/h - bar	0.6	0.8	1.0	1.2	1.4	1.6	2.0	2.4
											70	65	50	40	25	10	70	65	50
540/65 R 30	150 D/ 147 E	W 16 L W 18	530	1464	669	4400	700	HS	70	1450	1665	1910	2155	2400	2645	2860	3075		
									65	1575	1810	2080	2345	2615	2885	3120	3350		
IF 600/70 R 30	165 D/ 162 E	DW 21 B DW 20 B	603	1602	713	4759	750	HS	70	2200	2525	2900	3280	3650	4025	4350	4685		
									From 65 to 40	2420	2780	3190	3605	4015	4425	4785	5150		
540/65 R 34	152 D/ 149 E	W 16 L W 18	530	1566	721	4735	750	HS	70	1530	1755	2015	2275	2535	2795	3025	3250		
									65	1670	1920	2205	2485	2770	3055	3305	3550		
540/65 R 38	153 D/ 150 E	W 16 L W 18 L	530	1667	769	5050	800	HS	70	1575	1810	2080	2345	2615	2885	3120	3350		
									65	1720	1975	2265	2555	2850	3140	3395	3650		
710/70 R 38	171 D/ 168 E	DW 23 B DW 25 B	716	1959	887	5840	925	HS	70	2635	3025	3475	3920	4370	4820	5210	5600		
									65	2895	3325	3815	4305	4800	5290	5720	6150		

HS: High Speed

Technologies



Performance





TRACTOR

Radial



AGRIMAX FORTIS (R-1W)

AGRIMAX FORTIS is your reliable partner for all preparation, soil tillage and haulage operations. Designed to equip the latest, most modern and most powerful tractors, AGRIMAX FORTIS allows you to carry very high loads reaching up to 65 km/h. It ensures outstanding traction along with top handling and best comfort for a perfect driving experience. The tire has been designed with a reinforced nylon casing for enhanced productivity in the fields preserving the soil thanks to reduced compaction.

AGRIMAX FORTIS
RADIAL EXTRA LARGE TIRES

Ø 30"	Tire size	LI/SS	RIM		S.W. (mm)	O.D. (mm)	SLR (mm)	RC (mm)	SRI (index)	Version	Load capacity (kg/tire)								
			Rec.	Alt.							km/h - bar	0.6	0.8	1.0	1.2	1.4	1.6	2.0	2.4
											65	50	40	30	10 LT	10 HT	65	50	40
600/70 R 30	158 D/ 161 A8	DW 20 B	DW 18 L ; W 18 L	611	1602	724	4810	750	STD	km/h - bar	0.6	0.8	1.0	1.2	1.4	1.6	2.0	2.4	
										65	2040	2380	2680	2975	3275	3530	3910	4250	
										50	2145	2505	2815	3130	3440	3710	4110	4465	
										40	2220	2590	2915	3240	3565	3840	4255	4625	
										30	2350	2740	3085	3425	3770	4060	4500	4890	
	10 LT	2735	3190	3590	3990	4390	4730	5240	5695										
	10 HT	2350	2740	3085	3425	3770	4060	4500	4890										
	600/70 R 30	158 D/ 161 A8	DW 20 B	DW 18 L ; W 18 L	611	1602	724	4810	750	SPL	km/h - bar	0.6	0.8	1.0	1.2	1.4	1.6	2.0	2.4
											65	2040	2380	2680	2975	3275	3530	3910	4250
											50	2145	2505	2815	3130	3440	3710	4110	4465
40											2220	2590	2915	3240	3565	3840	4255	4625	
30											2350	2740	3085	3425	3770	4060	4500	4890	
10 LT	2735	3190	3590	3990	4390	4730	5240	5695											
10 HT	2350	2740	3085	3425	3770	4060	4500	4890											
Ø 34"	600/70 R 34	160 D/ 163 A8	DW 18 L	DW 20 B ; W 18 L	591	1704	761	5109	800	STD	km/h - bar	0.6	0.8	1.0	1.2	1.4	1.6	2.0	2.4
											65	2160	2520	2835	3150	3465	3735	4140	4500
											50	2270	2650	2980	3310	3640	3925	4350	4725
											40	2340	2730	3075	3415	3755	4050	4485	4875
											30	2485	2900	3265	3625	3985	4300	4765	5175
	10 LT	2895	3380	3800	4225	4645	5005	5550	6030										
	10 HT	2485	2900	3265	3625	3985	4300	4765	5175										
	600/70 R 34	160 D/ 163 A8	DW 18 L	DW 20 B ; W 18 L	591	1704	761	5109	800	SPL	km/h - bar	0.6	0.8	1.0	1.2	1.4	1.6	2.0	2.4
											65	2160	2520	2835	3150	3465	3735	4140	4500
											50	2270	2650	2980	3310	3640	3925	4350	4725
40											2340	2730	3075	3415	3755	4050	4485	4875	
30											2485	2900	3265	3625	3985	4300	4765	5175	
10 LT	2895	3380	3800	4225	4645	5005	5550	6030											
10 HT	2485	2900	3265	3625	3985	4300	4765	5175											
Ø 38"	650/85 R 38	173 D/ 176 A8	DW 23 B	DW 21 B ; DW 20 B	675	2071	935	6184	975	STD	km/h - bar	0.6	0.8	1.0	1.2	1.4	1.6	2.0	2.4
											65	3120	3640	4095	4550	5005	5395	5980	6500
											50	3280	3825	4300	4780	5260	5665	6280	6825
											40	3410	3980	4475	4970	5470	5895	6535	7100
											30	3590	4190	4710	5235	5760	6205	6880	7475
	10 LT	4185	4880	5490	6100	6710	7230	8015	8710										
	10 HT	3590	4190	4710	5235	5760	6205	6880	7475										
	650/85 R 38	173 D/ 176 A8	DW 23 B	DW 21 B ; DW 20 B	675	2071	935	6184	975	SPL	km/h - bar	0.6	0.8	1.0	1.2	1.4	1.6	2.0	2.4
											65	3120	3640	4095	4550	5005	5395	5980	6500
											50	3280	3825	4300	4780	5260	5665	6280	6825
											40	3410	3980	4475	4970	5470	5895	6535	7100
											30	3590	4190	4710	5235	5760	6205	6880	7475
	10 LT	4185	4880	5490	6100	6710	7230	8015	8710										
	10 HT	3590	4190	4710	5235	5760	6205	6880	7475										
	800/70 R 38	178 D/ 181 A8	DW 25 B	DW 27 B	798	2085	912	6202	975	STD	km/h - bar	0.6	0.8	1.0	1.2	1.4	1.6	2.0	2.4
65											3600	4200	4725	5250	5775	6225	6900	7500	
50											3780	4410	4965	5515	6065	6540	7245	7875	
40											3960	4620	5200	5775	6355	6850	7590	8250	
30											4140	4830	5435	6040	6645	7160	7935	8625	
10 LT	4825	5630	6335	7035	7740	8345	9250	10050											
10 HT	4140	4830	5435	6040	6645	7160	7935	8625											

Technologies





Performance



STD: Standard - SPL: Special

AGRIMAX FORTIS (R-1W)

Ø 42"	Tire size	LI/SS	RIM		S.W. (mm)	O.D. (mm)	SLR (mm)	RC (mm)	SRI (index)	Version	Load capacity (kg/tire)							
			Rec.	Alt.														
											km/h - bar	0.6	0.8	1.0	1.2	1.4	1.6	2.0
710/75 R 42	175 D/ 172 E	DW 23 B DW 25 B	716	2133	970	6406	1000	STD	70	3025	3530	3970	4410	4855	5230	5800	6300	
									65	3315	3865	4350	4830	5315	5730	6350	6900	
									50	3480	4060	4565	5075	5580	6015	6670	7245	
									40	3630	4235	4765	5295	5825	6275	6960	7560	
									30	3810	4445	5000	5555	6110	6590	7305	7935	
									10 LT	4440	5180	5830	6475	7125	7680	8510	9250	
									10 HT	3810	4445	5000	5555	6110	6590	7305	7935	
									km/h - bar	0.6	0.8	1.0	1.2	1.4	1.6	2.0	2.4	
710/75 R 42	175 D/ 172 E	DW 23 B DW 25 B	716	2133	970	6406	1000	SPL	70	3025	3530	3970	4410	4855	5230	5800	6300	
									65	3315	3865	4350	4830	5315	5730	6350	6900	
									50	3480	4060	4565	5075	5580	6015	6670	7245	
									40	3630	4235	4765	5295	5825	6275	6960	7560	
									30	3810	4445	5000	5555	6110	6590	7305	7935	
									10 LT	4440	5180	5830	6475	7125	7680	8510	9250	
									10 HT	3810	4445	5000	5555	6110	6590	7305	7935	
									km/h - bar	0.6	0.8	1.0	1.2	1.4	1.6	2.0	2.4	

STD: Standard - SPL: Special

Technologies



Performance





TRACTOR

Radial



AGRIMAX RT 657 (R-1W)

AGRIMAX RT 657 is the ideal tire for on-the-road usage and soil tillage; some sizes are also suitable for vineyard harvesting. This tire guarantees excellent driving comfort as well as significant fuel savings. It has a high load capacity also at high speed levels. AGRIMAX RT 657 is the best choice for those who need a versatile and reliable tire, with no compromise on performance.

Ø 16"	Tire size	LI/SS	RIM		S.W. (mm)	O.D. (mm)	SLR (mm)	RC (mm)	SRI (index)	Version	Load capacity (kg/tire)									
			Rec.	Alt.							km/h - bar	0.6	0.8	1.0	1.2	1.4	1.6	2.0	2.4	
320/65 R 16	117 D/ 120 A8	W 10	W 9 ; W 11	319	822	366	2466	390	STD	km/h - bar	0.6	0.8	1.0	1.2	1.4	1.6	2.0	2.4		
										50	605	710	810	900	990	1070	1185	1285		
										40	635	745	855	945	1040	1125	1245	1350		
										30	660	770	885	980	1080	1165	1290	1400		
										10 LT	700	815	935	1040	1140	1230	1365	1480		
										10 HT	815	950	1090	1210	1330	1435	1590	1725		
10 HT	700	815	935	1040	1140	1230	1365	1480												
Ø 18"	320/65 R 18	109 A8/B	W 10	W 9 ; W 11	319	873	392	2587	410	STD	km/h - bar	0.6	0.8	1.0	1.2	1.4	1.6			
											50	600	695	785	870	950	1030			
											40	600	695	785	870	950	1030			
											30	645	745	840	930	1020	1105			
											10 LT	805	930	1055	1165	1275	1385			
											10 HT	645	745	840	930	1020	1105			
320/65 R 18	125 A8/B	W 10	W 9 ; W 11	310	885	400	2667	410	STD	km/h - bar	0.6	0.8	1.0	1.2	1.4	1.6	1.8	2.0	2.8	3.2
										50	545	645	745	825	925	1010	1205	1340	1505	1650
										40	545	645	745	825	925	1010	1205	1340	1505	1650
										30	585	695	800	885	995	1080	1295	1435	1615	1770
										10 LT	735	865	1000	1110	1245	1355	1620	1795	2020	2215
										10 HT	585	695	800	885	995	1080	1295	1435	1615	1770
340/65 R 18	113 A8/B	W 11	W 10 ; W 12	343	899	400	2667	425	STD	km/h - bar	0.6	0.8	1.0	1.2	1.4	1.6				
										50	645	760	865	970	1060	1150				
										40	645	760	865	970	1060	1150				
										30	695	820	930	1040	1140	1235				
										10 LT	870	1020	1160	1300	1425	1545				
										10 HT	695	820	930	1040	1140	1235				
Ø 20"	340/65 R 20	124 D/ 127 A8	W 11	W 10 ; W 12	343	950	430	2892	450	STD	km/h - bar	0.6	0.8	1.0	1.2	1.4	1.6	2.0	2.4	
											65	755	880	1010	1120	1235	1330	1475	1600	
											50	790	925	1060	1180	1295	1395	1550	1680	
											40	825	965	1105	1225	1350	1455	1610	1750	
											30	865	1015	1160	1290	1420	1530	1695	1840	
											10 LT	1010	1180	1355	1505	1655	1785	1975	2145	
10 HT	865	1015	1160	1290	1420	1530	1695	1840												
420/65 R 20	135 D/ 138 A8	W 13	W 11 ; W 12	418	1054	468	3162	500	STD	km/h - bar	0.6	0.8	1.0	1.2	1.4	1.6	2.0	2.4		
										65	1025	1200	1375	1530	1680	1810	2010	2180		
										50	1080	1260	1445	1605	1765	1905	2110	2290		
										40	1110	1300	1490	1655	1820	1960	2175	2360		
										30	1180	1385	1585	1760	1935	2085	2310	2510		
										10 LT	1375	1610	1845	2050	2255	2430	2695	2925		
10 HT	1180	1385	1585	1760	1935	2085	2310	2510												
440/65 R 20	138 D/ 141 A8	W 14 L	W 13 ; W 15 L	441	1080	479	3240	525	STD	km/h - bar	0.6	0.8	1.0	1.2	1.4	1.6	2.0	2.4		
										65	1110	1300	1490	1655	1820	1960	2175	2360		
										50	1170	1365	1565	1740	1910	2060	2285	2480		
										40	1215	1420	1625	1805	1985	2140	2370	2575		
										30	1280	1495	1715	1905	2095	2255	2500	2715		
										10 LT	1490	1745	1995	2220	2440	2630	2915	3165		
10 HT	1280	1495	1715	1905	2095	2255	2500	2715												

STD: Standard

Technologies



High Speed

Performance



Handling and Comfort



High Load Capacity



Reduced Soil Compaction



Self-Cleaning



Traction





TRACTOR

AGRIMAX RT 657 (R-1W)

Ø 24"	Tire size	LI/SS	RIM		S.W. (mm)	O.D. (mm)	SLR (mm)	RC (mm)	SRI (index)	Version	Load capacity (kg/tire)								
			Rec.	Alt.							km/h - bar	0.6	0.8	1.0	1.2	1.4	1.6	2.0	2.4
420/65 R 24	138 D/ 141 A8	W 13	W 11 ; W 12	418	1156	519	3468	550	STD	65	1110	1300	1490	1655	1820	1960	2175	2360	
										50	1170	1365	1565	1740	1910	2060	2285	2480	
										40	1215	1420	1625	1805	1985	2140	2370	2575	
										30	1280	1495	1715	1905	2095	2255	2500	2715	
										10 LT	1490	1745	1995	2220	2440	2630	2915	3165	
										10 HT	1280	1495	1715	1905	2095	2255	2500	2715	
										km/h - bar	0.6	0.8	1.0	1.2	1.4	1.6	2.0	2.4	
440/65 R 24	135 D/ 138 A8	W 14 L	W 13 ; W 15 L	441	1182	538	3546	575	STD	65	1050	1225	1375	1530	1680	1810	2010	2180	
										50	1100	1285	1445	1605	1765	1905	2110	2290	
										40	1135	1325	1490	1655	1820	1960	2175	2360	
										30	1205	1410	1585	1760	1935	2085	2310	2510	
										10 LT	1405	1640	1845	2050	2255	2430	2695	2925	
										10 HT	1205	1410	1585	1760	1935	2085	2310	2510	
										km/h - bar	0.6	0.8	1.0	1.2	1.4	1.6	2.0	2.4	
440/65 R 24	135 D/ 138 A8	W 14 L	W 13 ; W 15 L	441	1182	538	3546	575	SPL	65	1050	1225	1375	1530	1680	1810	2010	2180	
										50	1100	1285	1445	1605	1765	1905	2110	2290	
										40	1135	1325	1490	1655	1820	1960	2175	2360	
										30	1205	1410	1585	1760	1935	2085	2310	2510	
										10 LT	1405	1640	1845	2050	2255	2430	2695	2925	
										10 HT	1205	1410	1585	1760	1935	2085	2310	2510	
										km/h - bar	0.6	0.8	1.0	1.2	1.4	1.6	2.0	2.4	
480/65 R 24	140 D/ 143 A8	W 15 L	W 14 L	479	1234	562	3730	600	STD	65	1200	1400	1575	1750	1925	2075	2300	2500	
										50	1260	1470	1655	1840	2025	2180	2415	2625	
										40	1310	1530	1720	1910	2100	2265	2510	2725	
										30	1380	1610	1815	2015	2215	2390	2645	2875	
										10 LT	1610	1880	2115	2345	2580	2785	3085	3350	
										10 HT	1380	1610	1815	2015	2215	2390	2645	2875	
										km/h - bar	0.6	0.8	1.0	1.2	1.4	1.6	2.0	2.4	
480/65 R 24	140 D/ 143 A8	W 15 L	W 14 L	479	1234	562	3730	600	SPL	65	1200	1400	1575	1750	1925	2075	2300	2500	
										50	1260	1470	1655	1840	2025	2180	2415	2625	
										40	1310	1530	1720	1910	2100	2265	2510	2725	
										30	1380	1610	1815	2015	2215	2390	2645	2875	
										10 LT	1610	1880	2115	2345	2580	2785	3085	3350	
										10 HT	1380	1610	1815	2015	2215	2390	2645	2875	
										km/h - bar	0.6	0.8	1.0	1.2	1.4	1.6	2.0	2.4	
540/65 R 24	146 D/ 149 A8	W 16 L	W 18 L	530	1312	590	3930	625	STD	65	1440	1680	1890	2100	2310	2490	2760	3000	
										50	1515	1765	1985	2205	2430	2615	2900	3150	
										40	1560	1820	2050	2275	2505	2700	2990	3250	
										30	1660	1935	2175	2415	2660	2865	3175	3450	
										10 LT	1930	2255	2535	2815	3100	3340	3700	4020	
										10 HT	1660	1935	2175	2415	2660	2865	3175	3450	
										km/h - bar	0.6	0.8	1.0	1.2	1.4	1.6	2.0	2.4	
540/65 R 24	146 D/ 149 A8	W 16 L	W 18 L	530	1312	590	3930	625	SPL	65	1440	1680	1890	2100	2310	2490	2760	3000	
										50	1515	1765	1985	2205	2430	2615	2900	3150	
										40	1560	1820	2050	2275	2505	2700	2990	3250	
										30	1660	1935	2175	2415	2660	2865	3175	3450	
										10 LT	1930	2255	2535	2815	3100	3340	3700	4020	
										10 HT	1660	1935	2175	2415	2660	2865	3175	3450	
										km/h - bar	0.6	0.8	1.0	1.2	1.4	1.6	2.0	2.4	
Ø 28"	420/65 R 28	135 D/ 138 A8	W 13	W 12 ; W 11	418	1257	584	3824	600	STD	65	1025	1180	1355	1530	1705	1875	2030	2180
											50	1080	1240	1420	1605	1790	1970	2130	2290
											40	1110	1275	1465	1655	1845	2030	2195	2360
											30	1180	1360	1560	1760	1960	2160	2335	2510
											10 LT	1375	1580	1815	2050	2285	2520	2725	2925
											10 HT	1180	1360	1560	1760	1960	2160	2335	2510
											km/h - bar	0.6	0.8	1.0	1.2	1.4	1.6	2.0	2.4

Technologies



Performance



STD: Standard - SPL: Special

Ø 28"	Tire size	LI/SS	RIM		S.W. (mm)	O.D. (mm)	SLR (mm)	RC (mm)	SRI (index)	Version	Load capacity (kg/tire)								
			Rec.	Alt.							km/h - bar	0.6	0.8	1.0	1.2	1.4	1.6	2.0	2.4
440/65 R 28	138 D/ 141 A8	W 14 L W 13 ; W 15 L	441	1283	590	3927	625	STD	65	1135	1325	1490	1655	1820	1960	2175	2360		
									50	1195	1390	1565	1740	1910	2060	2285	2480		
									40	1240	1445	1625	1805	1985	2140	2370	2575		
									30	1305	1525	1715	1905	2095	2255	2500	2715		
									10 LT	1520	1775	1995	2220	2440	2630	2915	3165		
									10 HT	1305	1525	1715	1905	2095	2255	2500	2715		
									km/h - bar	0.6	0.8	1.0	1.2	1.4	1.6	2.0	2.4		
480/65 R 28	142 D/ 145 A8	W 15 L W 14 L	479	1335	610	4091	650	STD	65	1275	1485	1670	1855	2045	2200	2440	2650		
									50	1340	1560	1755	1950	2145	2315	2565	2785		
									40	1395	1625	1830	2030	2235	2410	2670	2900		
									30	1465	1710	1925	2135	2350	2535	2810	3050		
									10 LT	1710	1995	2240	2490	2740	2955	3275	3555		
									10 HT	1465	1710	1925	2135	2350	2535	2810	3050		
									km/h - bar	0.6	0.8	1.0	1.2	1.4	1.6	2.0	2.4		
540/65 R 28	149 D/ 152 A8	W 16 L W 18 L	530	1413	643	4253	675	STD	65	1560	1820	2050	2275	2505	2700	2990	3250		
									50	1640	1915	2155	2395	2630	2835	3145	3415		
									40	1705	1990	2240	2485	2735	2950	3270	3550		
									30	1800	2095	2360	2620	2880	3105	3445	3740		
									10 LT	2095	2440	2745	3050	3355	3615	4010	4355		
									10 HT	1800	2095	2360	2620	2880	3105	3445	3740		
									km/h - bar	0.6	0.8	1.0	1.2	1.4	1.6	2.0	2.4		
540/65 R 28	149 D/ 152 A8	W 16 L W 18 L	530	1413	643	4253	675	SPL	65	1560	1820	2050	2275	2505	2700	2990	3250		
									50	1640	1915	2155	2395	2630	2835	3145	3415		
									40	1705	1990	2240	2485	2735	2950	3270	3550		
									30	1800	2095	2360	2620	2880	3105	3445	3740		
									10 LT	2095	2440	2745	3050	3355	3615	4010	4355		
									10 HT	1800	2095	2360	2620	2880	3105	3445	3740		
									km/h - bar	0.6	0.8	1.0	1.2	1.4	1.6	2.0	2.4		
600/65 R 28	154 D/ 157 A8	DW 20 B W 18 L	611	1491	670	4470	700	STD	65	1800	2100	2365	2625	2890	3115	3450	3750		
									50	1895	2210	2485	2760	3035	3275	3625	3940		
									40	1980	2310	2600	2890	3180	3425	3795	4125		
									30	2075	2420	2720	3025	3325	3585	3970	4315		
									10 LT	2415	2815	3170	3520	3870	4175	4625	5025		
									10 HT	2075	2420	2720	3025	3325	3585	3970	4315		
									km/h - bar	0.6	0.8	1.0	1.2	1.4	1.6	2.0	2.4		
600/65 R 28	154 D/ 157 A8	DW 20 B W 18 L	611	1491	670	4470	700	SPL	65	1800	2100	2365	2625	2890	3115	3450	3750		
									50	1895	2210	2485	2760	3035	3275	3625	3940		
									40	1980	2310	2600	2890	3180	3425	3795	4125		
									30	2075	2420	2720	3025	3325	3585	3970	4315		
									10 LT	2415	2815	3170	3520	3870	4175	4625	5025		
									10 HT	2075	2420	2720	3025	3325	3585	3970	4315		
									km/h - bar	0.6	0.8	1.0	1.2	1.4	1.6	2.0	2.4		
Ø 30"	420/65 R 30	136 D/ 139 A8	W 13 W 12 ; W 11	418	1308	606	3952	625	STD	65	1055	1210	1390	1570	1750	1930	2085	2240	
										50	1110	1275	1465	1650	1840	2030	2195	2355	
										40	1145	1315	1510	1705	1900	2090	2260	2430	
										30	1215	1395	1600	1810	2015	2220	2400	2580	
										10 LT	1415	1625	1865	2105	2345	2585	2795	3005	
										10 HT	1215	1395	1600	1810	2015	2220	2400	2580	
										km/h - bar	0.6	0.8	1.0	1.2	1.4	1.6	2.0	2.4	
540/65 R 30	150 D/ 153 A8	W 16 L W 18 L	530	1464	670	4403	700	STD	65	1610	1880	2115	2345	2580	2785	3085	3350		
									50	1690	1975	2220	2465	2715	2925	3240	3520		
									40	1755	2045	2300	2555	2815	3030	3360	3650		
									30	1855	2160	2430	2700	2970	3200	3550	3855		
									10 LT	2160	2515	2830	3145	3460	3730	4135	4490		
									10 HT	1855	2160	2430	2700	2970	3200	3550	3855		
									km/h - bar	0.6	0.8	1.0	1.2	1.4	1.6	2.0	2.4		

Technologies



High Speed

Performance



Handling and Comfort



High Load Capacity



Reduced Soil Compaction



Self-Cleaning



Traction

STD: Standard - SPL: Special



TRACTOR

AGRIMAX RT 657 (R-1W)

Ø 30"	Tire size	LI/SS	RIM		S.W. (mm)	O.D. (mm)	SLR (mm)	RC (mm)	SRI (index)	Version	Load capacity (kg/tire)								
			Rec.	Alt.							km/h - bar	0.6	0.8	1.0	1.2	1.4	1.6	2.0	2.4
540/65 R 30	150 D/153 A8	W 16 L	W 18 L	530	1464	670	4403	700	SPL	65	1610	1880	2115	2345	2580	2785	3085	3350	
										50	1690	1975	2220	2465	2715	2925	3240	3520	
										40	1755	2045	2300	2555	2815	3030	3360	3650	
										30	1855	2160	2430	2700	2970	3200	3550	3855	
										10 LT	2160	2515	2830	3145	3460	3730	4135	4490	
										10 HT	1855	2160	2430	2700	2970	3200	3550	3855	
600/65 R 30	155 D/158 A8	DW 20 B	W 18 L	611	1542	697	4609	725	STD	km/h - bar	0.6	0.8	1.0	1.2	1.4	1.6	2.0	2.4	
										65	1860	2170	2445	2715	2985	3220	3565	3875	
										50	1955	2280	2565	2850	3135	3380	3745	4070	
										40	2040	2380	2680	2975	3275	3530	3910	4250	
										30	2145	2500	2810	3125	3435	3705	4105	4460	
										10 LT	2495	2910	3275	3640	4005	4315	4780	5195	
10 HT	2145	2500	2810	3125	3435	3705	4105	4460											
Ø 34"	540/65 R 34	152 D/155 A8	W 16 L	W 18 L	530	1566	712	4742	750	STD	km/h - bar	0.6	0.8	1.0	1.2	1.4	1.6	2.0	2.4
											65	1705	1990	2240	2485	2735	2950	3270	3550
											50	1795	2090	2350	2615	2875	3100	3435	3730
											40	1860	2170	2445	2715	2985	3220	3565	3875
											30	1965	2290	2575	2860	3150	3395	3760	4085
											10 LT	2285	2670	3000	3335	3670	3955	4380	4760
10 HT	1965	2290	2575	2860	3150	3395	3760	4085											
540/65 R 34	152 D/155 A8	W 16 L	W 18 L	530	1566	712	4742	750	SPL	km/h - bar	0.6	0.8	1.0	1.2	1.4	1.6	2.0	2.4	
										65	1705	1990	2240	2485	2735	2950	3270	3550	
										50	1795	2090	2350	2615	2875	3100	3435	3730	
										40	1860	2170	2445	2715	2985	3220	3565	3875	
										30	1965	2290	2575	2860	3150	3395	3760	4085	
										10 LT	2285	2670	3000	3335	3670	3955	4380	4760	
10 HT	1965	2290	2575	2860	3150	3395	3760	4085											
600/65 R 34	157 D/160 A8	DW 20 B	W 18 L	611	1644	742	4960	775	STD	km/h - bar	0.6	0.8	1.0	1.2	1.4	1.6	2.0	2.4	
										65	1980	2310	2600	2890	3180	3425	3795	4125	
										50	2085	2430	2735	3035	3340	3600	3990	4335	
										40	2160	2520	2835	3150	3465	3735	4140	4500	
										30	2280	2660	2990	3325	3655	3940	4370	4745	
										10 LT	2655	3100	3485	3875	4260	4590	5090	5530	
10 HT	2280	2660	2990	3325	3655	3940	4370	4745											
600/65 R 34	157 D/160 A8	DW 20 B	W 18 L	611	1644	742	4960	775	SPL	km/h - bar	0.6	0.8	1.0	1.2	1.4	1.6	2.0	2.4	
										65	1980	2310	2600	2890	3180	3425	3795	4125	
										50	2085	2430	2735	3035	3340	3600	3990	4335	
										40	2160	2520	2835	3150	3465	3735	4140	4500	
										30	2280	2660	2990	3325	3655	3940	4370	4745	
										10 LT	2655	3100	3485	3875	4260	4590	5090	5530	
10 HT	2280	2660	2990	3325	3655	3940	4370	4745											
Ø 38"	540/65 R 38	153 D/156 A8	W 16 L	W 18 L	530	1667	760	5059	800	STD	km/h - bar	0.6	0.8	1.0	1.2	1.4	1.6	2.0	2.4
											65	1755	2045	2300	2555	2815	3030	3360	3650
											50	1845	2150	2420	2685	2955	3185	3530	3835
											40	1920	2240	2520	2800	3080	3320	3680	4000
											30	2020	2355	2650	2940	3235	3490	3865	4200
											10 LT	2350	2745	3085	3430	3770	4065	4505	4895
10 HT	2020	2355	2650	2940	3235	3490	3865	4200											
540/65 R 38	153 D/156 A8	W 16 L	W 18 L	530	1667	760	5059	800	SPL	km/h - bar	0.6	0.8	1.0	1.2	1.4	1.6	2.0	2.4	
										65	1755	2045	2300	2555	2815	3030	3360	3650	
										50	1845	2150	2420	2685	2955	3185	3530	3835	
										40	1920	2240	2520	2800	3080	3320	3680	4000	
										30	2020	2355	2650	2940	3235	3490	3865	4200	
										10 LT	2350	2745	3085	3430	3770	4065	4505	4895	
10 HT	2020	2355	2650	2940	3235	3490	3865	4200											

Technologies



High Speed

Performance



Handling and Comfort



High Load Capacity



Reduced Soil Compaction



Self-Cleaning



Traction

STD: Standard - SPL: Special



TRACTOR

AGRIMAX RT 657 (R-1W)

Ø 38"	Tire size	LI/SS	RIM		S.W. (mm)	O.D. (mm)	SLR (mm)	RC (mm)	SRI (index)	Version	Load capacity (kg/tire)								
			Rec.	Alt.							km/h - bar	0.6	0.8	1.0	1.2	1.4	1.6	2.0	2.4
600/65 R 38	159 D/ 162 A8	DW 20 B	W 18 L	611	1745	790	5247	825	STD	65	2100	2450	2760	3065	3370	3635	4025	4375	
										50	2210	2575	2895	3220	3540	3815	4230	4595	
										40	2280	2660	2995	3325	3660	3945	4370	4750	
										30	2420	2820	3175	3525	3880	4180	4635	5035	
										10 LT	2820	3285	3695	4110	4520	4870	5400	5865	
										10 HT	2420	2820	3175	3525	3880	4180	4635	5035	
										km/h - bar	0.6	0.8	1.0	1.2	1.4	1.6	2.0	2.4	
600/65 R 38	159 D/ 162 A8	DW 20 B	W 18 L	611	1745	790	5247	825	SPL	65	2100	2450	2760	3065	3370	3635	4025	4375	
										50	2210	2575	2895	3220	3540	3815	4230	4595	
										40	2280	2660	2995	3325	3660	3945	4370	4750	
										30	2420	2820	3175	3525	3880	4180	4635	5035	
										10 LT	2820	3285	3695	4110	4520	4870	5400	5865	
										10 HT	2420	2820	3175	3525	3880	4180	4635	5035	
										km/h - bar	0.6	0.8	1.0	1.2	1.4	1.6	2.0	2.4	
650/65 R 38	163 D/ 166 A8	DW 20 B	DW 21 B ; DW 23 B	645	1811	830	5483	875	STD	65	2340	2730	3075	3415	3755	4050	4485	4875	
										50	2460	2870	3230	3585	3945	4250	4715	5120	
										40	2545	2970	3340	3710	4085	4400	4880	5300	
										30	2695	3145	3535	3930	4320	4660	5165	5610	
										10 LT	3140	3660	4120	4575	5035	5425	6015	6535	
										10 HT	2695	3145	3535	3930	4320	4660	5165	5610	
										km/h - bar	0.6	0.8	1.0	1.2	1.4	1.6	2.0	2.4	
650/65 R 38	178 A8/ 175 B	DW 20 B	DW 21 B ; DW 23 B	645	1816	827	5488	875	STD	km/h - bar	3.5								
										50	6900								
										40	7500								
										30	8030								
										25	8330								
										10	11250								
										Static	17250								
										10 LT	10500								
										20 LT	9000								
										10 HT	8030								
900/55 R 38	179 D/ 181 A8	DW 27 B	DW 30 B	880	1950	880	5842	925	STD	65	3255	3800	4265	4805	5350	5890	6590	7055	7750
										50	3420	3990	4480	5050	5620	6190	6920	7410	8140
										40	3465	4045	4540	5115	5695	6270	7015	7510	8250
										30	3745	4370	4905	5530	6155	6780	7580	8115	8915
										10 LT	4365	5090	5715	6440	7170	7895	8830	9455	10385
										10 HT	3745	4370	4905	5530	6155	6780	7580	8115	8915
										km/h - bar	0.6	0.8	1.0	1.2	1.4	1.6	2.0	2.4	2.8
Ø 42"	650/65 R 42	165 D/ 168 A8	DW 20 B	DW 21 B ; DW 23 B	645	1913	878	5810	925	STD	65	2475	2885	3245	3605	3970	4275	4740	5150
											50	2600	3030	3410	3790	4170	4495	4980	5410
											40	2690	3140	3530	3920	4315	4650	5155	5600
											30	2845	3320	3735	4150	4565	4920	5455	5925
											10 LT	3315	3870	4355	4835	5320	5735	6355	6905
											10 HT	2845	3320	3735	4150	4565	4920	5455	5925
											km/h - bar	0.6	0.8	1.0	1.2	1.4	1.6	2.0	2.4

Technologies



High Speed

Performance



Handling and Comfort



High Load Capacity



Reduced Soil Compaction



Self-Cleaning



Traction

STD: Standard - SPL: Special





TRACTOR

Radial



AGRIMAX RT 765 (R-1W)

AGRIMAX RT 765, a BKT 70 series tire, is suitable for cutting-edge tractors for several heavy-duty applications such as soil tillage, field and road transport, vineyard harvesting, and spraying. A wide contact patch ensures the best possible traction and comfort on all surfaces at any time. This tire provides great self-cleaning properties and reduced soil compaction. Two sizes are available with steel-belted technology.

Ø 16"	Tire size	LI/SS	RIM		S.W. (mm)	O.D. (mm)	SLR (mm)	RC (mm)	SRI (index)	Version	Load capacity (kg/tire)								
			Rec.	Alt.							km/h - bar	0.6	0.8	1.0	1.2	1.4	1.6	2.0	2.4
200/70 R 16	94 A8/B	W 6	-	197	686	315	2060	330	STD	km/h - bar	0.6	0.8	1.0	1.2	1.4	1.6	2.0	2.4	
										50	315	365	420	470	525	580	625	670	
										40	315	365	420	470	525	580	625	670	
										30	340	390	450	505	565	620	670	720	
										10 LT	425	490	560	630	705	775	840	900	
10 HT	340	390	450	505	565	620	670	720											
220/70 R 16	99 A8/B	W 7	W 8	221	715	324	2145	340	STD	km/h - bar	0.6	0.8	1.0	1.2	1.4	1.6	2.0	2.4	
										50	365	420	485	545	605	670	725	775	
										40	365	420	485	545	605	670	725	775	
										30	395	450	515	585	650	715	775	830	
										10 LT	490	656	645	730	815	895	970	1040	
10 HT	395	450	515	585	650	715	775	830											
240/70 R 16	104 A8/B	W 8	W 8 L ; W 9 L	244	742	335	2176	350	STD	km/h - bar	0.6	0.8	1.0	1.2	1.4	1.6	2.0	2.4	
										50	425	490	560	630	705	775	840	900	
										40	425	490	560	630	705	775	840	900	
										30	455	525	600	680	755	830	900	965	
										10 LT	570	655	755	850	945	1045	1130	1210	
10 HT	455	525	600	680	755	830	900	965											
260/70 R 16	109 A8/B	W 8	W 8 L ; W 9 L	258	770	346	2283	360	STD	km/h - bar	0.6	0.8	1.0	1.2	1.4	1.6	2.0	2.4	
										50	485	560	640	725	805	890	960	1030	
										40	485	560	640	725	805	890	960	1030	
										30	520	600	690	775	865	955	1030	1105	
										10 LT	650	750	860	970	1080	1190	1285	1380	
10 HT	520	600	690	775	865	955	1030	1105											
280/70 R 16	112 A8/B	W 9	W 8 ; W 8 L ; W 10	282	798	356	2370	390	STD	km/h - bar	0.6	0.8	1.0	1.2	1.4	1.6	2.0	2.4	
										50	530	605	695	785	875	965	1045	1120	
										40	530	605	695	785	875	965	1045	1120	
										30	565	650	745	840	940	1035	1120	1200	
										10 LT	710	815	935	1055	1175	1295	1400	1505	
10 HT	565	650	745	840	940	1035	1120	1200											
Ø 18"	280/70 R 18	114 A8/B	W 9	W 8 ; W 10	282	849	381	2547	410	STD	km/h - bar	0.6	0.8	1.0	1.2	1.4	1.6	2.0	2.4
											50	555	640	735	830	925	1015	1100	1180
											40	555	640	735	830	925	1015	1100	1180
											30	595	685	785	890	990	1090	1180	1265
											10 LT	745	860	985	1110	1240	1365	1475	1585
10 HT	595	685	785	890	990	1090	1180	1265											
Ø 20"	260/70 R 20	113 A8/B	W 8	9 ; W 9	258	872	402	2639	425	STD	km/h - bar	0.6	0.8	1.0	1.2	1.4	1.6	2.0	2.4
											50	545	625	715	805	900	990	1070	1150
											40	545	625	715	805	900	990	1070	1150
											30	585	670	770	865	965	1065	1150	1235
											10 LT	730	835	960	1085	1210	1330	1440	1545
10 HT	585	670	770	865	965	1065	1150	1235											
260/70 R 20	113 A8/B	W 8	9 ; W 9	258	872	402	2639	410	SPL	km/h - bar	0.6	0.8	1.0	1.2	1.4	1.6	2.0	2.4	
										50	545	625	715	805	900	990	1070	1150	
										40	545	625	715	805	900	990	1070	1150	
										30	585	670	770	865	965	1065	1150	1235	
										10 LT	730	835	960	1085	1210	1330	1440	1545	
10 HT	585	670	770	865	965	1065	1150	1235											

Technologies



Performance



STD: Standard - SPL: Special



TRACTOR

AGRIMAX RT 765 (R-1W)

Ø 20"	Tire size	LI/SS	RIM		S.W. (mm)	O.D. (mm)	SLR (mm)	RC (mm)	SRI (index)	Version	Load capacity (kg/tire)							
			Rec.	Alt.														
											km/h - bar	0.6	0.8	1.0	1.2	1.4	1.6	2.0
280/70 R 20	116 A8/B	W 9	W 8 ; W 10	282	900	408	2705	450	STD	50	590	675	775	875	975	1075	1165	1250
										40	590	675	775	875	975	1075	1165	1250
										30	630	725	835	940	1050	1155	1250	1340
										10 LT	790	905	1040	1175	1310	1445	1560	1675
										10 HT	630	725	835	940	1050	1155	1250	1340
280/70 R 20	116 A8/B	W 9	W 8 ; W 10	282	900	408	2705	450	SPL	50	590	675	775	875	975	1075	1165	1250
										40	590	675	775	875	975	1075	1165	1250
										30	630	725	835	940	1050	1155	1250	1340
										10 LT	790	905	1040	1175	1310	1445	1560	1675
										10 HT	630	725	835	940	1050	1155	1250	1340
300/70 R 20	120 A8/B	W 9	W 10	295	952	428	2854	450	STD	50	660	760	870	980	1095	1205	1305	1400
										40	660	760	870	980	1095	1205	1305	1400
										30	705	810	930	1050	1170	1290	1395	1500
										10 LT	885	1020	1170	1320	1470	1620	1750	1880
										10 HT	705	810	930	1050	1170	1290	1395	1500
320/70 R 20	123 A8/B	W 10	W 9 ; W 11	319	982	445	2938	475	STD	50	730	840	965	1085	1210	1335	1445	1550
										40	730	840	965	1085	1210	1335	1445	1550
										30	785	900	1030	1165	1295	1430	1545	1660
										10 LT	980	1125	1290	1460	1625	1790	1935	2080
										10 HT	785	900	1030	1165	1295	1430	1545	1660
360/70 R 20	129 A8/B	W 11	W 10 ; W 12	357	1042	469	3122	500	STD	50	870	1000	1150	1295	1445	1595	1725	1850
										40	870	1000	1150	1295	1445	1595	1725	1850
										30	935	1070	1230	1390	1545	1705	1845	1980
										10 LT	1170	1340	1540	1740	1935	2135	2310	2480
										10 HT	935	1070	1230	1390	1545	1705	1845	1980
380/70 R 20	132 A8/B	W 12	W 11 ; W 13	380	1082	482	3213	525	STD	50	940	1080	1240	1400	1560	1720	1860	2000
										40	940	1080	1240	1400	1560	1720	1860	2000
										30	1010	1160	1330	1500	1670	1845	1995	2140
										10 LT	1260	1450	1665	1880	2095	2305	2495	2680
										10 HT	1010	1160	1330	1500	1670	1845	1995	2140
Ø 24"	320/70 R 24	116 D	W 10	W 9 ; W 11	319	1094	502	3245	525	STD	65	690	800	915	1025	1140	1250	1370
											50	725	845	960	1080	1200	1315	1440
											40	755	880	1005	1125	1250	1370	1500
											30	795	925	1055	1185	1315	1440	1570
											10 LT	925	1075	1225	1375	1525	1675	1825
320/70 R 24	116 D	W 10	W 9 ; W 11	319	1094	502	3245	525	SPL	65	690	800	915	1025	1140	1250	1370	
										50	725	845	960	1080	1200	1315	1440	
										40	755	880	1005	1125	1250	1370	1500	
										30	795	925	1055	1185	1315	1440	1570	
										10 LT	925	1075	1225	1375	1525	1675	1825	
360/70 R 24	122 D	W 11	W 10 ; W 12	357	1152	519	3395	550	STD	65	825	960	1095	1230	1365	1500	1645	
										50	870	1010	1150	1295	1435	1575	1725	
										40	905	1055	1205	1350	1500	1645	1795	
										30	950	1105	1260	1415	1570	1725	1880	
										10 LT	1110	1290	1470	1650	1830	2010	2200	
10 HT	950	1105	1260	1415	1570	1725	1880											

Technologies



Performance



STD: Standard - SPL: Special



TRACTOR

AGRIMAX RT 765 (R-1W)

Ø 24"	Tire size	LI/SS	RIM		S.W. (mm)	O.D. (mm)	SLR (mm)	RC (mm)	SRI (index)	Version	Load capacity (kg/tire)						
			Rec.	Alt.							km/h - bar	0.6	0.8	1.0	1.2	1.4	1.6
360/70 R 24	122 D	W 11	W 10 ; W 12	357	1152	519	3395	550	SPL	km/h - bar	0.6	0.8	1.0	1.2	1.4	1.6	
										65	825	960	1095	1230	1365	1500	
										50	870	1010	1150	1295	1435	1575	
										40	905	1055	1205	1350	1500	1645	
										30	950	1105	1260	1415	1570	1725	
										10 LT	1110	1290	1470	1650	1830	2010	
										10 HT	950	1105	1260	1415	1570	1725	
380/70 R 24	125 D	W 12	W 11 ; W 13	380	1190	538	3560	575	STD	km/h - bar	0.6	0.8	1.0	1.2	1.4	1.6	
										65	910	1060	1205	1355	1505	1650	
										50	955	1115	1270	1425	1580	1735	
										40	1000	1160	1325	1485	1650	1810	
										30	1045	1220	1390	1560	1730	1900	
										10 LT	1220	1420	1620	1820	2020	2215	
										10 HT	1045	1220	1390	1560	1730	1900	
380/70 R 24	125 D	W 12	W 11 ; W 13	380	1190	538	3560	575	SPL	km/h - bar	0.6	0.8	1.0	1.2	1.4	1.6	
										65	910	1060	1205	1355	1505	1650	
										50	955	1115	1270	1425	1580	1735	
										40	1000	1160	1325	1485	1650	1810	
										30	1045	1220	1390	1560	1730	1900	
										10 LT	1220	1420	1620	1820	2020	2215	
										10 HT	1045	1220	1390	1560	1730	1900	
420/70 R 24	130 D	W 13	W 12 ; W 14 L	418	1248	554	3680	600	STD	km/h - bar	0.6	0.8	1.0	1.2	1.4	1.6	
										65	1045	1220	1390	1560	1730	1900	
										50	1100	1280	1460	1640	1820	1995	
										40	1150	1335	1525	1710	1900	2085	
										30	1205	1400	1600	1795	1990	2185	
										10 LT	1405	1635	1865	2095	2325	2550	
										10 HT	1205	1400	1600	1795	1990	2185	
420/70 R 24	134 D	W 13	W 12 ; W 14 L	418	1248	554	3680	600	STD	km/h - bar	0.6	0.8	1.0	1.2	1.4	1.6	2.0
										65	1060	1230	1400	1590	1760	1930	2120
										50	1115	1295	1475	1675	1855	2030	2230
										40	1165	1350	1535	1745	1930	2120	2325
										30	1220	1420	1615	1830	2030	2225	2440
										10 LT	1425	1655	1880	2135	2365	2590	2745
										10 HT	1220	1420	1615	1830	2030	2225	2440
420/70 R 24	134 D	W 13	W 12 ; W 14 L	418	1248	554	3680	600	SPL	km/h - bar	0.6	0.8	1.0	1.2	1.4	1.6	2.0
										65	1060	1230	1400	1590	1760	1930	2120
										50	1115	1295	1475	1675	1855	2030	2230
										40	1165	1350	1535	1745	1930	2120	2325
										30	1220	1420	1615	1830	2030	2225	2440
										10 LT	1425	1655	1880	2135	2365	2590	2845
										10 HT	1220	1420	1615	1830	2030	2225	2440
420/70 R 24	130 D	W 13	W 12 ; W 14 L	418	1248	554	3680	600	SPL	km/h - bar	0.6	0.8	1.0	1.2	1.4	1.6	
										65	1045	1220	1390	1560	1730	1900	
										50	1100	1280	1460	1640	1820	1995	
										40	1150	1335	1525	1710	1900	2085	
										30	1205	1400	1600	1795	1990	2185	
										10 LT	1405	1635	1865	2095	2325	2550	
										10 HT	1205	1400	1600	1795	1990	2185	
480/70 R 24	138 D	W 15 L	W 14 L ; W 16 L	479	1316	580	3894	625	STD	km/h - bar	0.6	0.8	1.0	1.2	1.4	1.6	
										65	1300	1515	1725	1940	2150	2360	
										50	1365	1590	1815	2035	2260	2480	
										40	1425	1655	1890	2120	2355	2585	
										30	1495	1740	1985	2230	2475	2715	
										10 LT	1745	2030	2315	2600	2885	3165	
										10 HT	1495	1740	1985	2230	2475	2715	

STD: Standard - SPL: Special

Technologies



Performance



Ø 24"	Tire size	LI/SS	RIM		S.W. (mm)	O.D. (mm)	SLR (mm)	RC (mm)	SRI (index)	Version	Load capacity (kg/tire)					
			Rec.	Alt.							km/h - bar	0.6	0.8	1.0	1.2	1.4
480/70 R 24	138 D	W 15 L	W 14 L ; W 16 L	479	1316	580	3984	625	SPL	65	1300	1515	1725	1940	2150	2360
										50	1365	1590	1815	2035	2260	2480
										40	1425	1655	1890	2120	2355	2585
										30	1495	1740	1985	2230	2475	2715
										10 LT	1745	2030	2315	2600	2885	3165
										10 HT	1495	1740	1985	2230	2475	2715
										km/h - bar	0.6	0.8	1.0	1.2	1.4	1.6
360/70 R 28	125 D	W 11	W 10 ; W 12	357	1251	579	3767	600	STD	65	910	1060	1205	1355	1505	1650
										50	955	1115	1270	1425	1580	1735
										40	1000	1160	1325	1485	1650	1810
										30	1045	1220	1390	1560	1730	1900
										10 LT	1220	1420	1620	1820	2020	2215
										10 HT	1045	1220	1390	1560	1730	1900
										km/h - bar	0.6	0.8	1.0	1.2	1.4	1.6
360/70 R 28	125 D	W 11	W 10 ; W 12	357	1251	579	3767	600	SPL	65	910	1060	1205	1355	1505	1650
										50	955	1115	1270	1425	1580	1735
										40	1000	1160	1325	1485	1650	1810
										30	1045	1220	1390	1560	1730	1900
										10 LT	1220	1420	1620	1820	2020	2215
										10 HT	1045	1220	1390	1560	1730	1900
										km/h - bar	0.6	0.8	1.0	1.2	1.4	1.6
380/70 R 28	127 D	W 12	W 11 ; W 13	380	1293	586	3883	625	STD	65	965	1120	1280	1435	1595	1750
										50	1015	1180	1345	1510	1675	1840
										40	1060	1230	1405	1575	1750	1920
										30	1110	1290	1475	1655	1835	2015
										10 LT	1290	1505	1715	1925	2135	2345
										10 HT	1110	1290	1475	1655	1835	2015
										km/h - bar	0.6	0.8	1.0	1.2	1.4	1.6
380/70 R 28	127 D	W 12	W 11 ; W 13	380	1293	586	3883	625	SPL	65	965	1120	1280	1435	1595	1750
										50	1015	1180	1345	1510	1675	1840
										40	1060	1230	1405	1575	1750	1920
										30	1110	1290	1475	1655	1835	2015
										10 LT	1290	1505	1715	1925	2135	2345
										10 HT	1110	1290	1475	1655	1835	2015
										km/h - bar	0.6	0.8	1.0	1.2	1.4	1.6
420/70 R 28	133 D	W 13	W 12 ; W 14 L	418	1349	604	4020	650	STD	65	1135	1320	1505	1690	1875	2060
										50	1195	1390	1585	1780	1975	2165
										40	1245	1450	1650	1855	2060	2260
										30	1305	1520	1735	1945	2160	2370
										10 LT	1525	1770	2020	2270	2520	2765
										10 HT	1305	1520	1735	1945	2160	2370
										km/h - bar	0.6	0.8	1.0	1.2	1.4	1.6
420/70 R 28	133 D	W 13	W 12 ; W 14 L	418	1349	604	4020	650	SPL	65	1135	1320	1505	1690	1875	2060
										50	1195	1390	1585	1780	1975	2165
										40	1245	1450	1650	1855	2060	2260
										30	1305	1520	1735	1945	2160	2370
										10 LT	1525	1770	2020	2270	2520	2765
										10 HT	1305	1520	1735	1945	2160	2370
										km/h - bar	0.6	0.8	1.0	1.2	1.4	1.6
480/70 R 28	140 D	W 15 L	W 14 L ; W 16 L	479	1421	634	4185	675	STD	65	1375	1600	1825	2050	2275	2500
										50	1445	1680	1920	2155	2390	2625
										40	1510	1755	2005	2250	2495	2740
										30	1585	1840	2100	2360	2620	2875
										10 LT	1845	2145	2450	2750	3050	3350
										10 HT	1585	1840	2100	2360	2620	2875
										km/h - bar	0.6	0.8	1.0	1.2	1.4	1.6

Technologies



Performance



STD: Standard - SPL: Special



TRACTOR

AGRIMAX RT 765 (R-1W)

Ø 28"	Tire size	LI/SS	RIM		S.W. (mm)	O.D. (mm)	SLR (mm)	RC (mm)	SRI (index)	Version	Load capacity (kg/tire)								
			Rec.	Alt.							km/h - bar	0.6	0.8	1.0	1.2	1.4	1.6		
											65	50	40	30	10 LT	10 HT	65	50	40
Ø 28"	480/70 R 28	140 D	W 15 L	W 14 L ; W 16 L	479	1421	634	4185	675	SPL	km/h - bar	0.6	0.8	1.0	1.2	1.4	1.6		
											65	1375	1600	1825	2050	2275	2500		
											50	1445	1680	1920	2155	2390	2625		
											40	1510	1755	2005	2250	2495	2740		
											30	1585	1840	2100	2360	2620	2875		
											10 LT	1845	2145	2450	2750	3050	3350		
	10 HT	1585	1840	2100	2360	2620	2875												
	600/70 R 28	157 D	DW 18 L	DW 20 B	591	1551	696	4692	725	STD	km/h - bar	0.6	0.8	1.0	1.2	1.4	1.6	2.0	2.4
											65	1940	2230	2560	2890	3220	3550	3880	4125
											50	2040	2345	2690	3035	3385	3730	4075	4335
											40	2125	2445	2805	3165	3530	3890	4250	4520
											30	2235	2565	2945	3325	3705	4085	4465	4745
											10 LT	2600	2990	3430	3875	4315	4760	5200	5530
	10 HT	2235	2565	2945	3325	3705	4085	4465	4745										
	Ø 30"	420/70 R 30	134 D	W 13	W 12 ; W 14 L	418	1398	631	4172	675	STD	km/h - bar	0.6	0.8	1.0	1.2	1.4	1.6	
65												1170	1360	1550	1740	1930	2120		
50												1230	1430	1630	1830	2030	2230		
40												1280	1490	1700	1910	2120	2325		
30												1345	1565	1785	2005	2225	2440		
10 LT												1565	1825	2080	2335	2590	2845		
10 HT		1345	1565	1785	2005	2225	2440												
420/70 R 30		134 D	W 13	W 12 ; W 14 L	418	1398	631	4172	675	SPL	km/h - bar	0.6	0.8	1.0	1.2	1.4	1.6		
											65	1170	1360	1550	1740	1930	2120		
											50	1230	1430	1630	1830	2030	2230		
											40	1280	1490	1700	1910	2120	2325		
											30	1345	1565	1785	2005	2225	2440		
											10 LT	1565	1825	2080	2335	2590	2845		
10 HT		1345	1565	1785	2005	2225	2440												
480/70 R 30		141 D	W 15 L	W 14 L ; W 16 L	479	1478	659	4372	700	STD	km/h - bar	0.6	0.8	1.0	1.2	1.4	1.6		
	65										1420	1650	1880	2115	2345	2575			
	50										1490	1735	1975	2220	2465	2705			
	40										1555	1805	2060	2315	2570	2820			
	30										1635	1900	2165	2435	2700	2965			
	10 LT										1905	2215	2525	2835	3145	3455			
10 HT	1635	1900	2165	2435	2700	2965													
480/70 R 30	141 D	W 15 L	W 14 L ; W 16 L	479	1478	659	4372	700	SPL	km/h - bar	0.6	0.8	1.0	1.2	1.4	1.6			
										65	1420	1650	1880	2115	2345	2575			
										50	1490	1735	1975	2220	2465	2705			
										40	1555	1805	2060	2315	2570	2820			
										30	1635	1900	2165	2435	2700	2965			
										10 LT	1905	2215	2525	2835	3145	3455			
10 HT	1635	1900	2165	2435	2700	2965													
600/70 R 30	152 D	DW 20 B	DW 18 L ; W 18 L	611	1602	711	4774	750	STD	km/h - bar	0.6	0.8	1.0	1.2	1.4	1.6			
										65	1955	2275	2595	2915	3235	3550			
										50	2055	2390	2725	3060	3395	3730			
										40	2140	2490	2840	3190	3540	3890			
										30	2250	2615	2985	3350	3720	4085			
										10 LT	2620	3050	3475	3905	4335	4760			
10 HT	2250	2615	2985	3350	3720	4085													
600/70 R 30	152 D	DW 20 B	DW 18 L ; W 18 L	611	1602	711	4774	750	SPL	km/h - bar	0.6	0.8	1.0	1.2	1.4	1.6			
										65	1955	2275	2595	2915	3235	3550			
										50	2055	2390	2725	3060	3395	3730			
										40	2140	2490	2840	3190	3540	3890			
										30	2250	2615	2985	3350	3720	4085			
										10 LT	2620	3050	3475	3905	4335	4760			
10 HT	2250	2615	2985	3350	3720	4085													

STD: Standard - SPL: Special

Technologies



High Speed



Steel Belted

Technologies



Fuel Economy



Handling and Comfort



High Load Capacity



Reduced Soil Compaction



Self-Cleaning



Traction





AGRIMAX RT 765 (R-1W)

Ø 34"	Tire size	LI/SS	RIM		S.W. (mm)	O.D. (mm)	SLR (mm)	RC (mm)	SRI (index)	Version	Load capacity (kg/tire)									
			Rec.	Alt.																
													km/h - bar	0.6	0.8	1.0	1.2	1.4	1.6	2.0
480/70 R 34	149 D	W 15 L	W 14 L; W 16 L	479	1580	711	4772	750	STD	km/h - bar	0.6	0.8	1.0	1.2	1.4	1.6	2.0	2.4		
										65	1530	1755	2015	2275	2535	2795	3055	3250		
										50	1610	1845	2120	2395	2665	2940	3215	3415		
										40	1675	1925	2210	2495	2780	3065	3350	3560		
										30	1760	2020	2320	2620	2920	3220	3520	3740		
										10 LT	2050	2355	2705	3050	3400	3750	4095	4355		
10 HT	1760	2020	2320	2620	2920	3220	3520	3740												
480/70 R 34	155 D	W 15 L	W 14 L; W 16 L	479	1580	728	4788	750	STD	km/h - bar	0.6	0.8	1.0	1.2	1.4	1.6	2.0	2.4	2.8	3.2
										65	1515	1785	2055	2290	2560	2790	3065	3295	3605	3875
										50	1590	1875	2160	2405	2690	2935	3220	3460	3790	4070
										40	1660	1955	2250	2505	2805	3060	3355	3610	3950	4245
										30	1740	2055	2365	2635	2945	3215	3525	3795	4150	4460
										10 LT	2030	2390	2755	3070	3430	3745	4105	4420	4835	5195
10 HT	1740	2055	2365	2635	2945	3215	3525	3795	4150	4460										
480/70 R 34	155 D	W 15 L	W 14 L; W 16 L	479	1580	728	4788	750	SPL	km/h - bar	0.6	0.8	1.0	1.2	1.4	1.6	2.0	2.4	2.8	3.2
										65	1515	1785	2055	2290	2560	2790	3065	3295	3605	3875
										50	1590	1875	2160	2405	2690	2935	3220	3460	3790	4070
										40	1660	1955	2250	2505	2805	3060	3355	3610	3950	4245
										30	1740	2055	2365	2635	2945	3215	3525	3795	4150	4460
										10 LT	2030	2390	2755	3070	3430	3745	4105	4420	4835	5195
10 HT	1740	2055	2365	2635	2945	3215	3525	3795	4150	4460										
480/70 R 34	149 D	W 15 L	W 14 L; W 16 L	479	1580	711	4772	750	SPL	km/h - bar	0.6	0.8	1.0	1.2	1.4	1.6	2.0	2.4		
										65	1530	1755	2015	2275	2535	2795	3055	3250		
										50	1610	1845	2120	2395	2665	2940	3215	3415		
										40	1675	1925	2210	2495	2780	3065	3350	3560		
										30	1760	2020	2320	2620	2920	3220	3520	3740		
										10 LT	2050	2355	2705	3050	3400	3750	4095	4355		
10 HT	1760	2020	2320	2620	2920	3220	3520	3740												
520/70 R 34	148 D	W 16 L	W 15 L; W 18 L	516	1640	739	4927	775	STD	km/h - bar	0.6	0.8	1.0	1.2	1.4	1.6				
										65	1735	2020	2300	2585	2870	3150				
										50	1825	2120	2420	2715	3140	3310				
										40	1900	2210	2520	2830	3140	3450				
										30	1995	2320	2650	2975	3300	3625				
										10 LT	2325	2705	3085	3465	3845	4225				
10 HT	1995	2320	2650	2975	3300	3625														
520/70 R 34	148 D	W 16 L	W 15 L; W 18 L	516	1640	739	4927	775	SPL	km/h - bar	0.6	0.8	1.0	1.2	1.4	1.6				
										65	1735	2020	2300	2585	2870	3150				
										50	1825	2120	2420	2715	3140	3310				
										40	1900	2210	2520	2830	3140	3450				
										30	1995	2320	2650	2975	3300	3625				
										10 LT	2325	2705	3085	3465	3845	4225				
10 HT	1995	2320	2650	2975	3300	3625														
Ø 38"	480/70 R 38	145 D	W 15 L	W 14 L; W 16 L	479	1681	764	5055	800	STD	km/h - bar	0.6	0.8	1.0	1.2	1.4	1.6			
											65	1595	1860	2120	2380	2640	2900			
											50	1675	1950	2225	2500	2775	3045			
											40	1750	2040	2325	2610	2895	3180			
											30	1835	2135	2435	2735	3035	3335			
											10 LT	2140	2490	2840	3190	3540	3890			
10 HT	1935	2135	2435	2735	3035	3335														
480/70 R 38	145 D	W 15 L	W 14 L; W 16 L	479	1681	764	5055	800	SPL	km/h - bar	0.6	0.8	1.0	1.2	1.4	1.6				
										65	1595	1860	2120	2380	2640	2900				
										50	1675	1950	2225	2500	2775	3045				
										40	1750	2040	2325	2610	2895	3180				
										30	1835	2135	2435	2735	3035	3335				
										10 LT	2140	2490	2840	3190	3540	3890				
10 HT	1835	2135	2435	2735	3035	3335														

STD: Standard - SPL: Special

Technologies



High Speed



Steel Belted

Performance



Fuel Economy



Handling and Comfort



High Load Capacity



Reduced Soil Compaction



Self-Cleaning



Traction



AGRIMAX RT 765 (R-1W)

Ø 38"	Tire size	LI/SS	RIM		S.W. (mm)	O.D. (mm)	SLR (mm)	RC (mm)	SRI (index)	Version	Load capacity (kg/tire)									
			Rec.	Alt.																
											km/h - bar	0.6	0.8	1.0	1.2	1.4	1.6			
520/70 R 38	150 D	W 16 L	W 15 L ; W 18 L	516	1749	793	5300	825	STD	65	1845	2145	2450	2750	3050	3350				
										50	1940	2255	2570	2890	3205	3520				
										40	2020	2350	2680	3010	3340	3670				
										30	2125	2470	2815	3165	3510	3855				
										10 LT	2470	2875	3280	3685	4090	4490				
										10 HT	2125	2470	2815	3165	3510	3855				
										km/h - bar	0.6	0.8	1.0	1.2	1.4	1.6				
520/70 R 38	150 D	W 16 L	W 15 L ; W 18 L	516	1749	793	5300	825	SPL	65	1845	2145	2450	2750	3050	3350				
										50	1940	2255	2570	2890	3205	3520				
										40	2020	2350	2680	3010	3340	3670				
										30	2125	2470	2815	3165	3510	3855				
										10 LT	2470	2875	3280	3685	4090	4490				
										10 HT	2125	2470	2815	3165	3510	3855				
										km/h - bar	0.6	0.8	1.0	1.2	1.4	1.6				
580/70 R 38	155 D	W 18 L	-	577	1827	821	5471	875	STD	65	2135	2480	2830	3180	3530	3875				
										50	2240	2605	2975	3340	3705	4070				
										40	2335	2720	3100	3485	3865	4245				
										30	2455	2855	3260	3660	4060	4460				
										10 LT	2860	3325	3795	4260	4730	5195				
										10 HT	2455	2855	3260	3660	4060	4460				
										km/h - bar	0.6	0.8	1.0	1.2	1.4	1.6				
580/70 R 38	155 D	W 18 L	-	577	1827	821	5471	875	SPL	65	2135	2480	2830	3180	3530	3875				
										50	2240	2605	2975	3340	3705	4070				
										40	2335	2720	3100	3485	3865	4245				
										30	2455	2855	3260	3660	4060	4460				
										10 LT	2860	3325	3795	4260	4730	5195				
										10 HT	2455	2855	3260	3660	4060	4460				
										km/h - bar	0.6	0.8	1.0	1.2	1.4	1.6				
580/70 R 38	180 A8	W 18 L	-	577	1827	821	5505	875	SB	50	3180	3875	4490	4990	5460	5890	6310	6710	7090	7280
										40	3180	3875	4930	5480	6000	6470	6930	7370	7790	8000
										30	3405	4150	5280	5860	6420	6920	7420	7890	8340	8560
										25	3535	4305	5470	6080	6660	7180	7690	8180	8650	8880
										km/h - bar	1.2	1.6	2.0	2.4	2.8	3.2	3.6	4.0	4.4	4.6
620/70 R 38	170 D	DW 20 B	DW 18 L ; W 18 L	625	1833	828	5591	875	STD	65	2340	2760	3180	3540	3960	4320	4740	5100	5580	6000
										50	2460	2900	3340	3720	4160	4540	4980	5355	5860	6300
										40	2565	3025	3485	3880	4340	4735	5195	5585	6115	6570
										30	2695	3175	3660	4075	4555	4970	5455	5865	6420	6900
										10 LT	3140	3700	4265	4745	5310	5790	6355	6835	7480	8040
										10 HT	2695	3175	3660	4075	4555	4970	5455	5865	6420	6900
										km/h - bar	0.6	0.8	1.0	1.2	1.4	1.6	2.0	2.4	2.8	3.2
620/70 R 38	170 D	DW 20 B	DW 18 L ; W 18 L	625	1833	828	5591	875	SPL	65	2340	2760	3180	3540	3960	4320	4740	5100	5580	6000
										50	2460	2900	3340	3720	4160	4540	4980	5355	5860	6300
										40	2565	3025	3485	3880	4340	4735	5195	5585	6115	6570
										30	2695	3175	3660	4075	4555	4970	5455	5865	6420	6900
										10 LT	3140	3700	4265	4745	5310	5790	6355	6835	7480	8040
										10 HT	2695	3175	3660	4075	4555	4970	5455	5865	6420	6900
										km/h - bar	0.6	0.8	1.0	1.2	1.4	1.6	2.0	2.4	2.8	3.2
650/75 R 38	169 D	DW 21 B	DW 20 B ; DW 23 B	655	1941	874	5820	925	STD	65	2730	3135	3600	4060	4525	4990	5455	5975	6355	5800
										50	2865	3290	3780	4265	4755	5240	5725	6225	6725	6090
										40	2990	3435	3945	4450	4960	5470	5975	6475	6975	6355
										30	3135	3605	4140	4670	5205	5740	6270	6770	7270	6670
										10 LT	3655	4200	4825	5445	6065	6690	7310	7775	8310	7775
										10 HT	3135	3605	4140	4670	5205	5740	6270	6770	7270	6670
										km/h - bar	0.6	0.8	1.0	1.2	1.4	1.6	2.0	2.4	2.8	3.2

Technologies



High Speed



Steel Belted

Performance



Fuel Economy



Handling and Comfort



High Load Capacity



Reduced Soil Compaction



Self-Cleaning



Traction

STD: Standard - SPL: Special - SB: Steel Belted



Ø 38"	Tire size	LI/SS	RIM		S.W. (mm)	O.D. (mm)	SLR (mm)	RC (mm)	SRI (index)	Version	Load capacity (kg/tire)										
			Rec.	Alt.							km/h - bar	0.6	0.8	1.0	1.2	1.4	1.6	2.0	2.4	2.8	3.2
710/70 R 38	175 D/ 178 A8	DW 23 B	-	716	1959	859	5751	925	STD	km/h - bar	0.6	0.8	1.0	1.2	1.4	1.6	2.0	2.4	2.8	3.2	
										65	2695	3175	3660	4075	4555	4970	5455	5865	6420	6900	
										50	2830	3335	3840	4275	4785	5220	5725	6160	6740	7245	
										40	2925	3450	3975	4425	4950	5400	5925	6375	6975	7500	
										30	3095	3655	4210	4685	5240	5715	6270	6745	7380	7935	
										10 LT	3610	4255	4905	5460	6105	6660	7310	7865	8605	9250	
										10 HT	3095	3655	4210	4685	5240	5715	6270	6745	7380	7935	
710/70 R 38	171 D/ 174 A8	DW 23 B	-	716	1959	859	5751	925	STD	km/h - bar	0.6	0.8	1.0	1.2	1.4	1.6	2.0	2.4	2.8	3.2	
										65	2915	3395	3870	4350	4825	5300					
										50	3065	3565	4065	4565	5065	5565					
										40	3195	3720	4240	4765	5285	5805					
										30	3355	3905	4450	5000	5550	6095					
										10 LT	3910	4550	5190	5830	6470	7105					
										10 HT	3355	3905	4450	5000	5550	6095					
710/70 R 38	175 D/ 178 A8	DW 23 B	-	716	1959	859	5751	925	SPL	km/h - bar	0.6	0.8	1.0	1.2	1.4	1.6	2.0	2.4	2.8	3.2	
										65	2695	3175	3660	4075	4555	4970	5455	5865	6420	6900	
										50	2830	3335	3840	4275	4785	5220	5725	6160	6740	7245	
										40	2925	3450	3975	4425	4950	5400	5925	6375	6975	7500	
										30	3095	3655	4210	4685	5240	5715	6270	6745	7380	7935	
										10 LT	3610	4255	4905	5460	6105	6660	7310	7865	8605	9250	
										10 HT	3095	3655	4210	4685	5240	5715	6270	6745	7380	7935	
710/70 R 38	166 D	DW 23 B	-	716	1959	859	5751	925	SPL	km/h - bar	0.6	0.8	1.0	1.2	1.4	1.6	2.0	2.4	2.8	3.2	
										65	2915	3395	3870	4350	4825	5300					
										50	3065	3565	4065	4565	5065	5565					
										40	3195	3720	4240	4765	5285	5805					
										30	3355	3905	4450	5000	5550	6095					
										10 LT	3910	4550	5190	5830	6470	7105					
										10 HT	3355	3905	4450	5000	5550	6095					
710/70 R 38	166 D	DW 23 B	-	716	1959	859	5751	925	STD	km/h - bar	0.6	0.8	1.0	1.2	1.4	1.6	2.0	2.4	2.8	3.2	
										65	2915	3395	3870	4350	4825	5300					
										50	3065	3565	4065	4565	5065	5565					
										40	3195	3720	4240	4765	5285	5805					
										30	3355	3905	4450	5000	5550	6095					
										10 LT	3910	4550	5190	5830	6470	7105					
										10 HT	3355	3905	4450	5000	5550	6095					
Ø 42"	620/70 R 42	160 D	DW 20 B	DW 18 L	625	1935	876	5742	925	STD	km/h - bar	0.6	0.8	1.0	1.2	1.4	1.6	2.0	2.4	2.8	3.2
											65	2475	2880	3285	3690	4095	4500				
											50	2600	3025	3450	3875	4300	4725				
											40	2715	3160	3600	4045	4490	4930				
											30	2850	3315	3780	4245	4710	5175				
											10 LT	3320	3860	4405	4945	5490	6030				
											10 HT	2850	3315	3780	4245	4710	5175				
620/70 R 42	166 D	DW 20 B	DW 18 L	625	1935	876	5801	925	STD	km/h - bar	0.6	0.8	1.0	1.2	1.4	1.6	2.0	2.4	2.8	3.2	
										65	2495	2865	3290	3710	4135	4560	4985	5300			
										50	2620	3010	3455	3900	4345	4790	5235	5565			
										40	2730	3135	3600	4065	4530	4995	5460	5805			
										30	2865	3295	3780	4270	4755	5245	5730	6095			
										10 LT	3340	3840	4410	4975	5545	6115	6680	7105			
										10 HT	2865	3295	3780	4270	4755	5245	5730	6095			

STD: Standard - SPL: Special

Technologies



High Speed



Steel Belted

Performance



Fuel Economy



Handling and Comfort



High Load Capacity



Reduced Soil Compaction



Self-Cleaning



Traction



TRACTOR

AGRIMAX RT 765 (R-1W)

Ø 42"	Tire size	LI/SS	RIM		S.W. (mm)	O.D. (mm)	SLR (mm)	RC (mm)	SRI (index)	Version	Load capacity (kg/tire)									
			Rec.	Alt.																
											km/h - bar	0.6	0.8	1.0	1.2	1.4	1.6	2.0	2.4	
620/70 R 42	166 D	DW 20 B	DW 18 L	625	1935	876	5801	925	SPL	km/h - bar	0.6	0.8	1.0	1.2	1.4	1.6	2.0	2.4		
										65	2495	2865	3290	3710	4135	4560	4985	5300		
										50	2620	3010	3455	3900	4345	4790	5235	5565		
										40	2730	3135	3600	4065	4530	4995	5460	5805		
										30	2865	3295	3780	4270	4755	5245	5730	6095		
										10 LT	3340	3840	4410	4975	5545	6115	6680	7105		
10 HT	2865	3295	3780	4270	4755	5245	5730	6095												
620/70 R 42	173 D	DW 20 B	DW 18 L	625	1935	876	5804	925	STD	km/h - bar	0.6	0.8	1.0	1.2	1.4	1.6	2.0	2.4	2.8	3.2
										65	2535	2990	3445	3835	4290	4680	5135	5525	6045	6500
										50	2665	3140	3620	4030	4505	4915	5395	5805	6350	6825
										40	2780	3280	3775	4205	4700	5130	5625	6055	6625	7120
										30	2920	3440	3965	4415	4935	5385	5910	6355	6955	7475
										10 LT	3400	4010	4620	5140	5750	6275	6885	7405	8105	8710
10 HT	2920	3440	3965	4415	4935	5385	5910	6355	6955	7475										
620/70 R 42	173 D	DW 20 B	DW 18 L	625	1935	876	5804	925	SPL	km/h - bar	0.6	0.8	1.0	1.2	1.4	1.6	2.0	2.4	2.8	3.2
										65	2535	2990	3445	3835	4290	4680	5135	5525	6045	6500
										50	2665	3140	3620	4030	4505	4915	5395	5805	6350	6825
										40	2780	3280	3775	4205	4700	5130	5625	6055	6625	7120
										30	2920	3440	3965	4415	4935	5385	5910	6355	6955	7475
										10 LT	3400	4010	4620	5140	5750	6275	6885	7405	8105	8710
10 HT	2920	3440	3965	4415	4935	5385	5910	6355	6955	7475										
620/70 R 42	160 D	DW 20 B	DW 18 L	625	1935	876	5742	925	SPL	km/h - bar	0.6	0.8	1.0	1.2	1.4	1.6				
										65	2475	2880	3285	3690	4095	4500				
										50	2600	3025	3450	3875	4300	4725				
										40	2715	3160	3600	4045	4490	4930				
										30	2850	3315	3780	4245	4710	5175				
										10 LT	3320	3860	4405	4945	5490	6030				
10 HT	2850	3315	3780	4245	4710	5175														
650/75 R 42	170 D	DW21B	DW 20B ; DW 23B	655	2043	916	6147	975	STD	km/h - bar	0.6	0.8	1.0	1.2	1.4	1.6	2.0	2.4		
										65	2820	3240	3720	4200	4680	5160	5640	6000		
										50	2965	3405	3910	4410	4915	5420	5925	6300		
										40	3090	3550	4075	4600	5125	5655	6180	6570		
										30	3245	3730	4280	4830	5385	5935	6490	6900		
										10 LT	3780	4345	4985	5630	6275	6915	7560	8040		
10 HT	3245	3730	4280	4830	5385	5935	6490	6900												
710/70 R 42	176 D / 179 A8	DW 23 B	DW 25 B	716	2061	922	6174	975	STD	km/h - bar	0.6	0.8	1.0	1.2	1.4	1.6	2.0	2.4	2.8	
										65	3055	3550	4050	4545	5045	5540	6110	6465	7100	
										50	3210	3730	4250	4775	5295	5815	6415	6785	7455	
										40	3335	3875	4420	4960	5505	6045	6665	7055	7750	
										30	3515	4085	4655	5230	5800	6370	7025	7435	8165	
										10 LT	4095	4760	5425	6090	6760	7425	8185	8660	9515	
10 HT	3515	4085	4655	5230	5800	6370	7025	7435	8165											
710/70 R 42	173 D / 176 A8	DW 23 B	DW 25 B	716	2061	922	6174	975	STD	km/h - bar	0.6	0.8	1.0	1.2	1.4	1.6	2.0	2.4		
										65	3120	3640	4095	4550	5005	5395	5980	6500		
										50	3280	3825	4300	4780	5260	5665	6280	6825		
										40	3410	3980	4475	4970	5470	5895	6535	7120		
										30	3590	4190	4710	5235	5760	6205	6880	7475		
										10 LT	4185	4880	5490	6100	6710	7230	8015	8710		
10 HT	3590	4190	4710	5235	5760	6205	6880	7475												

Technologies



Performance



STD: Standard - SPL: Special



AGRIMAX RT 765 (R-1W)

Ø 42"	Tire size	LI/SS	RIM		S.W. (mm)	O.D. (mm)	SLR (mm)	RC (mm)	SRI (index)	Version	Load capacity (kg/tire)								
			Rec.	Alt.							km/h - bar	0.6	0.8	1.0	1.2	1.4	1.6	2.0	2.4
710/70 R 42	173 D	DW 23 B	DW 25 B	716	2061	922	6174	975	STD	65	3055	3510	4030	4550	5070	5590	6110	6500	
										50	3210	3690	4235	4780	5325	5870	6420	6825	
										40	3350	3845	4415	4985	5555	6125	6695	7120	
										30	3515	4040	4635	5235	5835	6430	7030	7475	
										10 LT	4095	4705	5405	6100	6795	7495	8190	8710	
										10 HT	3515	4040	4635	5235	5835	6430	7030	7475	
710/70 R 42	176 D/ 179 A8	DW 23 B	DW 25 B	716	2061	922	6174	975	SPL	km/h - bar	0.6	0.8	1.0	1.2	1.4	1.6	2.0	2.4	2.8
										65	3055	3550	4050	4545	5045	5540	6110	6465	7100
										50	3210	3730	4250	4775	5295	5815	6415	6785	7455
										40	3335	3875	4420	4960	5505	6045	6665	7055	7750
										30	3515	4085	4655	5230	5800	6370	7025	7435	8165
										10 LT	4095	4760	5425	6090	6760	7425	8185	8660	9515
10 HT	3515	4085	4655	5230	5800	6370	7025	7435	8165										
Ø 46"	620/70 R 46	162 D	DW 20 B	-	625	2036	924	6106	975	STD	km/h - bar	0.6	0.8	1.0	1.2	1.4	1.6		
											65	2615	3040	3470	3895	4325	4750		
											50	2745	3195	3645	4095	4545	4990		
											40	2865	3335	3800	4270	4740	5205		
											30	3010	3500	3990	4485	4975	5465		
											10 LT	3505	4075	4650	5220	5795	6365		
10 HT	3010	3500	3990	4485	4975	5465													
620/70 R 46	162 D	DW 20 B	-	625	2036	924	6106	975	SPL	km/h - bar	0.6	0.8	1.0	1.2	1.4	1.6			
										65	2615	3040	3470	3895	4325	4750			
										50	2745	3195	3645	4095	4545	4990			
										40	2865	3335	3800	4270	4740	5205			
										30	3010	3500	3990	4485	4975	5465			
										10 LT	3505	4075	4650	5220	5795	6365			
10 HT	3010	3500	3990	4485	4975	5465													

STD: Standard - SPL: Special

Technologies



High Speed



Steel Belted

Performance



Fuel Economy



Handling and Comfort



High Load Capacity



Reduced Soil Compaction



Self-Cleaning



Traction





TRACTOR

Radial



AGRIMAX RT 855 (R-1W)

AGRIMAX RT 855 provides excellent traction and comfort properties. Mainly designed for soil tillage and both field and road transport, some sizes are also suitable for spraying, and vineyard harvesting. AGRIMAX RT 855 has excellent self-cleaning features that allow for a quick change from field operations to road usage.

Ø 16"	Tire size	LI/SS	RIM		S.W. (mm)	O.D. (mm)	SLR (mm)	RC (mm)	SRI (index)	Version	Load capacity (kg/tire)											
			Rec.	Alt.							km/h - bar											
											0.8	1.2	1.6	2.0	2.4	2.8	3.2	3.6				
180/95 R 16 (6.50 R 16)	105 A8/B	5.5 F	6.0 F	185	760	340	2265	360	STD	50	430	550	670	735	790	865	925	-				
										40	430	550	670	735	790	865	925	-				
										30	460	585	715	785	845	925	990	-				
										10	505	655	795	950	1085	1130	1255	1390				
210/95 R 16 (7.50 R 16)	106 A8/B	W 7	W 6 ; 6 LB	214	806	360	2387	390	STD	50	450	515	590	665	745	820	885	950				
										40	450	515	590	665	745	820	885	950				
										30	480	555	635	715	800	880	950	1020				
										10 LT	600	690	795	895	995	1100	1190	1275				
										10 HT	480	555	635	715	800	880	950	1020				
210/95 R 16 (7.50 R 16)	116 A8	W 7	W 6 ; 6 LB	214	806	350	2353	390	IMP	km/h - bar	2.4											
										40 Free Rolling	1250											
Ø 18"	210/95 R 18 (7.50 R 18)	108 A8/B	W 7	W 6	214	855	385	2565	410	STD	50	470	540	620	700	780	860	930	1000			
											40	470	540	620	700	780	860	930	1000			
											30	505	580	665	750	835	925	1000	1070			
											10 LT	630	725	835	940	1050	1155	1250	1340			
											10 HT	505	580	665	750	835	925	1000	1070			
210/95 R 18 (7.50 R 18)	122 A8	W 7	W 6	214	855	378	2565	410	IMP	km/h - bar	2.8											
										40 Free Rolling	1500											
250/80 R 18	125 A8/ 125 B	W 8	W 7 ; W 9	250	835	375	2539	410	STD	50	580	680	780	875	975	1060	1175	1240	1355	1470	1570	1650
										40	580	680	780	875	975	1060	1175	1240	1355	1470	1570	1650
										30	620	730	835	940	1045	1135	1260	1330	1455	1580	1685	1770
										10 LT	780	910	1045	1175	1310	1420	1575	1665	1820	1975	2105	2215
										10 HT	620	730	835	940	1045	1135	1260	1330	1455	1580	1685	1770
										km/h - bar	0.6	0.8	1.0	1.2	1.4	1.6	2.0	2.4	2.8	3.2	3.6	4.0
Ø 20"	210/90 R 20 (8.3 R 20)	110 A8/B	W 7	W 6	211	890	412	2681	425	STD	50	500	575	660	745	830	915	990	1060			
											40	500	575	660	745	830	915	990	1060			
											30	535	615	705	795	890	980	1060	1135			
											10 LT	670	770	885	1000	1115	1230	1330	1425			
											10 HT	535	615	705	795	890	980	1060	1135			
210/95 R 20 (7.50 R 20)	110 A8/B	W 7	W 6	214	908	418	2749	450	STD	50	500	575	660	745	830	915	990	1060				
										40	500	575	660	745	830	915	990	1060				
										30	535	615	705	795	890	980	1060	1135				
										10 LT	670	770	885	1000	1115	1230	1330	1425				
										10 HT	535	615	705	795	890	980	1060	1135				
										km/h - bar	0.6	0.8	1.0	1.2	1.4	1.6	2.0	2.4				

STD: Standard - IMP: Implement

Performance





TRACTOR

AGRIMAX RT 855 (R-1W)

Ø 20"	Tire size	LI/SS	RIM		S.W. (mm)	O.D. (mm)	SLR (mm)	RC (mm)	SRI (index)	Version	Load capacity (kg/tire)								
			Rec.	Alt.							km/h - bar	0.6	0.8	1.0	1.2	1.4	1.6	2.0	2.4
250/85 R 20 (9.5 R 20)	116 A8/B	W 8	W 7 ; W 9	250	940	424	2812	450	STD	50	590	675	775	875	975	1075	1165	1250	
										40	590	675	775	875	975	1075	1165	1250	
										30	630	725	835	940	1050	1155	1250	1340	
										10 LT	790	905	1040	1175	1310	1445	1560	1675	
										10 HT	630	725	835	940	1050	1155	1250	1340	
280/85 R 20 (11.2 R 20)	112 A8/B	W 10	W 9	292	984	441	2952	475	STD	50	620	720	820	920	1020	1120	1200		
										40	620	720	820	920	1020	1120	1200		
										30	660	770	880	985	1095	1200	1300	1400	
										10 LT	830	965	1100	1235	1370	1505	1640	1775	
										10 HT	660	770	880	985	1095	1200	1300	1400	
280/85 R 20 (11.2 R 20)	122 A8/B	W 10	W 9	292	984	447	2977	475	STD	50	615	720	825	930	1035	1125	1335	1500	
										40	615	720	825	930	1035	1125	1335	1500	
										30	660	775	885	1000	1110	1205	1430	1605	
										10 LT	825	965	1110	1250	1390	1510	1790	2010	
										10 HT	660	775	885	1000	1110	1205	1430	1605	
320/85 R 20 (12.4 R 20)	119 A8/B	W 11	W 9 ; W 10	329	1052	467	3100	500	STD	50	750	875	995	1120	1240	1360	1480		
										40	750	875	995	1120	1240	1360	1480		
										30	805	935	1070	1200	1330	1460	1590		
										10 LT	1005	1170	1335	1500	1665	1825	1990		
										10 HT	805	935	1070	1200	1330	1460	1590		
Ø 22"	250/85 R 22 (9.5 R 22)	113 A8/B	W 8	W 7	251	985	453	2964	475	STD	50	545	625	715	805	900	990	1070	1150
											40	545	625	715	805	900	990	1070	1150
											30	585	670	770	865	965	1065	1150	1235
											10 LT	730	835	960	1085	1210	1330	1440	1545
											10 HT	585	670	770	865	965	1065	1150	1235
250/85 R 22	113 A8/B	W 8	W 7	251	985	453	2964	475	SPL	50	545	625	715	805	900	990	1070	1150	
										40	545	625	715	805	900	990	1070	1150	
										30	585	670	770	865	965	1065	1150	1235	
										10 LT	730	835	960	1085	1210	1330	1440	1545	
										10 HT	585	670	770	865	965	1065	1150	1235	
Ø 24"	250/85 R 24 (9.5 R 24)	109 A8/B	W 8	W 7 ; W 9	251	1036	475	3104	500	STD	50	570	660	755	845	940	1030	1105	
											40	570	660	755	845	940	1030	1105	
											30	610	710	810	910	1010	1105	1185	
											10 LT	765	890	1015	1140	1265	1385	1505	
											10 HT	610	710	810	910	1010	1105	1185	
250/85 R 24 (9.5 R 24)	109 A8/B	W 8	W 7 ; W 9	251	1036	475	3104	500	SPL	50	570	660	755	845	940	1030	1105		
										40	570	660	755	845	940	1030	1105		
										30	610	710	810	910	1010	1105	1185		
										10 LT	765	890	1015	1140	1265	1385	1505		
										10 HT	610	710	810	910	1010	1105	1185		
280/85 R 24 (11.2 R 24)	115 A8/B	W 10	W 9	292	1086	492	3224	525	STD	50	670	780	890	1000	1110	1215	1315		
										40	670	780	890	1000	1110	1215	1315		
										30	720	840	955	1075	1190	1305	1415		
										10 LT	900	1045	1190	1340	1485	1630	1775		
										10 HT	720	840	955	1075	1190	1305	1415		

Performance



STD: Standard - SPL: Special





TRACTOR

AGRIMAX RT 855 (R-1W)

Ø 24"	Tire size	LI/SS	RIM		S.W. (mm)	O.D. (mm)	SLR (mm)	RC (mm)	SRI (index)	Version	Load capacity (kg/tire)						
			Rec.	Alt.							km/h - bar	0.6	0.8	1.0	1.2	1.4	1.6
280/85 R 24 (11.2 R 24)	115 A8/B	W 10	W 9	292	1086	492	3224	525	SPL	km/h - bar	0.6	0.8	1.0	1.2	1.4	1.6	
										50	670	780	890	1000	1110	1215	
										40	670	780	890	1000	1110	1215	
										30	720	840	955	1075	1190	1305	
										10 LT	900	1045	1190	1340	1485	1630	
										10 HT	720	840	955	1075	1190	1305	
320/85 R 24 (12.4 R 24)	122 A8/B	W 11	W 9 ; W 10	329	1154	490	3424	550	STD	km/h - bar	0.6	0.8	1.0	1.2	1.4	1.6	
										50	825	960	1095	1230	1365	1500	
										40	825	960	1095	1230	1365	1500	
										30	885	1030	1175	1320	1465	1605	
										10 LT	1110	1290	1470	1650	1830	2010	
										10 HT	885	1030	1175	1320	1465	1605	
320/85 R 24 (12.4 R 24)	122 A8/B	W 11	W 9 ; W 10	329	1154	519	3424	550	SPL	km/h - bar	0.6	0.8	1.0	1.2	1.4	1.6	
										50	825	960	1095	1230	1365	1500	
										40	825	960	1095	1230	1365	1500	
										30	885	1030	1175	1320	1465	1605	
										10 LT	1110	1290	1470	1650	1830	2010	
										10 HT	885	1030	1175	1320	1465	1605	
340/85 R 24 (13.6 R 24)	125 A8/B	W 12	W 11	353	1188	531	3540	575	STD	km/h - bar	0.6	0.8	1.0	1.2	1.4	1.6	
										50	910	1060	1205	1355	1505	1650	
										40	910	1060	1205	1355	1505	1650	
										30	975	1135	1295	1455	1615	1770	
										10 LT	1220	1420	1620	1820	2020	2215	
										10 HT	975	1135	1295	1455	1615	1770	
340/85 R 24 (13.6 R 24)	125 A8/B	W 12	W 11	353	1188	531	3540	575	SPL	km/h - bar	0.6	0.8	1.0	1.2	1.4	1.6	
										50	910	1060	1205	1355	1505	1650	
										40	910	1060	1205	1355	1505	1650	
										30	975	1135	1295	1455	1615	1770	
										10 LT	1220	1420	1620	1820	2020	2215	
										10 HT	975	1135	1295	1455	1615	1770	
380/85 R 24 (14.9 R 24)	131 A8/B	W 12	W 11 ; W 13	380	1256	554	3720	600	STD	km/h - bar	0.6	0.8	1.0	1.2	1.4	1.6	
										50	1075	1250	1425	1600	1775	1950	
										40	1075	1250	1425	1600	1775	1950	
										30	1150	1340	1530	1715	1905	2090	
										10 LT	1440	1675	1910	2145	2380	2615	
										10 HT	1150	1340	1530	1715	1905	2090	
380/85 R 24 (14.9 R 24)	131 A8/B	W 12	W 11 ; W 13	380	1256	554	3720	600	SPL	km/h - bar	0.6	0.8	1.0	1.2	1.4	1.6	
										50	1075	1250	1425	1600	1775	1950	
										40	1075	1250	1425	1600	1775	1950	
										30	1150	1340	1530	1715	1905	2090	
										10 LT	1440	1675	1910	2145	2380	2615	
										10 HT	1150	1340	1530	1715	1905	2090	
420/85 R 24 (16.9 R 24)	137 A8/B	W 15 L	W 14 L ; W 13	450	1324	582	3900	625	STD	km/h - bar	0.6	0.8	1.0	1.2	1.4	1.6	
										50	1265	1475	1680	1890	2095	2300	
										40	1265	1475	1680	1890	2095	2300	
										30	1360	1580	1800	2025	2245	2465	
										10 LT	1700	1975	2255	2530	2810	3085	
										10 HT	1360	1580	1800	2025	2245	2465	
420/85 R 24 (16.9 R 24)	137 A8/B	W 15 L	W 14 L ; W 13	450	1324	582	3900	625	SPL	km/h - bar	0.6	0.8	1.0	1.2	1.4	1.6	
										50	1265	1475	1680	1890	2095	2300	
										40	1265	1475	1680	1890	2095	2300	
										30	1360	1580	1800	2025	2245	2465	
										10 LT	1700	1975	2255	2530	2810	3085	
										10 HT	1360	1580	1800	2025	2245	2465	

Performance



STD: Standard - SPL: Special





TRACTOR

AGRIMAX RT 855 (R-1W)

Ø 28"	Tire size	LI/SS	RIM		S.W. (mm)	O.D. (mm)	SLR (mm)	RC (mm)	SRI (index)	Version	Load capacity (kg/tire)									
			Rec.	Alt.							km/h - bar									
											0.6	0.8	1.0	1.2	1.4	1.6				
250/85 R 28 (9.5 R 28)	112 A8/B	W 8	W 7; W 9	251	1137	519	3421	550	STD	50	620	720	820	920	1020	1120				
										40	620	720	820	920	1020	1120				
										30	660	770	880	985	1095	1200				
										10 LT	830	965	1100	1235	1370	1505				
										10 HT	660	770	880	985	1095	1200				
										50	620	720	820	920	1020	1120				
250/85 R 28 (9.5 R 28)	112 A8/B	W 8	W 7; W 9	251	1137	519	3421	550	SPL	50	620	720	820	920	1020	1120				
										40	620	720	820	920	1020	1120				
										30	660	770	880	985	1095	1200				
										10 LT	830	965	1100	1235	1370	1505				
										10 HT	660	770	880	985	1095	1200				
										50	620	720	820	920	1020	1120				
280/85 R 28 (11.2 R 28)	118 A8/B	W 10	W 9	292	1187	545	3558	575	STD	50	730	845	965	1085	1205	1320				
										40	730	845	965	1085	1205	1320				
										30	780	910	1035	1165	1290	1415				
										10 LT	975	1135	1295	1455	1615	1770				
										10 HT	780	910	1035	1165	1290	1415				
										50	730	845	965	1085	1205	1320				
280/85 R 28 (11.2 R 28)	118 A8/B	W 10	W 9	292	1187	545	3558	575	SPL	50	730	845	965	1085	1205	1320				
										40	730	845	965	1085	1205	1320				
										30	780	910	1035	1165	1290	1415				
										10 LT	975	1135	1295	1455	1615	1770				
										10 HT	780	910	1035	1165	1290	1415				
										50	730	845	965	1085	1205	1320				
320/85 R 28 (12.4 R 28)	124 A8/B	W 11	W 9; W 10	329	1255	569	3743	600	STD	50	880	1025	1170	1315	1460	1600				
										40	880	1025	1170	1315	1460	1600				
										30	945	1100	1255	1410	1565	1715				
										10 LT	1180	1375	1570	1760	1955	2145				
										10 HT	945	1100	1255	1410	1565	1715				
										50	880	1025	1170	1315	1460	1600				
320/85 R 28 (12.4 R 28)	124 A8/B	W 11	W 9; W 10	329	1255	569	3743	600	SPL	50	880	1025	1170	1315	1460	1600				
										40	880	1025	1170	1315	1460	1600				
										30	945	1100	1255	1410	1565	1715				
										10 LT	1180	1375	1570	1760	1955	2145				
										10 HT	945	1100	1255	1410	1565	1715				
										50	880	1025	1170	1315	1460	1600				
340/85 R 28 (13.6 R 28)	127 A8/B	W 12	W 11	353	1289	588	3890	625	STD	50	965	1120	1280	1435	1595	1750				
										40	965	1120	1280	1435	1595	1750				
										30	1035	1200	1370	1540	1710	1875				
										10 LT	1290	1505	1715	1925	2135	2345				
										10 HT	1035	1200	1370	1540	1710	1875				
										50	965	1120	1280	1435	1595	1750				
340/85 R 28 (13.6 R 28)	127 A8/B	W 12	W 11	353	1289	588	3890	625	SPL	50	965	1120	1280	1435	1595	1750				
										40	965	1120	1280	1435	1595	1750				
										30	1035	1200	1370	1540	1710	1875				
										10 LT	1290	1505	1715	1925	2135	2345				
										10 HT	1035	1200	1370	1540	1710	1875				
										50	965	1120	1280	1435	1595	1750				
340/85 R 28 (13.6 R 28)	139 A8/B	W 12	W 11	353	1315	603	3963	625	STD	50	950	1120	1290	1435	1605	1750	1920	2070	2260	2430
										40	950	1120	1280	1435	1605	1750	1920	2070	2260	2430
										30	1020	1200	1385	1540	1720	1880	2060	2215	2425	2605
										10 LT	1275	1500	1730	1925	2155	2350	2580	2775	3035	3260
										10 HT	1020	1200	1385	1540	1720	1880	2060	2215	2425	2605
										50	950	1120	1290	1435	1605	1750	1920	2070	2260	2430

Performance



STD: Standard - SPL: Special





TRACTOR

AGRIMAX RT 855 (R-1W)

Ø 28"	Tire size	LI/SS	RIM		S.W. (mm)	O.D. (mm)	SLR (mm)	RC (mm)	SRI (index)	Version	Load capacity (kg/tire)						
			Rec.	Alt.							km/h - bar	0.6	0.8	1.0	1.2	1.4	1.6
380/85 R 28 (14.9 R 28)	133 A8/B	W 12	W 11 ; W 13	380	1357	606	4015	650	STD	50	1135	1320	1505	1690	1875	2060	
										40	1135	1320	1505	1690	1875	2060	
										30	1215	1415	1610	1810	2010	2205	
										10 LT	1525	1770	2020	2270	2520	2765	
										10 HT	1215	1415	1610	1810	2010	2205	
380/85 R 28 (14.9 R 28)	133 A8/B	W 12	W 11 ; W 13	380	1357	606	4015	650	SPL	50	1135	1320	1505	1690	1875	2060	
										40	1135	1320	1505	1690	1875	2060	
										30	1215	1415	1610	1810	2010	2205	
										10 LT	1525	1770	2020	2270	2520	2765	
										10 HT	1215	1415	1610	1810	2010	2205	
420/85 R 28 (16.9 R 28)	139 A8/B	W 15 L	W 13 ; W 14 L	438	1425	638	4241	675	STD	50	1340	1560	1775	1995	2215	2430	
										40	1340	1560	1775	1995	2215	2430	
										30	1435	1670	1905	2140	2375	2605	
										10 LT	1795	2090	2380	2675	2970	3260	
										10 HT	1435	1670	1905	2140	2375	2605	
420/85 R 28 (16.9 R 28)	139 A8/B	W 15 L	W 13 ; W 14 L	438	1425	638	4241	675	SPL	50	1340	1560	1775	1995	2215	2430	
										40	1340	1560	1775	1995	2215	2430	
										30	1435	1670	1905	2140	2375	2605	
										10 LT	1795	2090	2380	2675	2970	3260	
										10 HT	1435	1670	1905	2140	2375	2605	
Ø 30"	380/85 R 30 (14.9 R 30)	135 A8/B	W 12	W 11 ; W 13	380	1408	633	4190	675	STD	50	1200	1400	1595	1790	1985	2180
											40	1200	1400	1595	1790	1985	2180
											30	1285	1495	1705	1915	2125	2335
											10 LT	1610	1875	2140	2400	2665	2925
											10 HT	1285	1495	1705	1915	2125	2335
380/85 R 30 (14.9 R 30)	135 A8/B	W 12	W 11 ; W 13	380	1408	633	4190	675	SPL	50	1200	1400	1595	1790	1985	2180	
										40	1200	1400	1595	1790	1985	2180	
										30	1285	1495	1705	1915	2125	2335	
										10 LT	1610	1875	2140	2400	2665	2925	
										10 HT	1285	1495	1705	1915	2125	2335	
420/85 R 30 (16.9 R 30)	140 A8/B	W 15 L	W 13 ; W 14 L	438	1475	661	4421	700	STD	50	1375	1600	1825	2050	2275	2500	
										40	1375	1600	1825	2050	2275	2500	
										30	1475	1715	1955	2195	2435	2675	
										10 LT	1845	2145	2450	2750	3050	3350	
										10 HT	1475	1715	1955	2195	2435	2675	
420/85 R 30 (16.9 R 30)	140 A8/B	W 15 L	W 13 ; W 14 L	438	1475	661	4421	700	SPL	50	1375	1600	1825	2050	2275	2500	
										40	1375	1600	1825	2050	2275	2500	
										30	1475	1715	1955	2195	2435	2675	
										10 LT	1845	2145	2450	2750	3050	3350	
										10 HT	1475	1715	1955	2195	2435	2675	
460/85 R 30 (18.4 R 30)	145 A8/B	W 16 L	W 14 L ; W 15 L	475	1544	680	4562	725	STD	50	1595	1860	2120	2380	2640	2900	
										40	1595	1860	2120	2380	2640	2900	
										30	1710	1990	2270	2550	2830	3105	
										10 LT	2140	2490	2840	3190	3540	3890	
										10 HT	1710	1990	2270	2550	2830	3105	

Performance



Handling and Comfort



High Load Capacity



Self-Cleaning



Traction

STD: Standard - SPL: Special



Ø 30"	Tire size	LI/SS	RIM		S.W. (mm)	O.D. (mm)	SLR (mm)	RC (mm)	SRI (index)	Version	Load capacity (kg/tire)									
			Rec.	Alt.							km/h - bar	0.6	0.8	1.0	1.2	1.4	1.6			
460/85 R 30 (18.4 R 30)	145 A8/B	W 16 L	W 14 L ; W 15 L	475	1544	680	4562	725	SPL	50	1595	1860	2120	2380	2640	2900				
										40	1595	1860	2120	2380	2640	2900				
										30	1710	1990	2270	2550	2830	3105				
										10 LT	2140	2490	2840	3190	3540	3890				
										10 HT	1710	1990	2270	2550	2830	3105				
										km/h - bar	0.6	0.8	1.0	1.2	1.4	1.6				
460/85 R 30 (18.4 R 30)	156 A8/B	W 16 L	W 14 L ; W 15 L	475	1544	680	4562	725	STD	50	1560	1840	2120	2360	2640	2880	3160	3400	3720	4000
										40	1560	1840	2120	2360	2640	2880	3160	3400	3720	4000
										30	1670	1990	2270	2530	2825	3085	3385	3640	3985	4280
										10 LT	2095	2470	2845	3165	3540	3860	4235	4560	4985	5360
										10 HT	1670	1990	2270	2550	2825	3085	3385	3640	3985	4280
										km/h - bar	0.6	0.8	1.0	1.2	1.4	1.6	2.0	2.4	2.8	3.2
Ø 32"	320/85 R 32 (12.4 R 32)	126 A8/B	W 11	W 9 ; W 10	329	1357	621	4081	650	STD	50	935	1090	1245	1395	1550	1700			
											40	935	1090	1245	1395	1550	1700			
											30	1005	1165	1330	1495	1660	1820			
											10 LT	1255	1460	1665	1870	2075	2280			
											10 HT	1005	1165	1330	1495	1660	1820			
											km/h - bar	0.6	0.8	1.0	1.2	1.4	1.6			
320/85 R 32 (12.4 R 32)	126 A8/B	W 11	W 9 ; W 10	329	1357	621	4081	650	SPL	50	935	1090	1245	1395	1550	1700				
										40	935	1090	1245	1395	1550	1700				
										30	1005	1165	1330	1495	1660	1820				
										10 LT	1255	1460	1665	1870	2075	2280				
										10 HT	1005	1165	1330	1495	1660	1820				
										km/h - bar	0.6	0.8	1.0	1.2	1.4	1.6				
Ø 34"	320/85 R 34 (12.4 R 34)	141 A8/B	W 11	W 9 ; W 10	329	1408	645	4280	675	STD	50	930	1085	1420	1730	1880	2010	2190	2370	2575
											40	930	1085	1420	1730	1880	2010	2190	2370	2575
											30	995	1160	1520	1850	2015	2155	2350	2540	2760
											10 LT	1245	1455	1905	2315	2525	2695	2940	3180	3455
											10 HT	995	1160	1520	1850	2015	2155	2350	2540	2760
											km/h - bar	0.6	0.8	1.2	1.6	2.0	2.4	2.8	3.2	3.6
320/85 R 34 (12.4 R 34)	141 A8/B	W 11	W 9 ; W 10	329	1408	645	4280	675	SPL	50	930	1085	1420	1730	1880	2010	2190	2370	2575	
										40	930	1085	1420	1730	1880	2010	2190	2370	2575	
										30	995	1160	1520	1850	2015	2155	2350	2540	2760	
										10 LT	1245	1455	1905	2315	2525	2695	2940	3180	3455	
										10 HT	995	1160	1520	1850	2015	2155	2350	2540	2760	
										km/h - bar	0.6	0.8	1.2	1.6	2.0	2.4	2.8	3.2	3.6	
380/85 R 34 (14.9 R 34)	137 A8/B	W 12	W 11 ; W 13	380	1509	682	4504	725	STD	50	1265	1475	1680	1890	2095	2300				
										40	1265	1475	1680	1890	2095	2300				
										30	1360	1580	1800	2025	2245	2465				
										10 LT	1700	1975	2255	2530	2810	3085				
										10 HT	1360	1580	1800	2025	2245	2465				
										km/h - bar	0.6	0.8	1.0	1.2	1.4	1.6				
380/85 R 34 (14.9 R 34)	137 A8/B	W 12	W 11 ; W 13	380	1509	682	4504	725	SPL	50	1265	1475	1680	1890	2095	2300				
										40	1265	1475	1680	1890	2095	2300				
										30	1360	1580	1800	2025	2245	2465				
										10 LT	1700	1975	2255	2530	2810	3085				
										10 HT	1360	1580	1800	2025	2245	2465				
										km/h - bar	0.6	0.8	1.0	1.2	1.4	1.6				
420/85 R 34 (16.9 R 34)	142 A8/B	W 15 L	W 13 ; W 14 L	438	1578	709	4702	750	STD	50	1460	1700	1935	2175	2415	2650				
										40	1460	1700	1935	2175	2415	2650				
										30	1565	1820	2075	2330	2585	2840				
										10 LT	1960	2280	2600	2920	3240	3555				
										10 HT	1565	1820	2075	2330	2585	2840				
										km/h - bar	0.6	0.8	1.0	1.2	1.4	1.6				

Performance



STD: Standard - SPL: Special





TRACTOR

AGRIMAX RT 855 (R-1W)

Ø 34"	Tire size	LI/SS	RIM		S.W. (mm)	O.D. (mm)	SLR (mm)	RC (mm)	SRI (index)	Version	Load capacity (kg/tire)											
			Rec.	Alt.							km/h - bar											
											0.6	0.8	1.0	1.2	1.4	1.6	2.0	2.4				
420/85 R 34 (16.9 R 34)	147 A8/B	W 15 L	W 13 ; W 14 L	438	1578	728	4782	750	STD	50	1450	1665	1910	2155	2400	2645	2895	3075				
										40	1450	1665	1910	2155	2400	2645	2895	3075				
										30	1550	1780	2045	2310	2575	2835	3100	3295				
										10 LT	1940	2230	2560	2890	3220	3550	3880	4125				
										10 HT	1550	1780	2045	2310	2575	2835	3100	3595				
420/85 R 34 (16.9 R 34)	142 A8/B	W 15 L	W 13 ; W 14 L	438	1578	709	4702	750	SPL	50	1460	1700	1935	2175	2415	2650	2840	3075				
										40	1460	1700	1935	2175	2415	2650	2840	3075				
										30	1565	1820	2075	2330	2585	2840	3075	3295				
										10 LT	1960	2280	2600	2920	3240	3555	3880	4125				
										10 HT	1565	1820	2075	2330	2585	2840	3075	3295				
460/85 R 34 (18.4 R 34)	147 A8/B	W 16 L	W 14 L ; W 15 L	475	1646	721	4865	775	STD	50	1695	1970	2245	2525	2800	3075	3295	3540				
										40	1695	1970	2245	2525	2800	3075	3295	3540				
										30	1815	2110	2410	2705	3000	3295	3540	3790				
										10 LT	2270	2640	3015	3385	3755	4125	4495	4865				
										10 HT	1815	2110	2410	2705	3000	3295	3540	3790				
460/85 R 34 (18.4 R 34)	158 A8/B	W 16 L	W 14 L ; W 15 L	475	1646	721	4865	775	STD	50	1660	1955	2255	2510	2805	3060	3360	3615	3955	4250		
										40	1660	1955	2255	2510	2805	3060	3360	3615	3955	4250		
										30	1755	2095	2415	2685	3005	3280	3595	3870	4235	4550		
										10 LT	2225	2620	3020	3365	3760	4105	4500	4845	5300	5695		
										10 HT	1900	2245	2585	2875	3215	3510	3850	4140	4530	4870		
460/85 R 34 (18.4 R 34)	147 A8/B	W 16 L	W 14 L ; W 15 L	475	1646	721	4865	775	SPL	50	1695	1970	2245	2525	2800	3075	3295	3540				
										40	1695	1970	2245	2525	2800	3075	3295	3540				
										30	1815	2110	2410	2705	3000	3295	3540	3790				
										10 LT	2270	2640	3015	3385	3755	4125	4495	4865				
										10 HT	1815	2110	2410	2705	3000	3295	3540	3790				
Ø 36"	320/85 R 36	147 D/ 150 A8	W 11	W 9 ; W 10	329	1458	672	4404	700	STD	65	1160	1330	1500	1810	2010	2120	2320	2515	2685	2825	3075
											50	1220	1400	1575	1905	2110	2230	2440	2645	2825	2970	3230
											40	1270	1455	1645	1985	2200	2325	2540	2755	2945	3095	3350
											30	1335	1530	1725	2080	2310	2440	2665	2895	3090	3250	3540
											10 LT	1555	1785	2010	2430	2695	2845	3110	3375	3605	3790	4125
	10 HT	1335	1530	1725	2080	2310	2440	2665	2895	3090	3250	3540										
	320/85 R 36 (12.4 R 36)	128 A8/B	W 11	W 9 ; W 10	329	1458	672	4404	700	STD	50	990	1155	1315	1585	1765	1930	2100	2245	2415	2595	2840
											40	990	1155	1315	1585	1765	1930	2100	2245	2415	2595	2840
											30	1065	1240	1410	1585	1765	1930	2100	2245	2415	2595	2840
											10 LT	1330	1550	1765	1985	2200	2415	2630	2845	3060	3275	3490
10 HT											1065	1240	1410	1585	1765	1930	2100	2245	2415	2595	2840	
320/85 R 36 (12.4 R 36)	128 A8/B	W 11	W 9 ; W 10	329	1458	672	4404	700	SPL	50	990	1155	1315	1585	1765	1930	2100	2245	2415	2595	2840	
										40	990	1155	1315	1585	1765	1930	2100	2245	2415	2595	2840	
										30	1065	1240	1410	1585	1765	1930	2100	2245	2415	2595	2840	
										10 LT	1330	1550	1765	1985	2200	2415	2630	2845	3060	3275	3490	
										10 HT	1065	1240	1410	1585	1765	1930	2100	2245	2415	2595	2840	
340/85 R 36 (13.6 R 36)	132 A8/B	W 12	W 11	353	1492	689	4507	725	STD	50	1100	1280	1460	1640	1820	2000	2180	2360	2540	2720	2900	
										40	1100	1280	1460	1640	1820	2000	2180	2360	2540	2720	2900	
										30	1180	1370	1565	1755	1950	2140	2330	2520	2710	2900	3090	
										10 LT	1475	1720	1960	2200	2440	2680	2920	3160	3400	3640	3880	
										10 HT	1180	1370	1565	1755	1950	2140	2330	2520	2710	2900	3090	

Performance



STD: Standard - SPL: Special





TRACTOR

AGRIMAX RT 855 (R-1W)

Ø 36"	Tire size	LI/SS	RIM		S.W. (mm)	O.D. (mm)	SLR (mm)	RC (mm)	SRI (index)	Version	Load capacity (kg/tire)									
			Rec.	Alt.							km/h - bar	0.6	0.8	1.0	1.2	1.4	1.6			
Ø 36"	340/85 R 36 (13.6 R 36)	132 A8/B	W 12	W 11	353	1492	689	4507	725	SPL	50	1100	1280	1460	1640	1820	2000			
											40	1100	1280	1460	1640	1820	2000			
											30	1180	1370	1565	1755	1950	2140			
											10 LT	1475	1720	1960	2200	2440	2680			
											10 HT	1180	1370	1565	1755	1950	2140			
Ø 38"	320/85 R 38 (12.4 R 38)	143 A8/B	W 11	W 9 ; W 10 ; DW 10 ; DW11	329	1509	700	4580	725	STD	50	985	1145	1500	1830	1990	2130	2320	2510	2725
											40	985	1145	1500	1830	1990	2130	2320	2510	2725
											30	1055	1230	1610	1960	2135	2280	2485	2690	2920
											10 LT	1320	1540	2015	2450	2670	2855	3110	3365	3655
											10 HT	1055	1230	1610	1960	2135	2280	2485	2690	2920
	320/85 R 38 (12.4 R 38)	143 A8/B	W 11	W 9 ; W 10 ; DW 10	329	1509	700	4580	725	SPL	50	985	1145	1500	1830	1990	2130	2320	2510	2725
											40	985	1145	1500	1830	1990	2130	2320	2510	2725
											30	1055	1230	1610	1960	2135	2280	2485	2690	2920
											10 LT	1320	1540	2015	2450	2670	2855	3110	3365	3655
											10 HT	1055	1230	1610	1960	2135	2280	2485	2690	2920
	340/85 R 38 (13.6 R 38)	133 A8/B	W 12	W 11	353	1543	712	4668	750	STD	50	1135	1320	1505	1690	1875	2060			
											40	1135	1320	1505	1690	1875	2060			
											30	1215	1415	1610	1810	2010	2205			
											10 LT	1525	1770	2020	2270	2520	2765			
											10 HT	1215	1415	1610	1810	2010	2205			
340/85 R 38 (13.6 R 38)	133 A8/B	W 12	W 11	353	1543	712	4668	750	SPL	50	1135	1320	1505	1690	1875	2060				
										40	1135	1320	1505	1690	1875	2060				
										30	1215	1415	1610	1810	2010	2205				
										10 LT	1525	1770	2020	2270	2520	2765				
										10 HT	1215	1415	1610	1810	2010	2205				
380/85 R 38 (14.9 R 38)	139 A8/B	W 12	W 11 ; W 13	380	1611	736	4842	775	STD	50	1340	1560	1775	1995	2215	2430				
										40	1340	1560	1775	1995	2215	2430				
										30	1435	1670	1905	2140	2375	2605				
										10 LT	1795	2090	2380	2675	2970	3260				
										10 HT	1435	1670	1905	2140	2375	2605				
380/85 R 38 (14.9 R 38)	139 A8/B	W 12	W 11 ; W 13	380	1611	736	4842	775	SPL	50	1340	1560	1775	1995	2215	2430				
										40	1340	1560	1775	1995	2215	2430				
										30	1435	1670	1905	2140	2375	2605				
										10 LT	1795	2090	2380	2675	2970	3260				
										10 HT	1435	1670	1905	2140	2375	2605				
420/85 R 38 (16.9 R 38)	144 A8/B	W 15 L	W 13 ; W 14 L	438	1679	763	5014	800	STD	50	1540	1795	2045	2300	2550	2800				
										40	1540	1795	2045	2300	2550	2800				
										30	1650	1920	2190	2460	2730	3000				
										10 LT	2070	2405	2745	3080	3420	3755				
										10 HT	1650	1920	2190	2460	2730	3000				
420/85 R 38 (16.9 R 38)	144 A8/B	W 15 L	W 13 ; W 14 L	438	1679	763	5014	800	SPL	50	1540	1795	2045	2300	2550	2800				
										40	1540	1795	2045	2300	2550	2800				
										30	1650	1920	2190	2460	2730	3000				
										10 LT	2070	2405	2745	3080	3420	3755				
										10 HT	1650	1920	2190	2460	2730	3000				

Performance



STD: Standard - SPL: Special





TRACTOR

AGRIMAX RT 855 (R-1W)

Ø 38"	Tire size	LI/SS	RIM		S.W. (mm)	O.D. (mm)	SLR (mm)	RC (mm)	SRI (index)	Version	Load capacity (kg/tire)								
			Rec.	Alt.							km/h - bar	0.6	0.8	1.0	1.2	1.4	1.6		
460/85 R 38 (18.4 R 38)	149 A8/B	W 16 L	W 14 L ; W 15 L	475	1747	785	5205	825	STD	50	1790	2080	2375	2665	2960	3250			
										40	1790	2080	2375	2665	2960	3250			
										30	1915	2230	2545	2855	3170	3480			
										10 LT	2400	2790	3180	3575	3965	4355			
										10 HT	1915	2230	2545	2855	3170	3480			
460/85 R 38 (18.4 R 38)	149 A8/B	W 16 L	W 14 L ; W 15 L	475	1747	785	5205	825	SPL	50	1790	2080	2375	2665	2960	3250			
										40	1790	2080	2375	2665	2960	3250			
										30	1915	2230	2545	2855	3170	3480			
										10 LT	2400	2790	3180	3575	3965	4355			
										10 HT	1915	2230	2545	2855	3170	3480			
480/80 R 38 (18.4 R 38)	149 A8/B	DW 16 L	W 14 L ; W 15 L	475	1747	785	5161	825	STD	50	1790	2080	2375	2665	2960	3250			
										40	1790	2080	2375	2665	2960	3250			
										30	1915	2230	2545	2855	3170	3480			
										10 LT	2400	2790	3180	3575	3965	4355			
										10 HT	1915	2230	2545	2855	3170	3480			
520/85 R 38 (20.8 R 38)	155 A8/B	DW 16 L	DW 18 L ; DD 16 L	516	1849	813	5466	875	STD	50	2170	2560	2910	3255	3565	3875			
										40	2170	2560	2910	3255	3565	3875			
										30	2325	2740	3115	3490	3820	4150			
										10 LT	2910	3430	3900	4365	4780	5195			
										10 HT	2325	2740	3115	3490	3820	4150			
520/85 R 38 (20.8 R 38)	170 A8/B	DW 16 L	DW 18 L ; DD 16 L	516	1849	847	5595	875	STD	50	2170	2560	3255	3875	4440	4740	5220	5640	6000
										40	2170	2560	3255	3875	4440	4740	5220	5640	6000
										30	2325	2740	3490	4150	4755	5075	5590	6035	6420
										10 LT	2910	3430	4365	5195	5950	6355	6995	7560	8040
										10 HT	2325	2740	3490	4150	4755	5075	5590	6035	6420
520/85 R 38	170 A8/B	DW 16 L	DW 18 L ; DD 16 L	516	1849	847	5595	875	SPL	50	2170	2650	3255	3875	4440	4740	5220	5640	6000
										40	2170	2650	3255	3875	4440	4740	5220	5640	6000
										30	2325	2740	3490	4150	4755	5075	5590	6035	6420
										10 LT	2910	3430	4365	5195	5950	6355	6995	7560	8040
										10 HT	2325	2740	3490	4150	4755	5075	5590	6035	6420
520/85 R 38 (20.8 R 38)	155 A8/B	DW 16 L	DW 18 L ; DD 16 L	516	1849	813	5466	875	SPL	50	2170	2560	2910	3255	3565	3875			
										40	2170	2560	2910	3255	3565	3875			
										30	2325	2740	3115	3490	3820	4150			
										10 LT	2910	3430	3900	4365	4780	5195			
										10 HT	2325	2740	3115	3490	3820	4150			
Ø 42"	480/80 R 42 (18.4 R 42)	151 A8/B	W 16 A ; DD 16 ; DW 16 A	DD 16 L ; DW 16 L ; W 16 L	479	1835	835	5495	875	STD	50	1900	2210	2520	2830	3140	3450		
											40	1900	2210	2520	2830	3140	3450		
											30	2035	2365	2700	3030	3365	3695		
											10 LT	2545	2960	3380	3795	4210	4625		
											10 HT	2035	2365	2700	3030	3365	3695		

STD: Standard - SPL: Special

Performance





TRACTOR

AGRIMAX RT 855 (R-1W)

Ø 42"	Tire size	LI/SS	RIM		S.W. (mm)	O.D. (mm)	SLR (mm)	RC (mm)	SRI (index)	Version	Load capacity (kg/tire)																
			Rec.	Alt.							km/h - bar	0.6	0.8	1.0	1.2	1.4	1.6										
											50	40	30	10 LT	10 HT	50	40	30	10 LT	10 HT	50	40	30	10 LT	10 HT		
520/85 R 42 (20.8 R 42)	157 A8/B	DW 16 L; W 16 A; DD 16	DW 18 A; DD 18; W 18 A; DD 18 L	516	1951	858	5782	925	STD	km/h - bar	0.6	0.8	1.0	1.2	1.4	1.6											
										50	2270	2640	3015	3385	3755	4125											
										40	2270	2640	3015	3385	3755	4125											
										30	2430	2830	3225	3625	4020	4415											
										10 LT	3045	3540	4040	4535	5035	5530											
10 HT	2430	2830	3225	3625	4020	4415																					
520/85 R 42 (20.8 R 42)	167 A8/B	DW 16 L; W 16 A; DD 16	DW 18 A; DD 18; W 18 A; DD 18 L	516	1951	858	5782	925	STD	km/h - bar	0.6	0.8	1.0	1.2	1.4	1.6	2.4	2.8	3.2								
										50	2270	2640	3015	3385	3755	4125	4635	5070	5450								
										40	2270	2640	3015	3385	3755	4125	4635	5070	5450								
										30	2430	2830	3225	3625	4020	4415	4960	5425	5830								
										10 LT	3045	3540	4040	4535	5035	5530	6210	6795	7305								
10 HT	2430	2830	3225	3625	4020	4415	4960	5425	5830																		
520/85 R 42 (20.8 R 42)	157 A8/B	DW 16 L; W 16 A; DD 16	DW 18 A; DD 18; W 18 A; DD 18 L	516	1951	858	5782	925	SPL	km/h - bar	0.6	0.8	1.0	1.2	1.4	1.6											
										50	2270	2640	3015	3385	3755	4125											
										40	2270	2640	3015	3385	3755	4125											
										30	2430	2830	3225	3625	4020	4415											
										10 LT	3045	3540	4040	4535	5035	5530	6210	6795	7305								
10 HT	2430	2830	3225	3625	4020	4415	4960	5425	5830																		
520/85 R 42 (20.8 R 42)	167 A8/B	DW 16 L; W 16 A; DD 16	DW 18 A; DD 18; W 18 A; DD 18 L	516	1951	858	5782	925	SPL	km/h - bar	0.6	0.8	1.0	1.2	1.4	1.6	2.4	2.8	3.2								
										50	2270	2640	3015	3385	3755	4125	4635	5070	5450								
										40	2270	2640	3015	3385	3755	4125	4635	5070	5450								
										30	2430	2830	3225	3625	4020	4415	4960	5425	5830								
										10 LT	3045	3540	4040	4535	5035	5530	6210	6795	7305								
10 HT	2430	2830	3225	3625	4020	4415	4960	5425	5830																		
Ø 46"	420/80 R 46 (16.9 R 46)	159 D/ 170 A2	W 13	W 12	418	1840	863	5641	900	STD	km/h - bar	0.6	0.8	1.0	1.2	1.4	1.6	2.0	2.4								
											65	1625	1865	2140	2415	2695	2970	3210	3450								
											50	1705	1960	2250	2540	2830	3120	3375	3625								
											40	1780	2045	2345	2650	2950	3255	3520	3780								
											30	1870	2145	2465	2780	3100	3415	3695	3970								
	10	2235	2565	2945	3325	3705	4085	4420	4750																		
	10 LT	2175	2500	2870	3240	3610	3980	4305	4625																		
	10 HT	1870	2145	2465	2780	3100	3415	3695	3970																		
	420/80 R 46 (16.9 R 46)	151 D/ 162 A2	W 13	W 12	418	1840	863	5641	900	STD	km/h - bar	0.6	0.8	1.0	1.2	1.4	1.6	2.0	2.4								
											65	1625	1865	2140	2415	2695	2970	3210	3450								
50											1705	1960	2250	2540	2830	3120	3375	3625									
40											1780	2045	2345	2650	2950	3255	3520	3780									
30											1870	2145	2465	2780	3100	3415	3695	3970									
10	2235	2565	2945	3325	3705	4085	4420	4750																			
10 LT	2175	2500	2870	3240	3610	3980	4305	4625																			
10 HT	1870	2145	2465	2780	3100	3415	3695	3970																			
420/80 R 46 (16.9 R 46)	159 D/ 170 A2	W 13	W 12	418	1840	863	5641	900	SPL	km/h - bar	0.6	0.8	1.0	1.2	1.4	1.6	2.0	2.4	2.8	3.2							
										65	1625	1865	2140	2415	2695	2970	3210	3450	4070	4375							
										50	1705	1960	2250	2540	2830	3120	3375	3625	4275	4595							
										40	1780	2045	2345	2650	2950	3255	3520	3780	4460	4795							
										30	1870	2145	2465	2780	3100	3415	3695	3970	4685	5035							
10	2235	2565	2945	3325	3705	4085	4420	4750	5580	6000																	
10 LT	2175	2500	2870	3240	3610	3980	4305	4625	5455	5865																	
10 HT	1870	2145	2465	2780	3100	3415	3695	3970	4685	5035																	

STD: Standard - SPL: Special

Performance





TRACTOR

AGRIMAX RT 855 (R-1W)

Ø 46"	Tire size	LI/SS	RIM		S.W. (mm)	O.D. (mm)	SLR (mm)	RC (mm)	SRI (index)	Version	Load capacity (kg/tire)													
			Rec.	Alt.																				
											km/h - bar	0.6	0.8	1.0	1.2	1.4	1.6	2.0	2.4					
480/80 R 46 (18.4 R 46)	158 A8/B	DW 16 A ; W 16 A ; DD 16	W 16 L ; DD 16 L ; DW 16 L	479	1936	895	5871	925	STD	50	2000	2295	2635	2975	3315	3655	3955	4250						
										40	2000	2295	2635	2975	3315	3655	3955	4250						
										30	2140	2460	2825	3185	3550	3915	4235	4550						
										10 LT	2680	3080	3535	3990	4445	4900	5300	5695						
										10 HT	2140	2460	2825	3185	3550	3915	4235	4550						
480/80 R 46 (18.4 R 46)	164 A8/B	DW 16 A ; W 16 A ; DD 16	W 16 L ; DD 16 L ; DW 16 L	479	1936	895	5871	925	STD	km/h - bar	0.8	1.0	1.2	1.4	1.6	2.0	2.4	2.8	3.2					
										50	2295	2635	2975	3315	3655	3955	4250	4650	5000					
										40	2295	2635	2975	3315	3655	3955	4250	4650	5000					
										30	2460	2825	3185	3550	3915	4235	4550	4975	5350					
										10 LT	3080	3535	3990	4445	4900	5300	5695	6230	6700					
10 HT	2460	2825	3185	3550	3915	4235	4550	4975	5350															
520/85 R 46 (20.8 R 46)	158 A8/B	DW 16 L ; W 16 A ; W 16 L ; DD 16	DW 18 L ; W 18 L ; W 18 A	516	2052	930	6157	975	STD	km/h - bar	0.6	0.8	1.0	1.2	1.4	1.6								
										50	2340	2720	3105	3485	3870	4250								
										40	2340	2720	3105	3485	3870	4250								
										30	2505	2915	3325	3735	4145	4550								
										10 LT	3135	3645	4160	4670	5185	5695								
10 HT	2505	2915	3325	3735	4145	4550																		
520/85 R 46 (20.8 R 46)	173 A8/B	DW 16 L ; W 16 A ; W 16 L ; DD 16	DW 18 L ; W 18 L ; W 18 A	516	2052	964	6310	975	STD	km/h - bar	0.6	0.8	1.0	1.2	1.4	1.6	2.4	2.8	3.2	3.6	4.0			
										50	2340	2720	3105	3485	3870	4250	4875	5330	5785	6175	6500			
										40	2340	2720	3105	3485	3870	4250	4875	5330	5785	6175	6500			
										30	2505	2915	3325	3735	4145	4550	5215	5705	6190	6605	6955			
										10 LT	3135	3645	4160	4670	5185	5695	6535	7140	7750	8275	8710			
10 HT	2505	2915	3325	3735	4145	4550	5215	5705	6190	6605	6955													
520/85 R 46 (20.8 R 46)	158 A8/B	DW 16 L ; W 16 A ; W 16 L ; DD 16	DW 18 L ; W 18 L ; W 18 A	516	2052	930	6157	975	SPL	km/h - bar	0.6	0.8	1.0	1.2	1.4	1.6								
										50	2340	2720	3105	3485	3870	4250								
										40	2340	2720	3105	3485	3870	4250								
										30	2505	2915	3325	3735	4145	4550								
										10 LT	3135	3645	4160	4670	5185	5695								
10 HT	2505	2915	3325	3735	4145	4550																		
Ø 50"	480/80 R 50 (18.4 R 50)	159 A8/B	DW 16 L	DW 15 L ; W 15 L	489	2036	941	6183	975	STD	km/h - bar	0.6	0.8	1.0	1.2	1.4	1.6	2.0	2.4					
											50	2060	2365	2715	3065	3415	3765	4070	4375					
											40	2060	2365	2715	3065	3415	3765	4070	4375					
											30	2205	2530	2905	3280	3655	4030	4360	4685					
											10 LT	2760	3170	3640	4110	4575	5045	5455	5865					
10 HT	2205	2530	2905	3280	3655	4030	4360	4685																
480/80 R 50 (18.4 R 50)	176 A8	DW 16 L	DW 15 L ; W 15 L	489	2036	945	6183	975	SB	km/h - bar	0.6	0.8	1.0	1.2	1.4	1.6	2.0	2.4	2.8	3.2	3.6	4.0	4.4	5.0
										50	2060	2365	2715	3065	3415	3765	4070	4375	4760	5185	5470	5825	6320	7100
										40	2060	2365	2715	3065	3415	3765	4070	4375	4760	5185	5470	5825	6320	7100
										30	2205	2530	2905	3280	3655	4030	4360	4685	5095	5550	5855	6235	6765	7600
										10 LT	2760	3170	3640	4110	4575	5045	5455	5865	6380	6950	7330	7805	8470	9515
10 HT	2205	2530	2905	3280	3655	4030	4360	4685	5095	5550	5855	6235	6765	7600										
520/85 R 50 (20.8 R 50)	165 A8/B	DW 16 L	DW 18 L	516	2154	992	6472	1025	STD	km/h - bar	0.6	0.8	1.0	1.2	1.4	1.6	2.0	2.4						
										50	2425	2785	3195	3605	4020	4430	4845	5150						
										40	2425	2785	3195	3605	4020	4430	4845	5150						
										30	2595	2980	3420	3865	4305	4745	5185	5515						
										10 LT	3250	3730	4285	4835	5390	5940	6495	6905						
10 HT	2595	2980	3420	3865	4305	4745	5185	5515																

STD: Standard - SPL: Special - SB: Steel Belted

Performance





TRACTOR

Radial



AGRIMAX RT 945 (R-1W)

AGRIMAX RT 945 is specially designed for row crops: it does not damage the crops and preserves the yield. Excellent self-cleaning features allow for a quick change from field operations to road usage, where AGRIMAX RT 945 shows brilliant performance. Its strong carcass gives the tire excellent stability, outstanding traction, and exceptional durability.

Ø 30"	Tire size	LI/SS	RIM		S.W. (mm)	O.D. (mm)	SLR (mm)	RC (mm)	SRI (index)	Version	Load capacity (kg/tire)										
			Rec.	Alt.							km/h - bar	0.8	1.2	1.6	2.0	2.4					
Ø 30"	420/90 R 30	147 A8/B	DW 13	W 14 L	418	1518	684	4571	725	STD	50	1665	2155	2645	2895	3075					
											40	1665	2155	2645	2895	3075					
											30	1780	2310	2835	3100	3295					
											10	2495	3235	3970	4340	4615					
Ø 42"	320/90 R 42 (12.4 R 42)	139 A8/B	W 10	W 9 ; W 11	319	1643	760	4944	800	STD	50	1315	1705	2090	2260	2430	-				
											40	1315	1705	2090	2260	2430	-				
											30	1410	1825	2245	2425	2605	-				
											10	1935	2370	2880	3355	3540	3645				
Ø 46"	320/90 R 46	148 D/ 151 A8	W 10	W 9 ; W 11	319	1744	810	5232	850	STD	65	1355	1765	2145	2365	2490	2745	2965	3150		
											50	1425	1855	2255	2485	2615	2880	3115	3310		
											40	1485	1935	2350	2590	2730	3005	3245	3450		
											30	1560	2030	2465	2715	2860	3150	3405	3620		
											10	2035	2650	3215	3545	3735	4115	4445	4725		
	320/90 R 46 (12.4 R 46)	146 A8/B	W 10	W 9 ; W 11	319	1744	810	5232	850	STD	50	1380	1770	2160	2370	2550	2790	3000	-		
											40	1380	1770	2160	2370	2550	2790	3000	-		
											30	1480	1895	2315	2540	2730	2990	3210	-		
											10	1620	2115	2565	3060	3510	3645	4050	4500		
	380/90 R 46 (14.9 R 46)	155 A8/B	W 12	W 11 ; W 13	380	1852	866	5648	900	STD	50	1785	2290	2790	3065	3295	3605	3875	-		
											40	1785	2290	2790	3065	3295	3605	3875	-		
											30	1910	2450	2990	3280	3530	3860	4150	-		
											10	2095	2735	3315	3955	4540	4715	5235	5815		
	380/90 R 46 (14.9 R 46)	159 A8/B	W 12	W 11 ; W 13	380	1852	859	5699	900	STD	50	1785	2290	2790	3065	3295	3605	3875	4070	4375	-
											40	1785	2290	2790	3065	3295	3605	3875	4070	4375	-
30											1910	2450	2990	3280	3530	3860	4150	4360	4685	-	
10											2095	2735	3315	3955	4540	4715	5235	5815	6040	6565	
Ø 50"	320/90 R 50 (12.4 R 50)	150 A8/B	W 10	W 9 ; W 11	319	1846	873	5618	900	STD	50	1410	1845	2245	2450	2615	2850	3085	3350	-	
											40	1410	1845	2245	2450	2615	2850	3085	3350	-	
											30	1510	1975	2405	2620	2800	3050	3300	3585	-	
											10	1960	2565	3120	3420	3620	3970	4325	4675	5025	

STD: Standard

Technologies



Strong Casing

Performance



Durability



High Load Capacity



Self-Cleaning



Stability



Traction



AGRIMAX RT 945 (R-1W)

Ø 50"	Tire size	LI/SS	RIM		S.W. (mm)	O.D. (mm)	SLR (mm)	RC (mm)	SRI (index)	Version	Load capacity (kg/tire)											
			Rec.	Alt.							km/h - bar	0.8	1.2	1.6	2.0	2.4	2.8					
380/90 R 50 (14.9 R 50)	151 A8/B	W 12	W 11; W 13	380	1954	906	5900	950	STD	50	1865	2415	2970	3210	3450	-						
										40	1865	2415	2970	3210	3450	-						
										30	2000	2590	3180	3440	3695	-						
										10	2745	3365	4090	4765	5020	5175						
										km/h - bar	0.8	1.2	1.6	2.0	2.4	2.8	3.2	3.6	4.0	4.4		
380/90 R 50 (14.9 R 50)	160 A8/B	W 12	W 11; W 13	390	1954	921	5958	950	STD	50	1845	2385	2880	3195	3375	3690	4005	4275	4500	-		
										40	1845	2385	2880	3195	3375	3690	4005	4275	4500	-		
										30	1975	2555	3085	3420	3615	3950	4290	4575	4815	-		
										10	2670	3450	4165	4620	4880	5335	5790	6180	6505	6750		
										km/h - bar	0.8	1.2	1.6	2.0	2.4	2.8	3.2	3.6	4.0	4.4		
Ø 54"	320/90 R 54 (12.4 R 54)	156 A8/B	W 10	W 9; W 11	319	1948	930	6021	950	STD	50	1500	1935	2340	2595	2740	2995	3250	3470	3650	4000	-
											40	1500	1935	2340	2595	2740	2955	3250	3470	3650	4000	-
											30	1605	2075	2505	2780	2935	3210	3480	3715	3910	4280	-
											10	-	1860	2340	2880	3420	3960	4080	4560	5040	5520	6000
											km/h - bar	0.8	1.2	1.6	2.0	2.4	2.8	3.2	3.6	4.0	4.4	4.8
380/90 R 54 (14.9 R 54)	158 A8/B	W 12	W 11; W 13	380	2056	962	6232	1000	STD	50	1955	2510	3060	3315	3615	3955	4250	-				
										40	1955	2510	3060	3315	3615	3955	4250	-				
										30	2095	2685	3280	3550	3870	4235	4550	-				
										10	2295	3000	3635	4335	4975	5165	5740	-				
										km/h - bar	0.8	1.2	1.6	2.0	2.4	2.8	3.2	3.6				

STD: Standard

Technologies



Strong Casing

Performance



Durability



High Load Capacity



Self-Cleaning



Stability



Traction





TRACTOR

Radial



AGRIMAX ELOS (R-2)

AGRIMAX ELOS has been designed to enhance top traction performance even under particularly awkward operating conditions on wet terrains such as paddy fields or marshland. The tread design has been especially developed to ensure optimum self-cleaning properties, which are essential for operations on muddy land and during transfers. To optimize the farmers' productivity reducing machine downtime, sidewall protectors have been integrated into the design of the AGRIMAX ELOS tire to ensure maximum protection against possible damages at any time.

AGRIMAX ELOS
RADIAL MARSHLAND TIRES

Ø 28"	Tire size	LI/SS	RIM		S.W. (mm)	O.D. (mm)	SLR (mm)	RC (mm)	SRI (index)	Version	Load capacity (kg/tire)										
			Rec.	Alt.							km/h - bar	0.6	0.8	1.0	1.2	1.4	1.6				
420/85 R 28 (16.9 R 28)	139 A8/B	W 15 L	W 13 ; W 14 L	438	1467	665	4349	700	STD	50	1340	1560	1775	1995	2215	2430					
										40	1340	1560	1775	1995	2215	2430					
										30	1435	1670	1905	2140	2375	2605					
										10 LT	1795	2090	2380	2675	2970	3260					
										10 HT	1435	1670	1905	2140	2375	2605					
Ø 34"	480/70 R 34	155 A8/ 155 B	W 15 L	W 16 L ; W 14 L	500	1605	733	4868	750	STD	km/h - bar	0.6	0.8	1.0	1.2	1.4	1.6	2.0	2.4	2.8	3.2
											50	1515	1785	2055	2290	2560	2790	3065	3375	3645	3875
											40	1515	1785	2055	2290	2560	2790	3065	3375	3645	3875
											30	1620	1910	2200	2450	2740	2990	3280	3615	3905	4150
											10 LT	2030	2390	2755	3070	3430	3745	4105	4520	4885	5195
											10 HT	1620	1910	2200	2450	2740	2990	3280	3615	3905	4150
Ø 38"	340/85 R 38 (13.6 R 38)	133 A8/B	W 12	W 11	353	1602	735	4774	775	STD	km/h - bar	0.6	0.8	1.0	1.2	1.4	1.6				
											50	1135	1320	1505	1690	1875	2060				
											40	1135	1320	1505	1690	1875	2060				
											30	1215	1415	1610	1810	2010	2205				
											10 LT	1525	1770	2020	2270	2520	2765				
											10 HT	1215	1415	1610	1810	2010	2205				
380/85 R 38 (14.9 R 38)	139 A8/B	W 12	W 11 ; W 13	380	1662	772	4994	775	STD	km/h - bar	0.6	0.8	1.0	1.2	1.4	1.6					
										50	1340	1560	1775	1995	2215	2430					
										40	1340	1560	1775	1995	2215	2430					
										30	1435	1670	1905	2140	2375	2605					
										10 LT	1795	2090	2380	2675	2970	3260					
										10 HT	1435	1670	1905	2140	2375	2605					
420/85 R 38 (16.9 R 38)	144 A8/B	W 15 L	W 13 ; W 14 L	438	1735	785	5135	825	STD	km/h - bar	0.6	0.8	1.0	1.2	1.4	1.6					
										50	1540	1795	2045	2300	2550	2800					
										40	1540	1795	2045	2300	2550	2800					
										30	1650	1920	2190	2460	2730	3000					
										10 LT	2070	2405	2745	3080	3420	3755					
										10 HT	1650	1920	2190	2460	2730	3000					
480/80 R 38 (18.4 R 38)	149 A8/B	W 16 L	W 15 L ; DW 16 L	489	1803	821	5356	825	STD	km/h - bar	0.6	0.8	1.0	1.2	1.4	1.6					
										50	1790	2080	2375	2665	2960	3250					
										40	1790	2080	2375	2665	2960	3250					
										30	1915	2230	2545	2855	3170	3480					
										10 LT	2400	2790	3180	3575	3965	4355					
										10 HT	1915	2230	2545	2855	3170	3480					
710/70 R 38	178 A8/B	DW 23 B	DW 25 B	716	2019	915	6103	925	STD	km/h - bar	0.6	0.8	1.0	1.2	1.4	1.6	2.0	2.4	2.8	3.2	3.6
										50	2775	3225	3675	4200	4650	5100	5625	5925	6525	7050	7500
										40	2775	3225	3675	4200	4650	5100	5625	5925	6525	7050	7500
										30	2970	3455	3935	4495	4980	5460	6020	6340	6985	7545	8025
										10 LT	3720	4325	4925	5630	6235	6835	7540	7940	8745	9450	10050
										10 HT	2970	3455	3935	4495	4980	5460	6020	6340	6985	7545	8025

STD: Standard

Technologies



Extra Deep Tread

Performance



For muddy ground



Self-Cleaning



Traction





TRACTOR

AGRIMAX ELOS (R-2)

Ø 42"	Tire size	LI/SS	RIM		S.W. (mm)	O.D. (mm)	SLR (mm)	RC (mm)	SRI (index)	Version	Load capacity (kg/tire)										
			Rec.	Alt.																	
											km/h - bar	0.6	0.8	1.0	1.2	1.4	1.6				
480/80 R 42 (18.4 R 42)	151 A8/B	DW 16 L	DD 16 L ; W 16 L	489	1890	857	5629	875	STD	50	1900	2210	2520	2830	3140	3450					
										40	1900	2210	2520	2830	3140	3450					
										30	2035	2365	2700	3030	3365	3695					
										10 LT	2545	2960	3380	3795	4210	4625					
										10 HT	2035	2365	2700	3030	3365	3695					
520/85 R 42 (20.8 R 42)	157 A8/B	DW 16 L	DD 18 L ; DW 18 L	516	1988	904	5865	925	STD	50	2270	2640	3015	3385	3755	4125					
										40	2270	2640	3015	3385	3755	4125					
										30	2430	2830	3225	3625	4020	4415					
										10 LT	3045	3540	4040	4535	5035	5530					
										10 HT	2430	2830	3225	3625	4020	4415					
Ø 46"	520/85 R 46	169 A8/ 169 B	DW 16 L	DW 15 L ; DW 18 L ; W 15 L ; W 16 L ; W 18 L ; DD 16 L ; DD 18 L	530	2075	957	6293	975	STD	50	2265	2670	3075	3425	3830	4180	4585	5050	5455	5800
											40	2265	2670	3075	3425	3830	4180	4585	5050	5455	5800
											30	2425	2860	3295	3665	4100	4475	4910	5405	5840	6210
											10 LT	3035	3580	4125	4590	5135	5600	6145	6765	7310	7775
											10 HT	2425	2860	3295	3665	4100	4475	4910	5405	5840	6210

STD: Standard

Technologies



Extra Deep Tread

Performance



For muddy ground



Self-Cleaning



Traction





TRACTOR

Radial



AGRIMAX RT 955 (R-1)

AGRIMAX RT 955 is a BKT radial tire for row crop applications, while some sizes are also suitable for spraying and vineyards. The special tread design with a rounded shoulder provides excellent traction performance, stability and self-cleaning properties. Thanks to its strong casing, AGRIMAX RT 955 has a high load capacity.

Ø 24"	Tire size	LI/SS	RIM		S.W. (mm)	O.D. (mm)	SLR (mm)	RC (mm)	SRI (index)	Version	Load capacity (kg/tire)												
			Rec.	Alt.							km/h - bar	0.6	0.8	1.0	1.2	1.4	1.6	2.0	2.4	2.8			
210/90 R 24 (8.3 R 24)	107 A8/B	W 7	W 6	214	1010	462	3027	475	STD	50	460	530	605	685	765	840	910	975	-	-			
										40	460	530	605	685	765	840	910	975	-	-			
										30	495	565	650	735	820	900	975	1045	-	-			
										10	675	780	865	955	1055	1160	1350	1425	1465	-	-		
210/95 R 28 (8.3 R 28)	116 A8/B	W 7	W 6	214	1111	513	3364	550	STD	50	590	675	775	875	975	1075	1165	1250	-	-			
										40	590	675	775	875	975	1075	1165	1250	-	-			
										30	630	725	835	940	1050	1155	1250	1340	-	-			
										10	865	995	1110	1220	1350	1485	1725	1820	1875	-	-		
210/95 R 32 (8.3 R 32)	120 A8/B	W 7	W 6	214	1213	571	3703	575	STD	50	645	830	1010	1095	1190	1305	1400	-	-				
										40	645	830	1010	1095	1190	1305	1400	-	-				
										30	690	885	1080	1170	1275	1395	1500	-	-				
										10	905	1180	1430	1555	1660	1830	1975	2100	-	-			
	230/95 R 32 (9.5 R 32)	128 A8/B	W 7	W 8	228	1251	585	3810	600	STD	50	705	920	1120	1225	1300	1425	1550	1675	1800	-		
											40	705	920	1120	1225	1300	1425	1550	1675	1800	-		
											30	755	985	1200	1315	1390	1525	1660	1795	1930	-		
											10	840	1055	1300	1540	1785	1840	2055	2270	2485	2700	-	
	270/95 R 32 (11.2 R 32)	136 A8/B	W 9	W 8 ; W 10	275	1327	614	4076	625	STD	50	875	1145	1390	1525	1615	1770	1930	2085	2240	-		
											40	875	1145	1390	1525	1615	1770	1930	2085	2240	-		
											30	940	1225	1490	1635	1730	1900	2065	2235	2400	-		
											10	1045	1315	1615	1920	2220	2285	2555	2825	3095	3360	-	
230/95 R 36 (9.5 R 36)	130 A8/B	W 8	W 7	238	1352	639	4112	650	STD	50	745	970	1180	1295	1370	1505	1635	1770	1900	-			
										40	745	970	1180	1295	1370	1505	1635	1770	1900	-			
										30	795	1040	1265	1385	1470	1610	1755	1895	2035	-			
										10	885	1115	1370	1625	1885	1940	2170	2395	2625	2850	-		
	270/80 R 36	134 A8/B	W 9	W 8 ; W 10	275	1346	629	4090	650	STD	50	745	870	1000	1125	1255	1360	1510	1590	1740	1890	2015	2120
											40	745	870	1000	1125	1255	1360	1510	1590	1740	1890	2015	2120
											30	795	935	1070	1205	1340	1455	1615	1705	1865	2025	2160	2270
											10	1115	1305	1495	1690	1880	2040	2260	2385	2610	2835	3025	3180
	270/95 R 36 (11.2 R 36)	139 A8/B	W 9	W 8 ; W 10	275	1428	665	4335	675	STD	50	950	1240	1510	1655	1750	1920	2090	2260	2430	-		
											40	950	1240	1510	1655	1750	1920	2090	2260	2430	-		
											30	1020	1330	1620	1775	1880	2060	2245	2425	2605	-		
											10	1130	1425	1750	2080	2410	2480	2775	3065	3355	3645	-	

STD: Standard

Technologies



Strong Casing

Performance



Durability



High Load Capacity



Self-Cleaning



Stability



Traction





TRACTOR

AGRIMAX RT 955 (R-1)

Ø 38"	Tire size	LI/SS	RIM		S.W. (mm)	O.D. (mm)	SLR (mm)	RC (mm)	SRI (index)	Version	Load capacity (kg/tire)													
			Rec.	Alt.							km/h - bar	0.8	1.2	1.6	2.0	2.4	2.8	3.2	3.6	4.0	4.4			
Ø 38"	270/95 R 38 (11.2 R 38)	140 A8/B	W 9	W 8 ; W 10	275	1479	697	4510	700	STD	km/h - bar	0.8	1.2	1.6	2.0	2.4	2.8	3.2	3.6	4.0	4.4			
											50	975	1275	1550	1700	1800	1975	2150	2325	2500	-			
											40	975	1275	1550	1700	1800	1975	2150	2325	2500	-			
											30	1045	1365	1660	1820	1930	2115	2305	2490	2675	-			
10	1165	1465	1800	2140	2475	2550	2850	3150	3450	3750	-													
Ø 40"	230/95 R 40 (9.5 R 40)	132 A8/B	W 7	W 8	228	1454	690	4445	700	STD	km/h - bar	0.8	1.2	1.6	2.0	2.4	2.8	3.2	3.6	4.0	4.4			
											50	820	1060	1280	1420	1500	1640	1780	1900	2000	-			
											40	820	1060	1280	1420	1500	1640	1780	1900	2000	-			
											30	880	1135	1370	1520	1605	1755	1905	2035	2140	-			
10	930	1170	1440	1710	1980	2040	2280	2520	2760	3000	-													
Ø 42"	230/95 R 42 (9.5 R 42)	133 A8/B	W 8	W 7	238	1506	714	4595	725	STD	km/h - bar	0.8	1.2	1.6	2.0	2.4	2.8	3.2	3.6	4.0	4.4			
											50	805	1055	1280	1405	1485	1630	1775	1920	2060	-			
											40	805	1055	1280	1405	1485	1630	1775	1920	2060	-			
											30	860	1125	1370	1500	1590	1745	1900	2055	2205	-			
	10	960	1210	1485	1765	2040	2105	2350	2600	2845	3090	-												
	300/85 R 42 (11.2 R 42)	144 A8/B	W 9	W 10 ; W 11	295	1577	745	4850	750	STD	km/h - bar	0.8	1.2	1.6	2.0	2.4	2.8	3.2	3.6	4.0	4.4			
											50	1150	1485	1795	1960	2100	2300	2495	2660	2800	-			
											40	1150	1485	1795	1960	2100	2300	2495	2660	2800	-			
30											1230	1590	1920	2100	2250	2460	2670	2850	3000	-				
10	1305	1640	2020	2395	2775	2860	3195	3530	3865	4200	-													
Ø 44"	210/95 R 44 (8.3 R 44)	120 A8/B	W 7	W 6	214	1518	721	4653	725	STD	km/h - bar	0.6	0.8	1.0	1.2	1.4	1.6	2.0	2.4	2.8				
											50	660	760	870	980	1095	1205	1305	1400	-				
											40	660	760	870	980	1095	1205	1305	1400	-				
											30	705	810	930	1050	1170	1290	1395	1500	-				
	10	970	1115	1240	1365	1515	1660	1935	2040	2100	-													
	230/95 R 44 (9.5 R 44)	134 A8/B	W 8	W 7	238	1556	739	4788	750	STD	km/h - bar	0.8	1.2	1.6	2.0	2.4	2.8	3.2	3.6	4.0	4.4			
											50	830	1085	1315	1445	1530	1675	1825	1975	2120	-			
											40	830	1085	1315	1445	1530	1675	1825	1975	2120	-			
											30	890	1160	1410	1545	1635	1795	1955	2115	2270	-			
	10	990	1245	1530	1815	2100	2165	2420	2675	2930	3180	-												
	270/95 R 44 (11.2 R 44)	142 A8/B	W 9	W 8 ; W 10	275	1632	764	4983	775	STD	km/h - bar	0.8	1.2	1.6	2.0	2.4	2.8	3.2	3.6	4.0	4.4			
											50	1035	1355	1645	1805	1910	2095	2280	2465	2650	-			
40											1035	1355	1645	1805	1910	2095	2280	2465	2650	-				
30											1110	1450	1765	1935	2045	2245	2445	2645	2840	-				
10	1235	1555	1910	2270	2625	2705	3025	3340	3660	3975	-													
Ø 46"	270/95 R 46 (11.2 R 46)	143 A8/B	W 9	W 8 ; W 10	275	1683	792	5169	825	STD	km/h - bar	0.8	1.2	1.6	2.0	2.4	2.8	3.2	3.6	4.0	4.4			
											50	1120	1445	1745	1910	2045	2235	2430	2590	2725	-			
											40	1120	1445	1745	1910	2045	2235	2430	2590	2725	-			
											30	1200	1550	1870	2045	2190	2395	2600	2775	2920	-			
	10	1545	2000	2410	2640	2825	3090	3355	3580	3765	4090	-												
	300/95 R 46 (12.4 R 46)	148 A8/B	W 9	W 10 ; W 11 ; DW 10 ; DW 11	295	1738	812	5318	850	STD	km/h - bar	0.6	0.8	1.0	1.2	1.4	1.6	2.0	2.4	2.8	3.2	3.6	4.0	4.4
											50	1105	1295	1485	1670	1860	2020	2205	2365	2585	2805	2995	3150	-
											40	1105	1295	1485	1670	1860	2020	2205	2365	2585	2805	2995	3150	-
											30	1185	1385	1590	1790	1995	2160	2365	2535	2770	3005	3210	3375	-
											20	1360	1590	1825	2055	2290	2480	2715	2910	3180	3450	3685	3875	-
	10	1525	1785	2045	2310	2570	2785	3045	3265	3570	3875	4135	4350	4725										
	340/85 R 46 (13.6 R 46)	150 A8/B	W 12	W 11	353	1746	826	5346	850	STD	km/h - bar	0.8	1.2	1.6	2.0	2.4	2.8	3.2	3.6	4.0				
50											1445	1880	2280	2480	2650	2915	3150	3350	-					
40											1445	1880	2280	2480	2650	2915	3150	3350	-					
30											1545	2010	2440	2655	2835	3120	3370	3585	-					
10	2065	2665	3220	3520	3770	4125	4475	4775	5025	-														

Technologies



Strong Casing

Performance



Durability



High Load Capacity



Self-Cleaning



Stability



Traction

Ø 48"	Tire size	LI/SS	RIM		S.W. (mm)	O.D. (mm)	SLR (mm)	RC (mm)	SRI (index)	Version	Load capacity (kg/tire)										
			Rec.	Alt.							km/h - bar	0.8	1.2	1.6	2.0	2.4	2.8	3.2	3.6	4.0	4.4
											50	40	30	10	65	50	40	30	10	65	50
230/95 R 48 (9.5 R 48)	136 A8/B	W 8	W 7	238	1656	792	5085	825	STD	50	875	1145	1390	1525	1615	1770	1930	2085	2240	-	
										40	875	1145	1390	1525	1615	1770	1930	2085	2240	-	
										30	940	1225	1490	1635	1730	1900	2065	2235	2400	-	
										10	1045	1315	1615	1920	2220	2285	2555	2825	3095	3360	
										km/h - bar	0.8	1.2	1.6	2.0	2.4	2.8	3.2	3.6	4.0	4.4	
230/95 R 48 (9.5 R 48)	136 D/ 139 A8	W 8	W 7	238	1656	792	5085	825	STD	50	785	920	1190	1435	1595	1680	1840	1995	2130	2240	
										40	825	970	1250	1510	1675	1770	1935	2100	2240	2355	
										30	855	1000	1290	1560	1730	1825	1995	2165	2310	2430	
										10	905	1060	1370	1655	1835	1935	2120	2300	2455	2580	
										10	1180	1380	1785	2155	2390	2520	2760	2995	3195	3360	
km/h - bar	0.8	1.2	1.6	2.0	2.4	2.8	3.2	3.6	4.0	4.4											
270/95 R 48 (11.2 R 48)	144 A8/B	W 9	W 8 ; W 10	275	1733	820	5351	850	STD	50	1095	1430	1740	1905	2020	2215	2410	2605	2800	-	
										40	1095	1430	1740	1905	2020	2215	2410	2605	2800	-	
										30	1170	1530	1860	2040	2160	2370	2580	2790	3000	-	
										10	1305	1640	2020	2395	2775	2860	3195	3530	3865	4200	
										km/h - bar	0.8	1.2	1.6	2.0	2.4	2.8	3.2	3.6	4.0	4.4	
340/85 R 48 (13.6 R 48)	151 D/ 154 A8	W 12	W 11	353	1797	855	5572	875	STD	65	1485	1660	1865	2040	2245	2385	2625	2830	3005	3175	3450
										50	1560	1740	1960	2140	2360	2505	2755	2975	3155	3335	3625
										40	1615	1800	2025	2215	2440	2590	2850	3075	3265	3450	370
										30	1710	1910	2145	2345	2585	2740	3020	3260	3455	3655	3970
										10	2230	2485	2975	3055	3365	3575	3935	4245	4505	4765	5175
km/h - bar	1.0	1.2	1.4	1.6	2.0	2.4	2.8	3.2	3.6	4.0	4.4										
340/85 R 48 (13.6 R 48)	152 A8/B	W 12	W 11	353	1797	855	5572	875	STD	50	1385	1815	2205	2415	2560	2805	3055	3305	3550	-	
										40	1385	1815	2205	2415	2560	2805	3055	3305	3550	-	
										30	1485	1940	2360	2585	2740	3005	3270	3535	3800	-	
										10	1655	2080	2560	3040	3515	3625	4050	4475	4900	5325	
										km/h - bar	0.8	1.2	1.6	2.0	2.4	2.8	3.2	3.6	4.0	4.4	
Ø 52"	300/95 R 52 (12.4 R 52)	151 A8/B	W 9	W 10 ; W 11 ; DW 10 ; DW 11	295	1891	889	5774	925	STD	50	1350	1760	2140	2350	2485	2730	2970	3210	3450	-
											40	1350	1760	2140	2350	2485	2730	2970	3210	3450	-
											30	1445	1885	2295	2515	2665	2920	3180	3440	3695	-
											10	1605	2020	2485	2950	3420	3520	3935	4350	4765	5175
											km/h - bar	0.8	1.2	1.6	2.0	2.4	2.8	3.2	3.6	4.0	4.4
Ø 54"	270/95 R 54 (11.2 R 54)	146 A8/B	W 9	W 8 ; W 10	275	1885	894	5815	925	STD	50	1170	1530	1860	2040	2160	2370	2580	2790	3000	-
											40	1170	1530	1860	2040	2160	2370	2580	2790	3000	-
											30	1255	1640	1995	2185	2315	2540	2765	2990	3210	-
											10	1395	1755	2160	2565	2970	3060	3420	3780	4140	4500
											km/h - bar	0.8	1.2	1.6	2.0	2.4	2.8	3.2	3.6	4.0	4.4

STD: Standard

Technologies



Strong Casing

Performance



Durability



High Load Capacity



Self-Cleaning



Stability



Traction



TRACTOR

Radial



AGRIMAX TURF RT 333

AGRIMAX TURF RT 333 (R-3+) is a radial tire designed for small tractors in gardening, vineyards and orchards applications. Its rounded shoulder design provides low soil compaction and makes it extremely delicate on the ground. Its unique extra-deep tread (R-3+) and the special design with directional blocks stand for excellent traction both in the field and on the road, and an extended tire life cycle. AGRIMAX TURF RT 333 (R-3+) ensures great self-cleaning properties and thanks to its low rolling resistance, allows for significant fuel saving.

AGRIMAX
RADIAL TRACTOR TIRES

Ø 12"	Tire size	LI/SS	RIM		S.W. (mm)	O.D. (mm)	SLR (mm)	RC (mm)	SRI (index)	Version	Load capacity (kg/tire)								
			Rec.	Alt.							km/h - bar	0.6	0.8	1.0	1.2	1.4	1.6	2.0	2.4
											50	40	30	10 LT	10 HT	50	40	30	10 LT
220/55 R 12	82 A8/B	W 7	-	221	550	249	1645	260	STD	50	225	265	300	335	370	395	445	475	
										40	225	265	300	335	370	395	445	475	
										30	240	285	325	360	395	425	475	510	
										10 LT	305	355	405	450	495	535	600	640	
										10 HT	240	285	325	360	395	425	475	510	
240/60 R 12	89 A8/B	W 7	-	242	592	269	1777	-	STD	50	270	310	355	395	445	485	540	580	
										40	270	310	355	395	445	485	540	580	
										30	290	335	385	425	475	520	585	625	
										10 LT	360	415	480	535	595	650	730	780	
										10 HT	290	335	385	425	475	520	585	625	
Ø 16"	200/65 R 16	94 A8/B	W 6	-	202	666	309	2000	320	STD	50	315	370	425	470	520	560	625	670
											40	315	370	425	470	520	560	625	670
											30	340	400	455	505	555	600	670	720
											10 LT	425	495	570	630	695	750	840	900
											10 HT	340	400	455	505	555	600	670	720
200/70 R 16	94 A8/B	W 6	-	200	686	317	2054	330	STD	50	315	365	420	470	525	580	625	670	
										40	315	365	420	470	525	580	625	670	
										30	340	390	450	505	565	620	670	720	
										10 LT	425	490	560	630	705	775	840	900	
										10 HT	340	390	450	505	565	620	670	720	
240/70 R 16	104 A8/B	W 8	W 8 L ; W 9	244	742	340	2213	350	STD	50	425	490	560	630	705	775	850	900	
										40	425	490	560	630	705	775	850	900	
										30	455	525	600	680	755	830	910	965	
										10 LT	570	655	755	850	945	1045	1140	1210	
										10 HT	455	525	600	680	755	830	910	965	
260/70 R 16	109 A8/ 109 B	W 8	W 8 L ; W 9	258	770	348	2287	370	STD	50	485	560	640	725	805	890	970	1030	
										40	485	560	640	725	805	890	970	1030	
										30	520	600	690	775	865	955	1040	1105	
										10 LT	655	750	860	970	1085	1195	1305	1385	
										10 HT	520	600	690	775	865	955	1040	1105	
280/70 R 16	112 A8/ 112 B	W 9	W 8 ; W 10	289	800	359	2371	390	STD	50	530	605	695	785	875	965	1055	1120	
										40	530	605	695	785	875	965	1055	1120	
										30	565	650	745	840	940	1035	1130	1200	
										10 LT	710	815	935	1055	1175	1295	1415	1505	
										10 HT	565	650	745	840	940	1035	1130	1200	
Ø 18"	280/70 R 18	114 A8/ 114 B	W 9	W 8 ; W 10	289	840	390	2550	410	STD	50	555	640	735	830	925	1015	1110	1180
											40	555	640	735	830	925	1015	1110	1180
											30	595	685	785	890	990	1090	1190	1265
											10 LT	745	860	985	1110	1240	1365	1490	1585
											10 HT	595	695	785	890	990	1090	1190	1265

Technologies



Extra Deep Tread

Performance



Durability



Low Rolling Resistance



Reduced Soil Compaction



Self-Cleaning



Traction

STD: Standard



AGRIMAX TURF RT 333

Ø 18"	Tire size	LI/SS	RIM		S.W. (mm)	O.D. (mm)	SLR (mm)	RC (mm)	SRI (index)	Version	Load capacity (kg/tire)						
			Rec.	Alt.							km/h - bar	0.6	0.8	1.0	1.2	1.4	1.6
Ø 18"	320/65 R 18	109 A8/ 109 B	W10	W9 ; W11	319	873	394	2591	425	STD	50	570	660	755	845	940	1030
											40	570	660	755	845	940	1030
											30	610	710	810	910	1010	1105
											10 LT	765	890	1015	1140	1265	1385
											10 HT	610	710	810	910	1010	1105
											km/h - bar	0.6	0.8	1.0	1.2	1.4	1.6
Ø 20"	300/70 R 20	110 A8/ 110 B	W9	W10	295	952	431	2826	450	STD	50	585	680	775	870	965	1060
											40	585	680	775	870	965	1060
											30	625	730	830	935	1035	1135
											10 LT	785	915	1045	1170	1300	1425
											10 HT	625	730	830	935	1035	1135
											km/h - bar	0.6	0.8	1.0	1.2	1.4	1.6
	320/70 R 20	113 A8/ 113 B	W10	W9 ; W11	319	982	441	2916	475	STD	50	635	740	840	945	1050	1150
											40	635	740	840	945	1050	1150
											30	680	795	905	1015	1125	1235
											10 LT	850	990	1130	1270	1410	1545
											10 HT	680	795	905	1015	1125	1235
											km/h - bar	0.6	0.8	1.0	1.2	1.4	1.6
	380/70 R 20	122 A8/ 122 B	W 12	W 11 ; W 13	380	1082	486	3213	525	STD	50	825	960	1095	1230	1365	1500
											40	825	960	1095	1230	1365	1500
											30	885	1030	1175	1320	1465	1605
											10 LT	1110	1290	1470	1650	1830	2010
											10 HT	885	1030	1175	1320	1465	1605
											km/h - bar	0.6	0.8	1.0	1.2	1.4	1.6
Ø 24"	360/70 R 24	122 A8/ 122 B	W 11	W 10 ; W 12	357	1152	518	3409	550	STD	50	825	960	1095	1230	1365	1500
											40	825	960	1095	1230	1365	1500
											30	885	1030	1175	1320	1465	1605
											10 LT	1110	1290	1470	1650	1830	2010
											10 HT	885	1030	1175	1320	1465	1605
											km/h - bar	0.6	0.8	1.0	1.2	1.4	1.6
	380/70 R 24	125 A8/ 125 B	W 12	W 11 ; W 13	380	1190	534	3538	575	STD	50	910	1060	1205	1355	1505	1650
											40	910	1060	1205	1355	1505	1650
											30	975	1135	1295	1455	1615	1770
											10 LT	1220	1420	1620	1820	2020	2215
											10 HT	975	1135	1295	1455	1615	1770
											km/h - bar	0.6	0.8	1.0	1.2	1.4	1.6
	420/70 R 24	130 A8/ 130 B	W 13	W 12 ; W 14 L	418	1248	557	3728	600	STD	50	1045	1220	1390	1560	1730	1900
											40	1045	1220	1390	1560	1730	1900
											30	1120	1305	1490	1670	1855	2035
											10 LT	1405	1635	1865	2095	2325	2550
											10 HT	1120	1305	1490	1670	1855	2035
											km/h - bar	0.6	0.8	1.0	1.2	1.4	1.6

STD: Standard

Technologies

- Extra Deep Tread
- Performance
- Durability
- Low Rolling Resistance
- Reduced Soil Compaction
- Self-Cleaning
- Traction



TRACTOR

AGRIMAX TURF RT 333

Ø 28"	Tire size	LI/SS	RIM		S.W. (mm)	O.D. (mm)	SLR (mm)	RC (mm)	SRI (index)	Version	Load capacity (kg/tire)								
			Rec.	Alt.							km/h - bar	0.6	0.8	1.0	1.2	1.4	1.6		
480/70 R 28	140 A8 / 140 B	W 15 L	W 14 L ; W 16 L	479	1421	631	4228	675	STD	50	1375	1600	1825	2050	2275	2500			
										40	1375	1600	1825	2050	2275	2500			
										30	1475	1715	1955	2195	2435	2675			
										10 LT	1845	2145	2450	2750	3050	3350			
										10 HT	1475	1715	1955	2195	2435	2675			
Ø 30"	480/70 R 30	141 A8 / 141 B	W 15 L	W 14 L ; W 16 L	479	1478	660	4396	700	STD	50	1420	1650	1880	2115	2345	2575		
											40	1420	1650	1880	2115	2345	2575		
											30	1520	1770	2015	2265	2515	2760		
											10 LT	1905	2215	2525	2835	3145	3455		
											10 HT	1520	1770	2015	2265	2515	2760		
Ø 34"	480/70 R 34	149 A8 / 149 B	W 15 L	W 14 L ; W 16 L	479	1580	723	4785	750	STD	50	1530	1755	2015	2275	2535	2795	3055	3250
											40	1530	1755	2015	2275	2535	2795	3055	3250
											30	1640	1880	2160	2440	2715	2995	3275	3480
											10 LT	2050	2355	2705	3050	3400	3750	4095	4355
											10 HT	1640	1880	2160	2440	2715	2995	3275	3480

STD: Standard

Technologies



Extra Deep Tread

Performance



Durability



Low Rolling Resistance



Reduced Soil Compaction



Self-Cleaning



Traction



RT 851 (R-1)

RT 851 is a R-1 tire specially engineered for tractors in grassland applications. The special rounded lug design has been developed to reduce any damage to grassland and emerging crops as well as soil compaction. The strong nylon casing with rugged polyester belts provides extraordinary traction as well as increased load capacity.

Ø 20"	Tire size	LI/SS	RIM		S.W. (mm)	O.D. (mm)	SLR (mm)	RC (mm)	SRI (index)	Version	Load capacity (kg/tire)						
			Rec.	Alt.							km/h - bar	0.6	0.8	1.0	1.2	1.4	1.6
375/75 R 20 (14.9L R 20)	119 A8/B	W 13	W 11 ; W 12 ; W 14	378	1100	498	3286	525	STD	50	750	875	995	1120	1240	1360	
										40	750	875	995	1120	1240	1360	
										30	805	935	1070	1200	1330	1460	
										10 LT	1005	1170	1335	1500	1665	1825	
										10 HT	805	935	1070	1200	1330	1460	

STD: Standard

Performance



RT 853 (R-1)

RT 853 is a R-1 tire for tractors and vineyard harvesters in soil tillage and vineyard harvesting applications. It features great traction, load capacity and self-cleaning properties

Ø 38"	Tire size	LI/SS	RIM		S.W. (mm)	O.D. (mm)	SLR (mm)	RC (mm)	SRI (index)	Version	Load capacity (kg/tire)						
			Rec.	Alt.							km/h - bar	0.6	0.8	1.0	1.2	1.4	1.6
480/80 R 38 (18.4 R 38)	149 A8/B	W 16 L	W 15 L ; W 14 L	475	1747	793	5300	825	STD	50	1790	2080	2375	2665	2960	3250	
										40	1790	2080	2375	2665	2960	3250	
										30	1915	2230	2545	2855	3170	3480	
										10 LT	2400	2790	3180	3575	3965	4355	
										10 HT	1915	2230	2545	2855	3170	3480	
520/85 R 38 (20.8 R 38)	155 A8/B	DW 16 L	DW 18 L ; DD 16 L	516	1849	830	5592	875	STD	50	2135	2480	2830	3180	3530	3875	
										40	2135	2480	2830	3180	3530	3875	
										30	2285	2660	3030	3405	3780	4150	
										10 LT	2860	3325	3795	4260	4730	5195	
										10 HT	2285	2660	3030	3405	3780	4150	

STD: Standard

Performance





TRACTOR

Radial



RT 857 (R-1)

RT 857 is a tire designed for soil tillage applications. Its strong casing offers excellent durability and traction. The stubble-resistant tread compound features high cut-and-chip resistance.

Ø 24"	Tire size	LI/SS	RIM		S.W. (mm)	O.D. (mm)	SLR (mm)	RC (mm)	SRI (index)	Version	Load capacity (kg/tire)						
			Rec.	Alt.							km/h - bar	0.6	0.8	1.0	1.2	1.4	1.6
											50	40	30	10 LT	10 HT	50	40
320/85 R 24 (12.4 R 24)	122 A8/B	W 11	W 10 ; W 9	329	1154	528	3449	550	STD	50	825	960	1095	1230	1365	1500	
										40	825	960	1095	1230	1365	1500	
										30	885	1030	1175	1320	1465	1605	
										10 LT	1110	1290	1470	1650	1830	2010	
										10 HT	885	1030	1175	1320	1465	1605	
380/85 R 24 (14.9 R 24)	131 A8/B	W 12	W 13 ; W 11	380	1256	566	3783	600	STD	50	1075	1250	1425	1600	1775	1950	
										40	1075	1250	1425	1600	1775	1950	
										30	1150	1340	1530	1715	1905	2090	
										10 LT	1440	1675	1910	2145	2380	2615	
										10 HT	1150	1340	1530	1715	1905	2090	
Ø 26"	420/85 R 26 (16.9 R 26)	138 A8/B	DW 15 L	W 14 L ; W 15 L ; W 16 L ; DW 16 L	438	1374	616	4115	650	STD	50	1300	1515	1725	1940	2150	2360
											40	1300	1515	1725	1940	2150	2360
											30	1395	1620	1850	2075	2305	2530
											10 LT	1745	2030	2315	2600	2885	3165
											10 HT	1395	1620	1850	2075	2305	2530
460/85 R 26 (18.4 R 26)	143 A8/B	DW 15 L	W 15 L ; W 16 L ; DW 16 L	465	1442	642	4297	675	STD	50	1500	1745	1990	2235	2480	2725	
										40	1500	1745	1990	2235	2480	2725	
										30	1610	1870	2135	2395	2660	2920	
										10 LT	2015	2340	2670	3000	3330	3655	
										10 HT	1610	1870	2135	2395	2660	2920	
Ø 28"	320/85 R 28 (12.4 R 28)	124 A8/B	W 11	W 9 ; W 10	329	1255	577	3779	600	STD	50	880	1025	1170	1315	1460	1600
											40	880	1025	1170	1315	1460	1600
											30	945	1100	1255	1410	1565	1715
											10 LT	1180	1375	1570	1760	1955	2145
											10 HT	945	1100	1255	1410	1565	1715
340/85 R 28 (13.6 R 28)	127 A8/B	W 12	W 11	353	1289	599	3908	625	STD	50	965	1120	1280	1435	1595	1750	
										40	965	1120	1280	1435	1595	1750	
										30	1035	1200	1370	1540	1710	1875	
										10 LT	1290	1505	1715	1925	2135	2345	
										10 HT	1035	1200	1370	1540	1710	1875	
380/85 R 28 (14.9 R 28)	133 A8/B	W 12	W 11 ; W 13	390	1357	617	4127	650	STD	50	1135	1320	1505	1690	1875	2060	
										40	1135	1320	1505	1690	1875	2060	
										30	1215	1415	1610	1810	2010	2205	
										10 LT	1525	1770	2020	2270	2520	2765	
										10 HT	1215	1415	1610	1810	2010	2205	

Technologies



Performance



STD: Standard



TRACTOR

RT 857 (R-1)

Ø 28"	Tire size	LI/SS	RIM		S.W. (mm)	O.D. (mm)	SLR (mm)	RC (mm)	SRI (index)	Version	Load capacity (kg/tire)						
			Rec.	Alt.							km/h - bar	0.6	0.8	1.0	1.2	1.4	1.6
420/85 R 28 (16.9 R 28)	139 A8/B	W 15 L	W 14 L; W 13	450	1425	640	4276	675	STD	50	1340	1560	1775	1995	2215	2430	
										40	1340	1560	1775	1995	2215	2430	
										30	1435	1670	1905	2140	2375	2605	
										10 LT	1795	2090	2380	2675	2970	3260	
										10 HT	1435	1670	1905	2140	2375	2605	
Ø 30"	420/85 R 30 (16.9 R 30)	140 A8/B	W 15 L	W 14 L; W 13	438	1476	656	4398	700	STD	50	1375	1600	1825	2050	2275	2500
											40	1375	1600	1825	2050	2275	2500
											30	1475	1715	1955	2195	2435	2675
											10 LT	1845	2145	2450	2750	3050	3350
											10 HT	1475	1715	1955	2195	2435	2675
460/85 R 30 (18.4 R 30)	145 A8/B	W 16 L	W 15 L; W 14 L	475	1544	697	4648	725	STD	50	1595	1860	2120	2380	2640	2900	
										40	1595	1860	2120	2380	2640	2900	
										30	1710	1990	2270	2550	2830	3105	
										10 LT	2140	2490	2840	3190	3540	3890	
										10 HT	1710	1990	2270	2550	2830	3105	

STD: Standard

Technologies



Special Compound



Strong Casing

Performance



Cut and Chip Resistance



Durability



High Load Capacity



Traction





TRACTOR

Radial



RIDEMAX IT 696

RIDEMAX IT 696 has a unique tread design and a wide footprint that provides excellent grip for road applications, even in winter conditions. The tire is best suitable for transport and municipality/maintenance applications thanks to its high-speed feature and strong casing. The tread design has been specifically developed for heavy-duty services and ensures a low rolling resistance that provides fuel economy plus great stability.

RIDEMAX
RADIAL TRANSPORT TIRES

Ø 16"	Tire size	LI/SS	RIM		S.W. (mm)	O.D. (mm)	SLR (mm)	RC (mm)	SRI (index)	Version	Load capacity (kg/tire)								
			Rec.	Alt.							km/h - bar	1.2	1.6	2.0	2.4	2.8			
Ø 16"	240/70 R 16 IND	107 A8/ 107 B	W8	W9	244	742	343	2226	350	STD	km/h - bar	1.2	1.6	2.0	2.4	2.8			
											50	545	675	730	860	975			
											40	545	675	730	860	975			
											30	585	725	785	985	1045			
											20	675	835	900	1135	1200			
Ø 18"	340/80 R 18 IND	143 A8/ 138 D	11 ; 11 SDC ; W 11	W 10 ; 12 ; 12 SDC	343	1001	458	2980	475	STD	km/h - bar	1.2	1.6	2.0	2.4	2.8	3.2	3.5	4.0
											65	920	1135	1345	1535	1745	1960	2100	2360
											50	995	1225	1455	1660	1885	2115	2270	2550
											40	1065	1310	1555	1770	2015	2260	2425	2725
											30	1275	1570	1865	2125	2420	2715	2910	3270
Ø 20"	360/80 R 20 IND	143D/ 147A8	11	W 10 ; W 11 ; 12 ; W 12	357	1084	488	3235	525	STD	km/h - bar	1.2	1.6	2.0	2.4	2.8	3.2	3.6	4.0
											65	1310	1585	1885	2100	2180	2265	2480	2725
											50	1415	1710	2035	2270	2360	2445	2680	2945
											40	1480	1785	2125	2370	2460	2555	2800	3075
											30	1570	1900	2260	2520	2620	2715	2980	3270
Ø 24"	300/80 R 24 IND (11.2 R 24)	133 A8/ 128 D	DW 10	-	295	1090	501	3296	525	STD	km/h - bar	1.2	1.6	2.0	2.4	2.8	3.2		
											65	845	1045	1225	1420	1600	1800		
											50	910	1125	1320	1535	1725	1940		
											40	970	1195	1400	1625	1835	2060		
											30	1010	1245	1460	1700	1915	2150		
Ø 24"	340/80 R 24 IND (12.4 R 24)	140 A8/ 135 D	DW 11	W 10 ; W 12 ; DW 10	343	1154	521	3444	550	STD	km/h - bar	1.2	1.6	2.0	2.4	2.8	3.2		
											65	1025	1265	1480	1720	1940	2180		
											50	1105	1365	1600	1855	2090	2350		
											40	1175	1450	1700	1975	2225	2500		
											30	1220	1510	1770	2055	2315	2600		
Ø 24"	360/80 R 24 IND (13.6 R 24)	143 A8/ 138 D	DW 11	W 12 ; W 10	343	1186	537	3556	575	STD	km/h - bar	1.2	1.6	2.0	2.4	2.8	3.2		
											65	1110	1370	1605	1865	2100	2360		
											50	1200	1480	1735	2015	2270	2550		
											40	1280	1580	1855	2155	2425	2725		
											30	1535	1895	2225	2585	2910	3270		
Ø 24"	400/80 R 24 IND (14.9 R 24)	149 A8/ 144 D	DW 13	W 12 ; W 14 L	404	1250	558	3760	600	STD	km/h - bar	1.2	1.6	2.0	2.4	2.8	3.2		
											65	1315	1625	1905	2210	2490	2800		
											50	1440	1775	2080	2415	2725	3060		
											40	1530	1885	2210	2570	2895	3250		
											30	1590	1960	2300	2670	3010	3380		
Ø 24"	420/65 R 24 IND	146 D/ 151 A8	DW 13 L ; W13	DW 15 L ; DW 14 L	418	1158	530	3483	550	STD	km/h - bar	1.2	1.6	2.0	2.4	2.8	3.2	3.6	4.0
											65	1200	1470	1650	1950	2220	2490	2730	3000
											50	1295	1590	1780	2105	2400	2690	2950	3240
											40	1380	1690	1900	2245	2555	2865	3140	3450
											30	1440	1765	1980	2340	2665	2990	3275	3600
Ø 24"	440/80 R 24 IND (16.9 R 24)	154 A8/ 149 D	DW 14 L	DW 15 L ; DW 13	441	1314	590	3939	625	STD	km/h - bar	1.2	1.6	2.0	2.4	2.8	3.2	3.6	4.0
											65	1530	1885	2210	2570	2895	3250		
											50	1650	2035	2385	2775	3125	3510		
											40	1765	2175	2550	2965	3340	3750		
											30	2115	2610	3060	3555	4005	4500		
Ø 24"	460/65 R 24 IND	151 D/ 156 A8	DW 14 L	DW 15 L ; DW 13	455	1214	549	3644	600	STD	km/h - bar	1.2	1.6	2.0	2.4	2.8	3.2	3.6	4.0
											65	1380	1690	1900	2245	2555	2865	3140	3450
											50	1490	1830	2050	2425	2760	3095	3395	3730
											40	1600	1960	2200	2600	2960	3320	3640	4000
											30	1655	2030	2275	2790	3065	3435	3765	4140

STD: Standard

Technologies



Block Pattern



High Speed



Larger Footprint



Strong Casing

Performance



Durability



Fuel Economy



Heavy Duty



Road Oriented



Stability





RIDEMAX IT 696

Ø 24"	Tire size	LI/SS	RIM		S.W. (mm)	O.D. (mm)	SLR (mm)	RC (mm)	SRI (index)	Version	Load capacity (kg/tire)							
			Rec.	Alt.							km/h - bar	1.2	1.6	2.0	2.4	2.8	3.2	
500/70 R 24 IND	157 A8/152 D	DW 16 L	DW 15 L ; DW 18 L	503	1310	602	3954	625	STD	km/h - bar	1.2	1.6	2.0	2.4	2.8	3.2		
										65	1775	2170	2380	2805	3160	3550		
										50	1920	2340	2570	3030	3415	3835		
										40	2065	2520	2765	3260	3675	4125		
500/70 R 24 IND	164 A8/159 D	DW 16 L	DW 15 L ; DW 18 L	503	1310	602	3954	625	STD	km/h - bar	1.2	1.6	2.0	2.4	2.8	3.2	3.6	4.0
										65	1750	2145	2410	2845	3240	3635	3985	4375
										50	1890	2320	2600	3075	3500	3925	4300	4725
										40	2000	2450	2750	3250	3700	4150	4550	5000
400/80 R 28 IND (14.9 R 28)	151 A8/146 D	W 13	W 12 ; W 14 L	404	1352	615	4048	650	STD	km/h - bar	1.2	1.6	2.0	2.4	2.8	3.2		
										65	1410	1740	2040	2370	2670	3000		
										50	1530	1890	2215	2575	2900	3260		
										40	1620	2000	2345	2725	3070	3450		
440/80 R 28 IND (16.9 R 28)	156 A8/151 D	W 14 L	W 15 L	441	1415	634	4288	675	STD	km/h - bar	1.2	1.6	2.0	2.4	2.8	3.2		
										65	1620	2000	2345	2725	3070	3450		
										50	1765	2180	2555	2970	3345	3760		
										40	1880	2320	2720	3160	3560	4000		
440/80 R 30 IND (16.9 R 30)	157 A8/153 D	W 14 L	W 15 L	441	1466	668	4456	700	STD	km/h - bar	1.2	1.6	2.0	2.4	2.8	3.2		
										65	1715	2115	2480	2885	3250	3650		
										50	1825	2250	2640	3065	3455	3880		
										40	1940	2395	2805	3260	3670	4125		
480/80 R 30 IND (18.4 R 30)	162 A8/157 D	W 15 L	W 16 L	479	1530	673	4558	725	STD	km/h - bar	1.2	1.6	2.0	2.4	2.8	3.2		
										65	1940	2395	2805	3260	3670	4125		
										50	2105	2600	3045	3540	3985	4480		
										40	2235	2755	3230	3755	4230	4750		
440/80 R 34 IND (16.9 R 34)	159 A8/155 D	DW 14 L	DW 15 L ; DW 16 L	441	1567	704	4775	750	STD	km/h - bar	1.2	1.6	2.0	2.4	2.8	3.2		
										65	1820	2250	2635	3060	3450	3875		
										50	1935	2390	2800	3255	3665	4120		
										40	2055	2540	2975	3455	3895	4375		
480/80 R 34 IND (18.4 R 34)	164 A8/159 D	W 15 L	W 16 L	479	1632	728	4894	775	STD	km/h - bar	1.2	1.6	2.0	2.4	2.8	3.2		
										65	2055	2540	2975	3455	3895	4375		
										50	2210	2725	3195	3715	4185	4700		
										40	2350	2900	3400	3950	4450	5000		
480/80 R 34 IND (18.4 R 34)	164 A8/159 D	W 15 L	W 16 L	479	1632	728	4894	775	STD	km/h - bar	1.2	1.6	2.0	2.4	2.8	3.2		
										65	2445	3015	3535	4110	4630	5200		

STD: Standard

Technologies



Block Pattern



High Speed



Larger Footprint



Strong Casing

Performance



Durability



Fuel Economy



Heavy Duty



Road Oriented



Stability





TRACTOR

RIDEMAX IT 696

Ø 38"	480/80 R 38 IND (18.4 R 38)	166 A8/ 161 D	W 15 L	W 16 L	479	1733	780	5213	825	STD		km/h - bar	1.2	1.6	2.0	2.4	2.8	3.2
												65	2175	2685	3145	3655	4115	4625
50	2350	2900	3400	3950	4450	5000												
40	2490	3075	3605	4185	4715	5300												
30	2595	3200	3755	4360	4915	5520												
Ø 38"	540/80 R 38 IND	172 A8/ 167 D	W 18 L	W 16 L	550	1829	833	5537	875	STD		km/h - bar	1.2	1.6	2.0	2.4	2.8	3.2
												65	2560	3160	3705	4305	4850	5450
50	2770	3415	4005	4655	5240	5890												
40	2960	3655	4285	4975	5605	6300												
30	3555	4385	5140	5970	6730	7560												
Ø 42"	540/80 R 42	168 D/ 173 A8	W 18 L	W 16 L	560	1931	879	5875	925	STD		km/h - bar	1.2	1.6	2.0	2.4	2.8	3.2
												65	2630	3250	3810	4425	4985	5600
50	2845	3510	4115	4780	5385	6050												
40	3055	3770	4420	5135	5785	6500												
30	3665	4525	5305	6160	6940	7800												

STD: Standard

Technologies



Block Pattern



High Speed



Larger Footprint



Strong Casing

Performance



Durability



Fuel Economy



Heavy Duty



Road Oriented



Stability



TRACTOR

Radial



RIDEMAX IT 697 (M+S)

RIDEMAX IT 697 M+S represents the best response to the needs of modern farming contractors during winter operations. It is perfect for haulage and municipality applications. This winter tire for tractors ensures extraordinary grip for all operations on icy and snowy roads without the need of snow chains being mounted. Thanks to the tread grooves and the strong casing, a tractor can be driven in full stability, also at high speed levels. The tread design has been specially developed for heavy-duty services and ensures a low rolling resistance that provides fuel economy plus great stability.

RIDEMAX
RADIAL TRANSPORT TIRES

Ø 24"	Tire size	LI/SS	RIM		S.W. (mm)	O.D. (mm)	SLR (mm)	RC (mm)	SRI (index)	Version	Load capacity (kg/tire)									
			Rec.	Alt.							km/h - bar									
											1.2	1.6	2.0	2.4	2.8	3.2				
460/70 R 24 IND	157 A8/152 D	DW 15 L	DW14 L ; DW 16L	465	1254	571	3772	600	STD	65	1775	2170	2380	2805	3160	3550				
										50	1920	2340	2570	3030	3415	3835				
										40	2065	2520	2765	3260	3675	4125				
										30	2130	2600	2855	3370	3795	4260				
540/70 R 24 IND	170D/175A8	DW 16 L	DW18 L	535	1370	625	4181	650	STD	65	2040	2520	2760	3240	3660	4080	4500	4920	5460	6000
										50	2205	2725	2985	3500	3955	4410	4860	5315	5900	6480
										40	2350	2900	3175	3730	4210	4695	5175	5660	6280	6900
										30	2450	3025	3315	3890	4395	4900	5400	5905	6555	7200
Ø 28"	480/65 R 28 IND	149 D/154 A8	DW 15 L	-	480	1335	615	4088	650	STD	65	1530	1885	2210	2570	2895	3250			
											50	1650	2035	2385	2775	3125	3510			
											40	1765	2175	2550	2965	3340	3750			
											30	1835	2260	2650	3080	3470	3900			
540/65 R 28 IND	155 D/160 A8	W 16 L	W 18	530	1413	642	4276	675	STD	65	1820	2250	2635	3060	3450	3875				
										50	1965	2425	2845	3305	3725	4185				
										40	2115	2610	3060	3555	4005	4500				
										30	2185	2695	3160	3675	4140	4650				
600/65 R 28 IND	165 A8/160 D	W 18 L	DW 20 B	591	1491	684	4509	700	STD	65	2205	2700	2970	3555	4005	4500				
										50	2385	2920	3210	3840	4330	4860				
										40	2525	3090	3400	4070	4585	5150				
										30	2650	3240	3565	4270	4810	5400				
Ø 30"	540/65 R 30 IND	156 D/161 A8	W 16 L	W 18	530	1464	672	4445	700	STD	65	1880	2320	2720	3160	3560	4000			
											50	2030	2505	2940	3415	3845	4320			
											40	2175	2685	3145	3655	4115	4625			
											30	2255	2785	3265	3790	4270	4800			
600/70 R 30 IND	166 D/171 A8	DW 18 L	DW 20 B	600	1600	688	4820	750	STD	65	2490	3075	3605	4185	4715	5300				
										50	2690	3320	3895	4525	5095	5725				
										40	2890	3565	4180	4860	5475	6150				
										30	2990	3690	4325	5025	5660	6360				
Ø 38"	600/65 R 38 IND	166 D/170 A8	DW 18 B	-	590	1745	795	5315	825	STD	65	2490	3075	3605	4185	4715	5300			
											50	2690	3320	3895	4525	5095	5725			
											40	2820	3480	4080	4740	5340	6000			
											30	2990	3690	4325	5025	5660	6360			

STD: Standard

Technologies



Performance



Ø 38"	Tire size	LI/SS	RIM		S.W. (mm)	O.D. (mm)	SLR (mm)	RC (mm)	SRI (index)	Version	Load capacity (kg/tire)						
			Rec.	Alt.							km/h - bar	1.2	1.6	2.0	2.4	2.8	3.2
650/65 R 38 IND	170 D/175 A8	DW 20 B	DW 18 L	645	1811	823	5514	875	STD	65	2820	3480	4080	4740	5340	6000	
										50	3045	3760	4405	5120	5765	6480	
										40	3245	4000	4690	5450	6140	6900	
										30	3385	4175	4895	5690	6410	7200	
650/85 R 38 IND	178 D/183 A8	DW 23 B	DW 20 B ; DW 21 B	709	2071	974	6280	975	STD	65	3525	4350	5100	5925	6675	7500	
										50	3805	4700	5510	6400	7210	8100	
										40	4115	5075	5950	6915	7790	8750	
										30	4230	5220	6120	7110	8010	9000	
710/70 R 38 IND	177 D/182 A8	DW 23 B	DW 25 B	716	1959	900	5950	925	STD	65	3650	4455	4895	5770	6500	7300	
										50	3945	4810	5285	6230	7020	7885	
										40	4250	5185	5695	6715	7565	8500	
										30	4115	5345	5870	6925	7800	8760	
Ø 42"	650/65 R 42 IND	171 D/176 A8	DW 20 B	DW 18 L	645	1920	880	5869	925	STD	65	2890	3565	4180	4860	5475	6150
											50	3125	3855	4520	5250	5915	6645
											40	3335	4120	4830	5610	6320	7100
											30	3470	4280	5020	5830	6570	7380
710/70 R 42 IND	180 D/185 A8	DW23 B	-	716	2068	926	6264	975	STD	65	3760	4640	5440	6320	7120	8000	
										50	4060	5010	5875	6825	7690	8640	
										40	4350	5365	6290	7310	8235	9250	
										30	4510	5570	6530	7585	8545	9600	

STD: Standard

Technologies



High Speed



Block Pattern



Larger Footprint



Strong Casing

Performance



Durability



Fuel Economy



Heavy Duty



Ice and Snow



Road Oriented



Stability





TRACTOR

Radial



TRAC SUPER

TR 126 is designed to fit small tractors in soil tillage operations. The deep lugs and the tread pattern provide excellent traction and outstanding load capacity features providing best tire performance in all operating conditions.

Ø 15"	Tire size	LI/SS	RIM		S.W. (mm)	O.D. (mm)	SLR (mm)	RC (mm)	SRI (index)	Version	Load capacity (kg/tire)			
			Rec.	Alt.							km/h - bar	0.8	1.2	1.6
400/50 R 15	118A8/B	13.00	-	380	775	329	2269	370	STD	50	845	1085	1320	
										40	845	1085	1320	
										30	950	1215	1480	
										20	1070	1370	1665	
										10	1185	1520	1850	

Ø 17"	Tire size	LI/SS	Rec.	Alt.	S.W. (mm)	O.D. (mm)	SLR (mm)	RC (mm)	SRI (index)	Version	Load capacity (kg/tire)									
											km/h - bar	0.8	1.0	1.2	1.6	2.0	2.4	2.8	3.2	3.6
440/50 R 17	135 D	14.00	13.00	441	872	395	2674	410	STD	65	955	960	1070	1265	1440	1635	1855	1985	2180	
										40	1300	1305	1455	1720	1960	2225	2525	2700	2965	
										30	1440	1450	1615	1915	2175	2475	2805	3000	3295	
										10	1720	1730	1925	2280	2595	2945	3340	3575	3925	
500/50 R 17	147 D	16.00	-	490	940	-	-	450	STD	65	1200	1450	1665	1940	2185	2400	2645	2895	3075	
										50	1635	1970	2260	2640	2975	3265	3600	3935	4185	
										40	1815	2185	2510	2930	3300	3625	3995	4370	4645	
										30	2160	2605	2990	3490	3930	4320	4765	5205	5535	

STD: Standard

Technologies



Steel Belted

Performance



Stability



Traction



TRACTOR

Radial



RT 747 AGRO INDUSTRIAL (R-4)

RT 747 AGRO INDUSTRIAL is a radial agro-industrial tire suitable for compact loaders and telehandlers. Its extra wide lugs provide excellent traction and great stability in lifting operations. It has been designed with a special cut-and-chip resistance compound that enables the tire to carry heavy loads. RT 747 AGRO INDUSTRIAL is the right answer to all general farming operations that need outstanding versatility.

Ø 16"	Tire size	LI/SS	RIM		S.W. (mm)	O.D. (mm)	SLR (mm)	RC (mm)	SRI (index)	Version	Load capacity (kg/tire)								
			Rec.	Alt.							km/h - bar	1.2	1.6	2.0	2.2	2.4	2.6		
Ø 16"	11L R 16	122 A8/B	W 8	W 10 L	290	850	-	-	-	STD	10	1265	1530	1790	1920	2055	2200		
											30	940	1165	1385	1500	1610	-		
											40	880	1085	1295	1395	1500	-		
Ø 24"	460/70 R 24 (17.5L R 24)	152 A8/B	DW 15 L	DW 14 L ; DW 16 L	465	1254	556	3840	575	STD	50	1670	2060	2415	2805	3160	3550		
											40	1670	2060	2415	2805	3160	3550		
											30	1785	2205	2585	3000	3380	3800		
											25	1850	2285	2680	3115	3505	3940		
											10 Cyc	2505	3090	3620	4205	4740	5325		
											Static	3505	4325	5070	5890	6635	7455		
	460/70 R 24 (17.5L R 24)	159 A8/ 156 B	DW 15 L	DW 14 L ; DW 16 L	465	1254	556	3840	575	STD	50	1535	1890	2245	2560	2915	3265	3505	4000
											40	1705	2100	2495	2845	3240	3630	3895	4375
											30	1775	2185	2595	2960	3370	3775	4050	4550
											25	1805	2225	2645	3015	3435	3850	4130	4640
											10 Cyc	2560	3150	3745	4270	4860	5445	5845	6565
											Static	3920	4830	5740	6545	7450	8350	8960	10065
	500/70 R 24 (19.5L R 24)	157 A8/ 154 B	DW 16 L	DW 15 L ; DW 18 L	485	1320	585	3949	625	STD	50	1765	2175	2550	2965	3340	3750		
											40	1940	2395	2805	3260	3670	4125		
											30	2075	2560	3000	3490	3930	4415		
25											2155	2655	3115	3620	4075	4580			
10 Cyc											2910	3590	4210	4890	5510	6190			
Static											4075	5025	5890	6845	7710	8665			

STD: Standard

Technologies



Special Compound



More Lugs

Performance



Cut and Chip Resistance



High Load Capacity



Stability



Traction





TRACTOR

Bias



TR 126 (R-1)

TR 126 is designed to fit small tractors in soil tillage operations. The deep lugs and the tread pattern provide excellent traction and outstanding load capacity features providing best tire performance in all operating conditions.

Ø 14"	Tire size	RIM		S.W. (mm)	O.D. (mm)	SLR (mm)	RC (mm)	Version	PR	Type	LI/SS	Load capacity (kg/tire)		
		Rec.	Alt.									km/h - bar		
6 - 14	5 JA ; 5 KB	-		157	655	305	1978	STD	4	TL	66 A6	30	1.90	300
6 - 14	5 JA ; 5 KB	-		157	655	305	1978	STD	4	TT	66 A6	30	1.90	300
6 - 14	5 JA ; 5 KB	-		157	655	305	1978	HD	8	TT	80 A6	30	3.85	450
7 - 14	5 JA ; 5 KB	-		170	690	320	2070	STD	4	TT	72 A6	30	1.60	355
7 - 14	5 JA ; 5 KB	-		170	690	320	2070	STD	4	TL	72 A6	30	1.60	355
7 - 14	5 JA ; 5 KB	-		170	690	320	2070	STD	8	TT	95 A6	30	4.00	690

Performance



High Load Capacity



Traction





TRACTOR

Bias



TR 128

TR 128 has been specially designed for utility tractors and rototillers. The wide and deep lug design and the special cut-and-chip resistance compound provide an extended tire service life. TR 128 features maximum traction on wet soil.

Ø 12"	Tire size	RIM		S.W. (mm)	O.D. (mm)	SLR (mm)	RC (mm)	Version	PR	Type	LI/SS	Load capacity (kg/tire)	
		Rec.	Alt.									km/h - bar	
Ø 12"	180/85 D 12	5 JA	-	165	612	295	1847	STD	6	TT	76 A6	30	2.40
	180/85 D 12	5 JA	-	165	612	295	1847	STD	4	TT	63 A6	30	1.60
	5 - 12	4 JA	-	127	554	262	1700	STD	4	TT	-	30	2.40
	5 - 12	4 JA	-	127	554	262	1700	STD	6	TT	64 A6	30	3.50
	6.00 - 12	4.00 E	4.00 EDT	160	635	296	1926	STD	8	TT	82 A6	30	3.40
	6.00 - 12	4.00 E	4.00 EDT	160	635	296	1926	STD	4	TT	69 A6	30	1.80
	6.00 - 12	4.00 E	4.00 EDT	160	635	296	1926	STD	6	TT	76 A6	30	2.60
	7 - 14	5 JA	5 J	173	690	323	2086	STD	8	TT	95 A6	30	4.00

Performance



Cut and Chip Resistance



High Load Capacity



Traction

STD: Standard





TRACTOR

Bias



TR 133 (R-1)

TR 133 has been specially designed for tractors in soil tillage applications. Thanks to the increased number of lugs, this tire features excellent traction as well as enhanced self-cleaning properties. TR 133 provides an extended tire life-cycle.

Ø 38"	Tire size	RIM		S.W. (mm)	O.D. (mm)	SLR (mm)	RC (mm)	Version	PR	Type	LI/SS	Load capacity (kg/tire)	
		Rec.	Alt.									km/h - bar	
	13.6 - 38 (14.00 - 38)	W 12	W 11	350	1580	735	4843	STD	10	TT	136 A6	30	2240

STD: Standard

Technologies



More Lugs

Performance



Durability



High Load Capacity



Self-Cleaning



Traction





TRACTOR

Bias



TR 135 (R-1)

TR 135 is best suitable for tractors in soil tillage applications. Its reinforced casing and the special cut-and-chip resistance compound provide an extended tire life-cycle. Traction, self-cleaning proprieties and load capacity are key features which make the TR 135 tire the ideal partner even on the most difficult ground conditions.

Ø 16"	Tire size	RIM		S.W. (mm)	O.D. (mm)	SLR (mm)	RC (mm)	Version	PR	Type	LI/SS	Load capacity (kg/tire)		
		Rec.	Alt.									km/h - bar		
12.4 - 16	W 11	W 9; 9; W 10	326	960	431	2852	STD	4	TT	97 A6		30	1.20	
													730	
12.4 - 16	W 11	W 9; 9; W 10	326	960	431	2852	STD	8	TT	111 A6		30	2.20	
													1090	
Ø 20"	8.00 - 20	5.50 F	-	225	965	448	2837	STD	6	TT	105 A6		30	2.10
														925
8.00 - 20	5.50 F	-	225	965	448	2837	STD	8	TT	111 A6		30	2.80	
													1090	
9.5 - 20	W 8	W 7	240	955	444	2881	STD	6	TT	102 A6		30	2.20	
													850	
9.5 - 20	W 8	W 7	240	955	454	2888	STD	8	TT	107 A6		30	2.80	
													975	
9.5 - 20	W 8	W 7	240	955	454	2888	HD	8	TT	107 A6		30	2.80	
													975	
10.00 - 20	7.5	-	280	1075	495	3160	STD	10	TT	152 A2		10	4.80	
													3550	
11.2 - 20	W 10	W 9; 9	292	1020	466	3077	STD	8	TT	111 A6		30	2.40	
													1090	
12.4 - 20	W 11	W 9; 9; W 10; 11	325	1075	500	3160	STD	8	TT	116 A6		30	2.10	
													1250	
12.4 - 20	W 11	W 9; 9; W 10; 11	325	1075	500	3160	HD	8	TT	116 A6		30	2.10	
													1250	

Technologies



Reinforced Carcass



Special Compound

Performance



Cut and Chip Resistance



Durability



High Load Capacity



Self-Cleaning



Traction

STD: Standard - HD: Heavy Duty





TR 135 (R-1)

Ø 24"	Tire size	RIM		S.W. (mm)	O.D. (mm)	SLR (mm)	RC (mm)	Version	PR	Type	LI/SS	Load capacity (kg/tire)	
		Rec.	Alt.									km/h - bar	
8.3 - 24	W 7	W 6	211	995	469	2985	STD	6	TT	100 A6	30	800	2.40
8.3 - 24	W 7	W 6	211	995	475	3076	STD	8	TT	105 A6	30	925	3.10
8.3 - 24	W 7	W 6	211	995	469	2985	HD	8	TT	105 A6	30	925	3.10
8.3 - 24	W 7	W 6	211	995	469	2985	HD	10	TT	111 A6	30	1090	4.00
9.5 - 24	W 8	W 7	241	1060	502	3234	STD	6	TT	106 A6	30	950	2.10
9.5 - 24	W 8	W 7	241	1060	502	3234	STD	8	TT	112 A6	30	1120	2.80
9.5 - 24	W 8	W 7	241	1060	502	3234	STD	10	TT	116 A6	30	1250	3.50
9.5 - 24	W 8	W 7	241	1060	502	3234	HD	8	TT	112 A6	30	1120	2.80
9.5 - 24	W 8	W 7	241	1060	502	3234	HD	10	TT	116 A6	30	1250	3.50
11.2 - 24	W 10	W 9	284	1105	517	3399	STD	6	TT	110 A6	30	1060	1.80
11.2 - 24	W 10	W 9	284	1105	517	3399	STD	8	TT	116 A6	30	1250	2.40
11.2 - 24	W 10	W 9	284	1105	517	3399	STD	8	TL	116 A6	30	1250	2.40
11.2 - 24	W 10	W 9	284	1105	517	3399	HD	10	TL	120 A6	30	1400	3.00

Technologies



Reinforced Carcass



Special Compound

Performance



Cut and Chip Resistance



Durability



High Load Capacity



Self-Cleaning



Traction

STD: Standard - HD: Heavy Duty





TRACTOR

TR 135 (R-1)

Ø 24"	Tire size	RIM		S.W. (mm)	O.D. (mm)	SLR (mm)	RC (mm)	Version	PR	Type	LI/SS	Load capacity (kg/tire)		
		Rec.	Alt.									km/h - bar		
11.2 - 24	W 10	W 9	284	1105	507	3303	HD	8	TT	116 A6		30	2.40	1250
11.2 - 24	W 10	W 9	284	1105	517	3399	HD	10	TT	120 A6		30	3.00	1400
12.4 - 24	W 11	W 9; W 10	315	1160	543	3573	STD	8	TT	121 A6		30	2.30	1450
12.4 - 24	W 11	W 9; W 10	315	1160	543	3573	STD	8	TL	121 A6		30	2.30	1450
12.4 - 24	W 11	W 9; W 10	315	1160	543	3573	STD	6	TT	115 A6		30	1.70	1215
12.4 - 24	W 11	W 9; W 10	315	1160	543	3573	STD	10	TT	125 A6		30	2.90	1650
12.4 - 24	W 11	W 9; W 10	315	1160	543	3573	STD	12	TT	128 A6		30	3.50	1800
12.4 - 24	W 11	W 9; W 10	315	1160	543	3573	STD	12	TL	128 A6		30	3.50	1800
12.4 - 24	W 11	W 9; W 10	315	1160	531	3477	HD	8	TT	121 A6		30	2.30	1450
12.4 - 24	W 11	W 9; W 10	315	1160	531	3477	HD	8	TL	121 A6		30	2.30	1450
12.4 - 24	W 11	W 9; W 10	315	1160	543	3573	SPL	12	TT	128 A6		30	3.50	1800
13.6 - 24	W 12	W 11	355	1220	562	3698	STD	12	TT	130 A6		30	2.90	1900
13.6 - 24	W 12	W 11	355	1220	562	3698	STD	8	TT	123 A6		30	2.00	1550

Technologies



Reinforced Carcass



Special Compound

Performance



Cut and Chip Resistance



Durability



High Load Capacity



Self-Cleaning



Traction

STD: Standard - HD: Heavy Duty - SPL: Special





TRACTOR

TR 135 (R-1)

Ø 24"	Tire size	RIM		S.W. (mm)	O.D. (mm)	SLR (mm)	RC (mm)	Version	PR	Type	LI/SS	Load capacity (kg/tire)	
		Rec.	Alt.									km/h - bar	2.00
13.6 - 24	W 12	W 11	355	1220	562	3698	STD	8	TL	123 A6	30	1550	
13.6 - 24	W 12	W 11	355	1220	562	3698	HD	12	TT	130 A6	30	1900	
13.6 - 24	W 12	W 11	355	1220	562	3698	HD	8	TT	123 A6	30	1550	
14.9 - 24	W 13	W 12; W 11	378	1265	576	3837	STD	12	TT	135 A6	30	2180	
14.9 - 24	W 13	W 12; W 11	378	1265	576	3837	STD	12	TL	135 A6	30	2180	
14.9 - 24	W 13	W 12; W 11	378	1265	576	3837	STD	8	TT	128 A6	30	1800	
14.9 - 24	W 13	W 12; W 11	378	1265	576	3837	STD	8	TL	128 A6	30	1800	
14.9 - 24	W 13	W 11; W 12	378	1265	570	3769	HD	8	TT	128 A6	30	1800	
14.9 - 24	W 13	W 11; W 12	378	1265	576	3837	HD	10	TL	132 A6	30	2000	
14.9 - 24	W 13	W 12; W 11	378	1265	576	3837	HD	12	TT	135 A6	30	2180	
14.9 - 24	W 13	W 12; W 11	378	1265	570	3769	HD	8	TL	128 A6	30	1800	
16.9 - 24	W 15 L	W 14 L	429	1335	613	3925	STD	8	TL	133 A6	30	2060	
16.9 - 24	W 15 L	W 14 L	429	1335	613	3925	STD	10	TL	136 A6	30	2240	
16.9 - 24	W 15 L	W 14 L	429	1335	613	3925	STD	8	TT	133 A6	30	2060	

Technologies



Reinforced Carcass



Special Compound

Performance



Cut and Chip Resistance



Durability



High Load Capacity



Self-Cleaning



Traction

STD: Standard - HD: Heavy Duty





TR 135 (R-1)

Ø 24"	Tire size	RIM		S.W. (mm)	O.D. (mm)	SLR (mm)	RC (mm)	Version	PR	Type	LI/SS	Load capacity (kg/tire)	
		Rec.	Alt.									km/h - bar	
												2.00	
	16.9 - 24	W 15 L	W 14 L	429	1335	613	3925	STD	10	TT	136 A6	30	2240
	16.9 - 24	W 15 L	W 14 L	429	1335	613	3925	HD	8	TT	133 A6	30	2060
	16.9 - 24	W 15 L	W 14 L	429	1335	613	3925	HD	12	TT	140 A6	30	2500
												1.80	
	14.9 - 26	W 13	W 11; W 12	375	1315	608	3863	STD	8	TT	129 A6	30	1850
	14.9 - 26	W 13	W 11; W 12	375	1315	608	3863	STD	12	TT	136 A6	30	2240
	14.9 - 26	W 13	W 11; W 12	375	1315	608	3863	HD	8	TT	129 A6	30	1850
	16.9 - 26	W 15 L	W 14 L	430	1380	625	4183	STD	10	TT	137 A6	30	2300
	16.9 - 26	W 15 L	W 14 L	430	1380	625	4183	STD	12	TT	140 A6	30	2500
	16.9 - 26	W 15 L	W 14 L	430	1380	625	4183	STD	10	TL	137 A6	30	2300
	23.1 - 26	DW 20 B; DW 20 A	-	587	1585	700	4615	STD	12	TL	153 A6	30	3650
	23.1 - 26	DW 20 B; DW 20 A	-	587	1585	700	4615	STD	12	TT	153 A6	30	3650
	23.1 - 26	DW 20 B; DW 20 A	-	587	1585	700	4615	STD	14	TL	156 A6	30	4000
	23.1 - 26	DW 20 B; DW 20 A	-	587	1585	700	4615	STD	16	TL	159 A6	30	4375

Technologies



Reinforced Carcass



Special Compound

Performance



Cut and Chip Resistance



Durability



High Load Capacity



Self-Cleaning



Traction

STD: Standard - HD: Heavy Duty





TRACTOR

TR 135 (R-1)

Ø 26"	Tire size	RIM		S.W. (mm)	O.D. (mm)	SLR (mm)	RC (mm)	Version	PR	Type	LI/SS	Load capacity (kg/tire)	
		Rec.	Alt.									km/h - bar	2.30
Ø 26"	23.1 - 26	DW 20 B ; DW 20 A	-	587	1585	700	4615	STD	16	TT	159 A6	30	4375
	23.1 - 26	DW 20 B ; DW 20 A	-	587	1585	700	4615	DB	12	TL	153 A6	30	3650
	23.1 - 26	DW 20 B ; DW 20 A	-	587	1585	700	4615	DB	16	TL	159 A6	30	4375
	23.1 - 26	DW 20 B ; DW 20 A	-	587	1585	700	4615	DB	18	TL	161 A6	30	4625
	23.1 - 26	DW 20 B ; DW 20 A	-	587	1585	700	4615	DB	12	TT	153 A6	30	3650
	23.1 - 26	DW 20 B ; DW 20 A	-	587	1585	700	4615	DB HD	16	TL	159 A6	30	4375
	23.1 - 26	DW 20 B ; DW 20 A	-	587	1585	700	4615	HD	16	TT	159 A6	30	4375
	23.1 - 26	DW 20 B ; DW 20 A	-	587	1585	700	4615	HD	16	TT	159 A6	30	4375
Ø 28"	8.3 - 28	W 7	W 6	213	1104	519	3347	STD	6	TT	103 A6	30	875
	8.3 - 28	W 7	W 6	213	1104	519	3347	STD	8	TT	108 A6	30	1000
	9.5 - 28	W 8	W 7	235	1155	548	3557	STD	6	TT	108 A6	30	1000
	9.5 - 28	W 8	W 7	235	1155	548	3557	STD	8	TT	114 A6	30	1180
	11.2 - 28	W 10	W 9	284	1205	565	3543	STD	8	TT	118 A6	30	1320
	11.2 - 28	W 10	W 9	284	1205	565	3543	STD	10	TT	122 A6	30	1500

STD: Standard - HD: Heavy Duty - DB: Dual Bead - DB HD: Dual Bead HD

Technologies



Reinforced Carcass



Special Compound

Performance



Cut and Chip Resistance



Durability



High Load Capacity



Self-Cleaning



Traction



TRACTOR

TR 135 (R-1)

Ø 28"	Tire size	RIM		S.W. (mm)	O.D. (mm)	SLR (mm)	RC (mm)	Version	PR	Type	LI/SS	Load capacity (kg/tire)		
		Rec.	Alt.									km/h - bar		
	11.2 - 28	W 10	W 9	284	1205	565	3543	HD	8	TT	118 A6	30	2.40	1320
	12.4 - 28	W 11	W 9; W 10	325	1260	584	3876	STD	10	TT	127 A6	30	2.90	1750
	12.4 - 28	W 11	W 9; W 10	325	1260	584	3876	STD	12	TT	131 A6	30	3.50	1950
	12.4 - 28	W 11	W 9; W 10	325	1260	584	3876	STD	6	TT	117 A6	30	1.70	1285
	12.4 - 28	W 11	W 9; W 10	325	1260	584	3876	STD	8	TT	123 A6	30	2.30	1550
	12.4 - 28	W 11	W 9; W 10	325	1260	584	3876	HD	8	TT	123 A6	30	2.30	1550
	13.6 - 28	W 12	W 11	345	1310	606	3908	STD	8	TT	125 A6	30	2.00	1650
	13.6 - 28	W 12	W 11	345	1310	606	3908	STD	12	TT	134 A6	30	3.00	2120
	13.6 - 28	W 12	W 11	345	1310	606	3908	STD	14	TT	137 A6	30	3.50	2300
	13.6 - 28	W 12	W 11	345	1310	606	3908	HD	8	TT	125 A6	30	2.00	1650
	14.9 - 28	W 13	W 11; W 12	378	1365	634	4170	STD	6	TT	125 A6	30	1.40	1650
	14.9 - 28	W 13	W 11; W 12	378	1365	634	4170	STD	8	TT	130 A6	30	1.80	1900
	14.9 - 28	W 13	W 11; W 12	378	1365	634	4170	STD	12	TT	137 A6	30	2.60	2300

Technologies



Reinforced Carcass



Special Compound

Performance



Cut and Chip Resistance



Durability



High Load Capacity



Self-Cleaning



Traction

STD: Standard - HD: Heavy Duty





TR 135 (R-1)

Ø 28"	Tire size	RIM		S.W. (mm)	O.D. (mm)	SLR (mm)	RC (mm)	Version	PR	Type	LI/SS	Load capacity (kg/tire)		
		Rec.	Alt.									km/h - bar		
14.9 - 28	W 13	W 11; W 12	378	1365	634	4170	STD	14	TT	139 A6		km/h - bar	2.90	
												30	2430	
14.9 - 28	W 13	W 11; W 12	378	1365	634	4170	STD	8	TL	130 A6		km/h - bar	1.80	
												30	1900	
14.9 - 28	W 13	W 11; W 12	378	1365	634	4170	HD	12	TT	137 A6		km/h - bar	2.60	
												30	2300	
14.9 - 28	W 13	W 11; W 12	378	1365	634	4170	HD	8	TT	130 A6		km/h - bar	1.80	
												30	1900	
18.4 - 28	W 16 L	W 15 L	467	1501	691	4413	STD	8	TL	138 A6		km/h - bar	1.70	
												30	2360	
18.4 - 28	W 16 L	W 15 L	467	1501	691	4413	STD	12	TL	147 A6		km/h - bar	2.50	
												30	3075	
Ø 30"	7.2 - 30	W 6	-	185	1095	523	3219	STD	6	TT	95 A6		km/h - bar	2.30
													30	690
	9.5 - 30	W 8	W 7	241	1200	567	3528	STD	8	TT	115 A6		km/h - bar	2.80
													30	1215
	9.5 - 30	W 8	W 7	241	1200	567	3528	STD	6	TT	109 A6		km/h - bar	2.10
													30	1030
	14.9 - 30	W 13	W 11; W 12	378	1415	659	4316	STD	8	TT	131 A6		km/h - bar	1.80
												30	1950	
15 - 30 (18.4 - 30)	W 16 L	W 15 L	460	1545	714	4542	STD	12	TT	149 A6		km/h - bar	2.30	
												30	3250	
15 - 30 (18.4 - 30)	W 16 L	W 15 L	460	1545	714	4542	STD	14	TT	151 A6		km/h - bar	2.60	
												30	3450	

STD: Standard - HD: Heavy Duty

Technologies



Reinforced Carcass



Special Compound

Performance



Cut and Chip Resistance



Durability



High Load Capacity



Self-Cleaning



Traction





TRACTOR

TR 135 (R-1)

Ø 30"	Tire size	RIM		S.W. (mm)	O.D. (mm)	SLR (mm)	RC (mm)	Version	PR	Type	LI/SS	Load capacity (kg/tire)		
		Rec.	Alt.									km/h - bar		
	16.9 - 30	W 15 L	W 14 L	429	1485	678	4535	STD	8	TT	137 A6	30	1.70	2300
	16.9 - 30	W 15 L	W 14 L	429	1485	678	4535	STD	10	TT	139 A6	30	2.00	2430
	16.9 - 30 (14 - 30)	W 15 L	W 14 L	429	1485	678	4535	STD	14	TT	146 A6	30	2.80	3000
	16.9 - 30 (14 - 30)	W 15 L	W 14 L	429	1485	678	4535	STD	16	TT	149 A6	30	3.20	3250
	18.4 - 30	W 16 L	W 15 L	460	1545	697	4712	STD	16	TT	154 A6	30	2.90	3750
	18.4 - 30	W 16 L	W 15 L	460	1545	697	4712	STD	12	TL	149 A6	30	2.30	3250
	18.4 - 30	W 16 L	W 15 L	460	1545	697	4712	STD	14	TT	151 A6	30	2.60	3450
	18.4 - 30	W 16 L	W 15 L	460	1545	697	4712	STD	8	TT	139 A6	30	1.40	2430
	18.4 - 30	W 16 L	W 15 L	460	1545	697	4712	STD	10	TT	145 A6	30	1.80	2900
	18.4 - 30	W 16 L	W 15 L	460	1545	697	4712	STD	12	TT	149 A6	30	2.30	3250
	18.4 - 30	W 16 L	W 15 L	460	1545	697	4712	HD	8	TT	139 A6	30	1.40	2430
	18.4 - 30	W 16 L	W 15 L	460	1545	697	4712	HD	10	TT	145 A6	30	1.80	2900
	18.4 - 30	W 16 L	W 15 L	460	1545	697	4712	HD	10	TL	145 A6	30	1.80	2900

Technologies



Reinforced Carcass



Special Compound

Performance



Cut and Chip Resistance



Durability



High Load Capacity



Self-Cleaning



Traction

STD: Standard - HD: Heavy Duty





TRACTOR

TR 135 (R-1)

Ø 30"	Tire size	RIM		S.W. (mm)	O.D. (mm)	SLR (mm)	RC (mm)	Version	PR	Type	LI/SS	Load capacity (kg/tire)	
		Rec.	Alt.									km/h - bar	
													2.30
Ø 30"	18.4 - 30	W 16 L	W 15 L	460	1545	697	4712	HD	12	TT	149 A6	30	3250
	23.1 - 30	DW 20 B ; DW 20 A	-	600	1700	773	5217	STD	12	TL	155 A6	km/h - bar	1.70
												30	3875
	23.1 - 30	DW 20 B ; DW 20 A	-	600	1700	773	5217	STD	8	TT	146 A6	km/h - bar	1.10
												30	3000
	23.1 - 30	DW 20 B ; DW 20 A	-	600	1700	773	5217	STD	8	TL	146 A6	km/h - bar	1.10
												30	3000
	23.1 - 30	DW 20 B ; DW 20 A	-	600	1700	773	5217	STD	12	TT	155 A6	km/h - bar	1.70
30												3875	
23.1 - 30	DW 20 B ; DW 20 A	-	600	1700	773	5217	DB	12	TT	155 A6	km/h - bar	1.70	
											30	3875	
23.1 - 30	DW 20 B ; DW 20 A	-	600	1700	773	5217	DB	18	TT	164 A6	km/h - bar	2.60	
											30	5000	
23.1 - 30	DW 20 B ; DW 20 A	-	600	1700	773	5217	DB	18	TL	164 A6	km/h - bar	2.60	
											30	5000	
Ø 32"	8.3 - 32	W 7	W 6	211	1195	572	3585	STD	6	TT	105 A6	km/h - bar	2.40
	8.3 - 32	W 7	W 6	211	1195	572	3585	STD	8	TT	111 A6	30	925
												km/h - bar	3.20
	9.5 - 32	W 8	W 7	235	1255	594	3686	STD	6	TT	110 A6	km/h - bar	2.10
												30	1060
	11.2 - 32	W 10	W 9	287	1310	615	4007	STD	8	TL	120 A6/ 116 A8	km/h - bar	2.40
												30	1400
12.4 - 32	W 11	W 9 ; W 10	325	1360	639	3998	STD	8	TT	124 A6	km/h - bar	2.30	
											30	1600	
12.4 - 32	W 11	W 9 ; W 10	325	1360	639	3998	STD	6	TT	119 A6	km/h - bar	1.70	
											30	1360	

Technologies



Reinforced Carcass



Special Compound

Performance



Cut and Chip Resistance



Durability



High Load Capacity



Self-Cleaning



Traction

STD: Standard - HD: Heavy Duty - DB: Dual Bead



TR 135 (R-1)

Ø 32"	Tire size	RIM		S.W. (mm)	O.D. (mm)	SLR (mm)	RC (mm)	Version	PR	Type	LI/SS	Load capacity (kg/tire)	
		Rec.	Alt.									km/h - bar	
												2.30	
	12.4 - 32	W 11	W 9; W 10	325	1360	639	3998	HD	8	TT	124 A6	30	1600
	12.4 - 32	W 11	W 9; W 10	325	1360	639	3998	HD	10	TT	128 A6	30	1800
												2.80	
												1.70	
	16.9 - 34	W 15 L	W 14 L	429	1585	728	4794	STD	8	TT	139 A6	30	2430
	16.9 - 34	W 15 L	W 14 L	429	1585	728	4794	STD	10	TT	142 A6	30	2650
	16.9 - 34	W 15 L	W 14 L	429	1585	728	4794	STD	12	TT	144 A6	30	2800
	16.9 - 34	W 15 L	W 14 L	429	1585	728	4794	HD	14	TT	142 A6	30	3000
	16.9 - 34	W 15 L	W 14 L	429	1585	728	4794	HD	8	TT	139 A6	30	2430
	16.9 - 34	W 15 L	W 14 L	429	1585	728	4794	HD	10	TT	142 A6	30	2650
	16.9 - 34	W 15 L	W 14 L	429	1585	728	4794	HD	12	TT	144 A6	30	2800
	18.4 - 34	W 16 L	W 15 L	467	1650	751	5009	STD	6	TT	137 A6	30	2300
	18.4 - 34	W 16 L	W 15 L	467	1650	751	5009	STD	8	TT	142 A6	30	2650
	18.4 - 34	W 16 L	W 15 L	467	1650	751	5009	STD	14	TT	154 A6	30	3750
	18.4 - 34	W 16 L	W 15 L	467	1650	751	5009	STD	10	TT	146 A6	30	3000

Technologies



Reinforced Carcass



Special Compound

Performance



Cut and Chip Resistance



Durability



High Load Capacity



Self-Cleaning



Traction

STD: Standard - HD: Heavy Duty





TRACTOR

TR 135 (R-1)

Ø 34"	Tire size	RIM		S.W. (mm)	O.D. (mm)	SLR (mm)	RC (mm)	Version	PR	Type	LI/SS	Load capacity (kg/tire)	
		Rec.	Alt.									km/h - bar	
18.4 - 34	W 16 L	W 15 L	467	1650	751	5009	STD	12	TT	151 A6		30	2.30
													3450
18.4 - 34	W 16 L	W 15 L	467	1650	751	5009	HD	8	TT	142 A6		30	1.40
													2650
18.4 - 34	W 16 L	W 15 L	467	1650	751	5009	HD	10	TT	146 A6		30	1.80
													3000
18.4 - 34	W 16 L	W 15 L	467	1650	751	5009	HD	12	TT	151 A6		30	2.30
													3450
18.4 - 34	W 16 L	W 15 L	467	1650	751	5009	HD	14	TT	154 A6		30	2.60
													3750
18.4 - 34	W 16 L	W 15 L	467	1650	751	5009	HD SPL	12	TT	151 A6		30	2.30
													3450
23.1 - 34	DW 20 B ; DW 20 A	-	585	1810	834	5321	STD	10	TT	153 A6		30	1.40
													3650
23.1 - 34	DW 20 B ; DW 20 A	-	585	1810	834	5321	STD	10	TL	153 A6		30	1.40
													3650

Ø 36"	Tire size	RIM	S.W. (mm)	O.D. (mm)	SLR (mm)	RC (mm)	Version	PR	Type	LI/SS	Load capacity (kg/tire)		
											km/h - bar		
8.3 - 36	W 7	W 6	211	1295	628	4028	STD	6	TT	107 A6		30	2.40
													975
8.3 - 36	W 7	W 6	211	1295	628	4028	STD	8	TT	113 A6		30	3.20
													1150
9.5 - 36	W 8	W 7	235	1360	646	4000	STD	10	TT	122 A6		30	3.50
													1500
12.4 - 36	W 11	W 9 ; W 10	325	1465	696	4546	STD	8	TT	126 A6		30	2.30
													1700
12.4 - 36	W 11	W 9 ; W 10	325	1465	696	4546	STD	10	TT	131 A6		30	2.90
													1950

Technologies



Reinforced Carcass



Special Compound

Performance



Cut and Chip Resistance



Durability



High Load Capacity



Self-Cleaning



Traction

STD: Standard - HD: Heavy Duty - HD SPL: HD Special



TR 135 (R-1)

Ø 36"	Tire size	RIM		S.W. (mm)	O.D. (mm)	SLR (mm)	RC (mm)	Version	PR	Type	LI/SS	Load capacity (kg/tire)		
		Rec.	Alt.									km/h - bar		
12.4 - 36	W 11	W 9; W 10	325	1465	696	4546	STD	12	TT	135 A6		3.50		
												30	2180	
12.4 - 36	W 11	W 9; W 10	325	1465	696	4546	STD	14	TT	139 A6		4.10		
												30	2430	
12.4 - 36	W 11	W 9; W 10	325	1465	696	4546	HD	8	TT	126 A6		2.30		
												30	1700	
12.4 - 36	W 11	W 9; W 10	325	1465	696	4546	HD	10	TT	131 A6		2.90		
												30	1950	
12.4 - 36	W 11	W 9; W 10	325	1465	696	4546	HD	12	TT	135 A6		3.50		
												30	2180	
12.4 - 36	W 11	W 9; W 10	325	1465	696	4546	HD	14	TL	139 A6		4.10		
												30	2430	
12.4 - 36	W 11	W 9; W 10	325	1465	696	4546	HD	14	TT	139 A6		4.10		
												30	2430	
13.6 - 36	W 12	W 11	345	1515	713	4454	STD	10	TT	134 A6		2.50		
												30	2120	
13.6 - 36	W 12	W 11	345	1515	713	4454	STD	6	TT	125 A6		1.60		
												30	1650	
13.6 - 36	W 12	W 11	345	1515	713	4454	STD	8	TT	129 A6		2.00		
												30	1850	
13.6 - 36	W 12	W 11	345	1515	713	4454	HD	10	TT	134 A6		2.50		
												30	2120	
Ø 38"	11.2 - 38	W 10	W 9	284	1460	-	-	STD	6	TL	117 A6		1.80	
													30	1285
12.4 - 38	W 11	W 9; W 10	325	1525	718	4670	STD	8	TT	127 A6		2.30		
												30	1750	

Technologies



Reinforced Carcass



Special Compound

Performance



Cut and Chip Resistance



Durability



High Load Capacity



Self-Cleaning



Traction

STD: Standard - HD: Heavy Duty





Ø 38"	Tire size	RIM		S.W. (mm)	O.D. (mm)	SLR (mm)	RC (mm)	Version	PR	Type	LI/SS	Load capacity (kg/tire)	
		Rec.	Alt.									km/h - bar	
12.4 - 38	W 11	W 9; W 10	325	1525	718	4670	STD	14	TT	138 A6		3.70	2360
12.4 - 38	W 11	W 9; W 10	325	1525	718	4670	STD	14	TL	138 A6		3.70	2360
13.6 - 38 (14.00 - 38)	W 12	W 11	345	1565	735	4832	STD	12	TT	139 A6		3.00	2430
13.6 - 38 (14.00 - 38)	W 12	W 11	345	1565	735	4832	STD	14	TT	142 A6		3.50	2650
13.6 - 38 (14.00 - 38)	W 12	W 11	345	1565	735	4832	STD	8	TT	131 A6		2.00	1950
13.6 - 38 (14.00 - 38)	W 12	W 11	345	1565	735	4832	HD	8	TT	131 A6		2.00	1950
13.6 - 38 (14.00 - 38)	W 12	W 11	345	1565	735	4832	HD	12	TT	139 A6		3.00	2430
14.00 - 38 (13.6 - 38)	W 12	W 11	345	1565	735	4832	STD	8	TT	131 A6		2.00	1950
14.00 - 38 (13.6 - 38)	W 12	W 11	345	1565	735	4832	SPL	12	TT	139 A6		3.00	2430
15.5 - 38	W 14 L	-	395	1585	746	4660	STD	12	TT	141 A6		2.80	2575
15.5 - 38	W 14 L	-	395	1585	746	4660	STD	10	TT	138 A6		2.30	2360
15.5 - 38	W 14 L	-	395	1585	746	4660	STD	8	TT	133 A6		1.80	2060
15.5 - 38	W 14 L	-	395	1585	746	4660	HD	8	TT	133 A6		1.80	2060

STD: Standard - HD: Heavy Duty - SPL: Special

Technologies



Reinforced Carcass



Special Compound

Performance

Cut and Chip
Resistance

Durability



High Load Capacity



Self-Cleaning



Traction



TR 135 (R-1)

Ø 38"	Tire size	RIM		S.W. (mm)	O.D. (mm)	SLR (mm)	RC (mm)	Version	PR	Type	LI/SS	Load capacity (kg/tire)	
		Rec.	Alt.									km/h - bar	
15.5 - 38	W 14 L	-	395	1585	746	4760	HD	10	TT	138 A6		30	2360
15.5 - 38	W 14 L	-	395	1585	746	4660	HD	8	TL	133 A6		30	2060
16.9 - 38	W 15 L	W 14 L	429	1685	788	4954	STD	10	TT	143 A6		30	2725
16.9 - 38	W 15 L	W 14 L	429	1685	788	4954	STD	12	TT	146 A6		30	3000
16.9 - 38	W 15 L	W 14 L	429	1685	788	4954	STD	8	TT	141 A6		30	2575
16.9 - 38	W 15 L	W 14 L	429	1685	788	4954	HD	8	TT	141 A6		30	2575
16.9 - 38	W 15 L	W 14 L	429	1685	788	4954	HD	10	TT	143 A6		30	2725
18.4 - 38	W 16 L	W 15 L	467	1750	794	5366	STD	8	TT	143 A6		30	2725
18.4 - 38	W 16 L	W 15 L	467	1750	794	5366	STD	12	TT	153 A6		30	3650
18.4 - 38	W 16 L	W 15 L	467	1750	794	5366	STD	14	TT	155 A6		30	3875
18.4 - 38	W 16 L	W 15 L	467	1750	794	5366	STD	12	TL	153 A6		30	3650
18.4 - 38	W 16 L	W 15 L	467	1750	794	5366	HD	8	TT	143 A6		30	2725
18.4 - 38	W 16 L	W 15 L	467	1750	794	5366	HD	10	TT	148 A6		30	3150

Technologies



Reinforced Carcass



Special Compound

Performance



Cut and Chip Resistance



Durability



High Load Capacity



Self-Cleaning



Traction

STD: Standard - HD: Heavy Duty





TR 135 (R-1)

Ø 38"	Tire size	RIM		S.W. (mm)	O.D. (mm)	SLR (mm)	RC (mm)	Version	PR	Type	LI/SS	Load capacity (kg/tire)	
		Rec.	Alt.									km/h - bar	1.80
18.4 - 38	W 16 L	W 15 L	467	1750	794	5366	HD	10	TL	148 A6	30	3150	
18.4 - 38	W 16 L	W 15 L	467	1750	794	5366	HD	12	TT	153 A6	30	3650	
20.8 - 38	W 18 L	W 16 L	530	1835	852	5395	STD	12	TT	156 A6	30	4000	
20.8 - 38	W 18 L	W 16 L	530	1835	852	5395	STD	14	TT	160 A6	30	4500	
20.8 - 38	W 18 L	W 16 L	530	1835	852	5395	STD	8	TT	148 A6	30	3150	
20.8 - 38	W 18 L	W 16 L	530	1835	852	5395	STD	12	TL	156 A6	30	4000	
20.8 - 38	W 18 L	W 16 L	530	1835	852	5395	DB HD	18	TT	166 A6	30	5300	
20.8 - 38	W 18 L	W 16 L	530	1835	852	5395	DB HD	18	TL	166 A6	30	5300	
20.8 - 38	W 18 L	W 16 L	530	1835	852	5395	DB HD	16	TT	163 A6	30	4875	
20.8 - 38	W 18 L	W 16 L	530	1835	852	5395	HD	12	TT	156 A6	30	4000	
Ø 42"	9.5 - 42	W 8	W 7	246	1510	721	4663	STD	10	TT	125 A6	30	1650
	12.4 - 42	W 10 ; W 10 A	-	322	1630	770	5011	STD	10	TL	134 A6	30	2120
	20.8 - 42	W 18 L	W 16 L	535	1950	909	5733	STD	12	TL	158 A6	30	4250

Technologies



Reinforced Carcass



Special Compound

Performance



Cut and Chip Resistance



Durability



High Load Capacity



Self-Cleaning



Traction

STD: Standard - HD: Heavy Duty - DB HD: Dual Bead HD



TRACTOR

TR 135 (R-1)

Ø 42"	Tire size	RIM		S.W. (mm)	O.D. (mm)	SLR (mm)	RC (mm)	Version	PR	Type	LI/SS	Load capacity (kg/tire)		
		Rec.	Alt.									km/h - bar		
	20.8 - 42	W 18 L	W 16 L	535	1950	909	5733	STD	16	TL	165 A6	30	2.80	5150
	20.8 - 42	W 18 L	W 16 L	535	1950	909	5733	STD	12	TT	158 A6	30	2.00	4250
	20.8 - 42	W 18 L	W 16 L	535	1950	909	5733	DB HD	18	TL	168 A6	30	3.20	5600

STD: Standard - DB HD: Dual Bead HD

Technologies



Reinforced Carcass



Special Compound

Performance



Cut and Chip Resistance



Durability



High Load Capacity



Self-Cleaning



Traction





TRACTOR

Bias



TR 136 (R-1)

TR 136 has been developed by BKT to equip tractors and trailers in soil tillage and haulage operations. This tire provides improved traction in all working conditions along with best cut and chip resistance to reduce machine downtime and increase your productivity. Thanks to the increased number of lugs, TR 136 provides outstanding traction even at high loads.

Ø 26"	Tire size	RIM		S.W. (mm)	O.D. (mm)	SLR (mm)	RC (mm)	Version	PR	Type	LI/SS	Load capacity (kg/tire)	
		Rec.	Alt.									km/h - bar	
Ø 26"	18.4 - 26	W 16 L	W 15 L	480	1450	646	4205	STD	12	TL	146 A6	30	3000
	18.4 - 26	W 16 L	W 15 L	480	1450	646	4205	STD	12	TT	146 A6	30	3000
	18.4 - 26	W 16 L	W 15 L	480	1450	646	4205	STD	14	TL	150 A6	30	3350
	18.4 - 26	W 16 L	W 15 L	480	1450	646	4205	SPL	12	TL	146 A6	30	3000
Ø 28"	12.4 - 28	W 11	W 9; W 10	315	1275	595	3749	STD	8	TT	123 A6	30	1550
	16.9 - 30	W 15 L	W 14 L	429	1485	677	4455	STD	8	TT	137 A6	30	2300
Ø 30"	16.9 - 30	W 15 L	W 14 L	429	1485	677	4455	STD	10	TT	139 A6	30	2430
	16.9 - 30	W 15 L	W 14 L	429	1485	687	4523	STD	12	TT	143 A6	30	2725
	16.9 - 30 (14 - 30)	W 15 L	W 14 L	429	1485	677	4455	STD	14	TT	146 A6	30	3000
	16.9 - 30	W 15 L	W 14 L	429	1485	677	4455	HD	8	TT	137 A6	30	2300
	16.9 - 30	W 15 L	W 14 L	429	1485	677	4455	SPL	8	TT	137 A6	30	2300

Technologies



Performance



STD: Standard - HD: Heavy Duty - SPL: Special



TRACTOR

TR 136 (R-1)

Ø 30"	Tire size	RIM		S.W. (mm)	O.D. (mm)	SLR (mm)	RC (mm)	Version	PR	Type	LI/SS	Load capacity (kg/tire)	
		Rec.	Alt.									km/h - bar	
16.9 - 30	W 15 L	W 14 L	429	1485	687	4523	SPL	12	TT	143 A6		30	2725
												km/h - bar	2.40
16.9 - 30	W 15 L	W 14 L	429	1485	687	4523	SPL	12	TL	143 A6		30	2725
												km/h - bar	2.40
18.4 - 30	W 16 L	W 15 L	467	1550	712	4719	STD	8	TT	139 A6		30	2430
												km/h - bar	1.40
18.4 - 30	W 16 L	W 15 L	467	1550	712	4719	HD	8	TT	139 A6		30	2430
												km/h - bar	1.40
18.4 - 30	W 16 L	W 15 L	467	1550	712	4719	HD	12	TT	149 A6		30	3250
												km/h - bar	2.30
18.4 - 30	W 16 L	W 15 L	467	1550	712	4719	HD	14	TT	151 A6		30	3450
												km/h - bar	2.60
18.4 - 30	W 16 L	W 15 L	467	1550	712	4719	SPL	12	TT	149 A6		30	3250
												km/h - bar	2.30

STD: Standard - HD: Heavy Duty - SPL: Special

Technologies



Special Compound



More Lugs

Performance



Cut and Chip Resistance



Durability



High Load Capacity



Traction





TRACTOR

Bias



TR 144 (R-1)

TR 144 is suitable to equip small tractors to be used in soil tillage operations. TR 144 ensures outstanding performance in all operating conditions which require excellent traction with high loads. It is also available in a "special" version, which is best suitable for heavy-duty service.

Ø 16"	Tire size	RIM		S.W. (mm)	O.D. (mm)	SLR (mm)	RC (mm)	Version	PR	Type	LI/SS	Load capacity (kg/tire)	
		Rec.	Alt.									km/h - bar	
7 - 16	6 L; 6 LB; 6.00 F	-	183	740	344	2223	STD	4	TL	75 A6		km/h - bar	1.60
												30	387
7 - 16	6 L; 6 LB; 6.00 F	-	183	740	347	2253	STD	6	TT	84 A6		km/h - bar	2.50
												30	500
7 - 16	6 L; 6 LB; 6.00 F	-	183	740	344	2223	STD	4	TT	75 A6		km/h - bar	1.60
												30	387
8 - 16	6 L; 6 LB; 6.00 F	-	200	785	358	2342	STD	4	TT	83 A6		km/h - bar	1.20
												30	487
8 - 16	6 L; 6 LB; 6.00 F	-	200	785	358	2342	STD	6	TT	91 A6		km/h - bar	1.90
												30	615
8 - 16	6 L; 6 LB; 6.00 F	-	200	785	358	2342	STD	8	TT	98 A6		km/h - bar	2.60
												30	750
8 - 16	6 L; 6 LB; 6.00 F	-	200	785	358	2342	STD	6	TL	91 A6		km/h - bar	1.90
												30	615
8 - 16	6 L; 6 LB; 6.00 F	-	200	785	358	2342	HD	6	TT	91 A6		km/h - bar	1.90
												30	615
8 - 16	6 L; 6 LB; 6.00 F	-	200	785	358	2342	SPL	6	TT	91 A6		km/h - bar	1.90
												30	615
9.5 - 16	W 8 L	8 LB	245	850	388	2558	STD	6	TT	96 A6		km/h - bar	2.10
												30	710
9.5 - 16	W 8 L	8 LB	245	850	388	2558	STD	8	TT	102 A6		km/h - bar	2.80
												30	850

Performance



High Load Capacity



Traction

STD: Standard - HD: Heavy Duty - SPL: Special





TR 144 (R-1)

Ø 16"	Tire size	RIM		S.W. (mm)	O.D. (mm)	SLR (mm)	RC (mm)	Version	PR	Type	LI/SS	Load capacity (kg/tire)		
		Rec.	Alt.									km/h - bar	2.10	
9.5 - 16	W 8 L	8 LB	245	850	388	2558	STD	6	TL	96 A6		30	710	
9.5 - 16	W 8 L	8 LB	245	850	388	2558	STD	8	TL	102 A6		30	850	
Ø 18"	8 - 18	W 6	W 7; 5.50 F	195	835	385	2509	STD	8	TT	100 A6		30	800
	8 - 18	W 6	W 7; 5.50 F	195	835	385	2509	STD	4	TT	85 A6		30	515
	8 - 18	W 6	W 7; 5.50 F	195	835	385	2509	STD	6	TT	94 A6		30	670
	8 - 18	W 6	W 7; 5.50 F	195	835	391	2535	SPL	6	TT	94 A6		30	670
	8 - 18	W 6	W 7; 5.50 F	195	835	391	2535	SPL	8	TT	100 A6		30	800
Ø 20"	8.3 - 20	W 7	W 6	211	890	414	2670	STD	6	TT	96 A6		30	710
	8.3 - 20	W 7	W 6	211	890	414	2670	HD	6	TT	96 A6		30	710
Ø 22"	9.5 - 22	W 8	W 7	235	1000	464	3008	STD	6	TT	104 A6		30	900

STD: Standard - HD: Heavy Duty - SPL: Special

Performance



High Load Capacity



Traction



TRACTOR

Bias



TR 145 (R-1)

TR 145 has been specifically designed for small tractors. The special tread pattern provides excellent traction and outstanding self-cleaning properties. The wide and deep lug design ensures an extended tire service life. The TR 145 tire has a large contact area which offers excellent driving comfort and high directional stability.

Ø 12"	Tire size	RIM		S.W. (mm)	O.D. (mm)	SLR (mm)	RC (mm)	Version	PR	Type	LI/SS	Load capacity (kg/tire)	
		Rec.	Alt.									km/h - bar	2.50
	160/90 - 12	4.00	-	160	631	294	1969	STD	6	TT	76A6	30	400

STD: Standard

Performance



Durability



Self-Cleaning



Traction





TRACTOR



TR 171 (R-1 W+)



TR 171 is a deep tread tire suitable for tractors in soil tillage operations. Thanks to its outstanding self-cleaning properties, it is ideal for wet and moist soil. Designed with a special compound, TR 171 provides excellent traction and extraordinary durability also in the harshest operating conditions.

Ø 12"	Tire size	RIM		S.W. (mm)	O.D. (mm)	SLR (mm)	RC (mm)	Version	PR	Type	LI/SS	Load capacity (kg/tire)	
		Rec.	Alt.									km/h - bar	
Ø 12"	5.00 - 12	3.00 D DT; 3.00 D	4 JA; 3.50 B	130	580	272	1750	STD	4	TT	61 A6	30	257
	5.00 - 12	3.00 D DT; 3.00 D	4 JA; 3.50 B	130	580	272	1750	STD	6	TT	67 A6	30	307
	6.00 - 12	4.00 E DT; 4.00 E	4 JA	160	635	298	1953	STD	6	TT	76 A6	30	400
Ø 16"	9.5 - 16	W 8 L	8 LB	241	845	395	2607	STD	6	TT	96 A6	30	710
	8 - 18	W 6	W 7; 5.50 F	190	845	391	2617	STD	4	TT	85 A6	30	515
Ø 18"	8 - 18	W 6	W 7; 5.50 F	190	845	391	2617	STD	6	TT	94 A6	30	670
	8 - 18	W 6	W 7; 5.50 F	190	845	391	2617	STD	8	TT	100 A6	30	800
	9.5 - 18	W 8	-	241	900	423	2790	STD	8	TT	105 A6	30	925
	8.3 - 20	W 7	W 6	210	900	423	2704	STD	6	TT	96 A6	30	710
Ø 20"	8.3 - 20	W 7	W 6	210	900	422	2806	STD	8	TT	101 A6	30	825

Technologies



Performance



STD: Standard





TRACTOR

TR 171 (R-1 W+)

Ø 20"	Tire size	RIM		S.W. (mm)	O.D. (mm)	SLR (mm)	RC (mm)	Version	PR	Type	LI/SS	Load capacity (kg/tire)	
		Rec.	Alt.									km/h - bar	
												2.40	
	8.3 - 20	W 7	W 6	210	900	422	2788	HD	6	TT	96 A6	30	710
												3.20	
	8.3 - 20	W 7	W 6	210	900	424	2785	HD	8	TT	101 A6	30	825
												2.80	
	9.5 - 20	W 8	W 7	241	955	449	2942	STD	8	TT	107 A6	30	975
												2.10	
	9.5 - 20	W 8	W 7	241	955	449	2942	STD	6	TT	101 A6	30	825
												2.80	
	9.5 - 20	W 8	W 7	241	955	449	2942	HD	8	TT	107 A6	30	975
												2.60	
	11.2 - 20	W 10	W 9;9	285	1005	471	3101	STD	8	TT	113 A6	30	1150
												3.20	
	8.3 - 22	W 7	W 6	205	945	444	2778	STD	8	TT	104 A6	30	900
												3.00	
	9.5 - 22	W 8	W 7	244	1005	472	3107	STD	8	TT	110 A6	30	1060
												2.40	
	8.3 - 24	W 7	W 6	210	1005	474	3014	STD	6	TT	100 A6	30	800
												3.10	
	8.3 - 24	W 7	W 6	210	1005	474	3153	STD	8	TT	105 A6	30	925
												3.10	
	8.3 - 24	W 7	W 6	210	1005	474	3153	HD	8	TT	105 A6	30	925
												2.10	
	9.5 - 24	W 8	W 7	240	1066	500	3260	STD	6	TT	106 A6	30	950
												2.80	
	9.5 - 24	W 8	W 7	240	1066	496	3263	STD	8	TT	111 A6	30	1090

Technologies

Special Compound



Extra Deep Tread

Performance

Durability



High Load Capacity



Self-Cleaning



Traction

STD: Standard - HD: Heavy Duty



TRACTOR

TR 171 (R-1 W+)

Ø 24"	Tire size	RIM		S.W. (mm)	O.D. (mm)	SLR (mm)	RC (mm)	Version	PR	Type	LI/SS	Load capacity (kg/tire)	
		Rec.	Alt.									km/h - bar	1.80
11.2 - 24	W 10	W 9	285	1105	519	3388	STD	6	TT	110 A6		30	1060
11.2 - 24	W 10	W 9	285	1105	517	3403	STD	8	TT	116 A6		30	1250
11.2 - 24	W 10	W 9	285	1105	517	3403	STD	10	TT	120 A6		30	1400
12.4 - 24	W 11	W 9; W 10	315	1165	544	3557	STD	4	TT	106 A6		30	950
12.4 - 24	W 11	W 9; W 10	315	1165	544	3557	STD	6	TT	115 A6		30	1215
12.4 - 24	W 11	W 9; W 10	315	1165	544	3557	STD	8	TT	120 A6		30	1400
12.4 - 24	W 11	W 9; W 10	315	1165	544	3557	HD	8	TT	120 A6		30	1400
13.6 - 24	W 12	W 11	355	1210	562	3674	STD	6	TT	119 A6		30	1360
13.6 - 24	W 12	W 11	355	1210	562	3674	STD	8	TT	123 A6		30	1550
14.9 - 24	W 13	W 11; W 12	391	1265	575	3792	STD	6	TT	123 A6		30	1550
14.9 - 24	W 13	W 11; W 12	391	1265	575	3792	STD	8	TT	128 A6		30	1800

STD: Standard - HD: Heavy Duty

Technologies

Special Compound



Extra Deep Tread

Performance

Durability



High Load Capacity



Self-Cleaning



Traction





TRACTOR

TR 171 (R-1 W+)

Ø 26"	Tire size	RIM		S.W. (mm)	O.D. (mm)	SLR (mm)	RC (mm)	Version	PR	Type	LI/SS	Load capacity (kg/tire)	
		Rec.	Alt.									km/h - bar	
Ø 26"	11.2 - 26	W 10	W 9	284	1155	540	3396	STD	8	TT	117 A6	30	2.40 1285
	12.4 - 26	W 11	W 10; W 9	315	1210	573	3727	STD	8	TT	121 A6	30	2.30 1450
	13.6 - 26	W 12	W 11	340	1270	580	3774	STD	4	TT	110 A6	30	1.00 1060
	13.6 - 26	W 12	W 11	340	1270	582	3815	STD	6	TT	120 A6	30	1.60 1400
	13.6 - 26	W 12	W 11	340	1270	587	3835	STD	8	TT	126 A6	30	2.20 1700
	13.6 - 26	W 12	W 11	340	1270	589	3774	HD	12	TT	135 A6	30	3.40 2180
Ø 28"	12.4 - 28	W 11	W 9; W 10	315	1260	589	3860	STD	6	TT	117 A6	30	1.70 1285
	12.4 - 28	W 11	W 9; W 10	315	1260	589	3860	STD	8	TT	123 A6	30	2.30 1550
	12.4 - 28	W 11	W 9; W 10	315	1260	589	3860	STD	12	TT	131 A6	30	3.50 1950
	13.6 - 28	W 12	W 11	350	1325	614	4013	STD	4	TT	112 A6	30	1.00 1120
	13.6 - 28	W 12	W 11	350	1325	614	4013	STD	6	TT	121 A6	30	1.60 1450
	13.6 - 28	W 12	W 11	350	1325	614	4013	STD	8	TT	125 A6	30	2.00 1650

Technologies

Special Compound



Extra Deep Tread

Performance

Durability



High Load Capacity



Self-Cleaning



Traction

STD: Standard





TR 171 (R-1 W+)

Ø 28"	Tire size	RIM		S.W. (mm)	O.D. (mm)	SLR (mm)	RC (mm)	Version	PR	Type	LI/SS	Load capacity (kg/tire)	
		Rec.	Alt.									km/h - bar	
13.6 - 28	W 12	W 11	350	1325	614	4013	STD	12	TT	134 A6	km/h - bar	3.00	
											30	2120	
13.6 - 28	W 12	W 11	350	1325	614	4013	HD	8	TT	125 A6	km/h - bar	2.00	
											30	1650	
13.6 - 28	W 12	W 11	350	1325	614	4013	HD	12	TT	134 A6	km/h - bar	3.00	
											30	2120	
14.9 - 28	W 13	W 11; W 12	388	1370	636	4246	HD	8	TT	130 A6	km/h - bar	1.80	
											30	1900	
14.9 - 28	W 13	W 11; W 12	388	1370	636	4246	STD	12	TT	137 A6	km/h - bar	2.60	
											30	2300	
14.9 - 28	W 13	W 11; W 12	388	1370	636	4246	HD	12	TT	137 A6	km/h - bar	2.60	
											30	2300	
16.9 - 28	W 15 L	W 14 L	435	1440	674	4496	STD	8	TT	135 A6	km/h - bar	1.70	
											30	2180	
16.9 - 28	W 15 L	W 14 L	435	1440	674	4496	STD	12	TT	143 A6	km/h - bar	2.40	
											30	2725	
Ø 30"	14.9 - 30	W 13	W 11; W 12	380	1415	658	4282	STD	8	TT	131 A6	km/h - bar	1.80
												30	1950
16.9 - 30	W 15 L	W 14 L	430	1490	687	4535	STD	8	TT	137 A6	km/h - bar	1.70	
											30	2300	
16.9 - 30	W 15 L	W 14 L	430	1490	687	4605	STD	12	TT	143 A6	km/h - bar	2.40	
											30	2725	
18.4 - 30	W 16 L	W 15 L	470	1550	710	4706	STD	10	TT	145 A6	km/h - bar	1.80	
											30	2900	

STD: Standard - HD: Heavy Duty

Technologies



Special Compound



Extra Deep Tread

Performance



Durability



High Load Capacity



Self-Cleaning



Traction



TRACTOR

TR 171 (R-1 W+)

Ø 32"	Tire size	RIM		S.W. (mm)	O.D. (mm)	SLR (mm)	RC (mm)	Version	PR	Type	LI/SS	Load capacity (kg/tire)	
		Rec.	Alt.									km/h - bar	
												2.30	
	12.4 - 32	W 11	W 9; W 10	315	1370	643	4232	STD	8	TT	124 A6	30	1600
Ø 34"	16.9 - 34	W 15 L	W 14 L	429	1585	736	4838	STD	8	TT	139 A6	km/h - bar	1.70
												30	2430
Ø 36"	18.4 - 34	W 16 L	W 15 L	470	1655	768	4866	STD	10	TT	146 A6	km/h - bar	1.80
												30	3000
Ø 36"	12.4 - 36	W 11	W 9; W 10	315	1470	691	4332	STD	8	TT	126 A6	km/h - bar	2.30
												30	1700
Ø 38"	13.6 - 36	W 12	W 11	345	1520	717	4647	STD	8	TT	129 A6	km/h - bar	2.00
												30	1850
Ø 38"	13.6 - 38	W 12	W 11	345	1565	729	4818	STD	8	TT	131 A6	km/h - bar	2.00
												30	1950
Ø 38"	16.9 - 38	W 15 L	W 14 L	429	1685	788	4954	STD	8	TT	141 A6	km/h - bar	1.70
												30	2575
Ø 38"	18.4 - 38	W 16 L	W 15 L	470	1760	815	5364	STD	10	TT	148 A6	km/h - bar	1.80
												30	3150

STD: Standard

Technologies



Special Compound



Extra Deep Tread

Performance



Durability



High Load Capacity



Self-Cleaning



Traction





TRACTOR



Bias



TR 173 (R-1 W)

TR 173 is a tractor tire suitable for wet conditions and paddy fields. The special tread pattern provides outstanding self-cleaning properties in addition to reduced soil compaction thanks to a large contact area.

Ø 18"	Tire size	RIM		S.W. (mm)	O.D. (mm)	SLR (mm)	RC (mm)	Version	PR	Type	LI/SS	Load capacity (kg/tire)	
		Rec.	Alt.									km/h - bar	
													1.90
	8 - 18	W 6	W 7; 5.50 F	200	841	392	2525	STD	6	TT	94 A6	30	670
													2.40
Ø 20"	8.3 - 20	W 7	W 6	211	890	418	2713	STD	6	TT	96 A6	30	710
													2.40
Ø 22"	8.3 - 22	W 7	W 6	211	940	443	2869	STD	6	TT	98 A6	30	750
													2.20
	9.5 - 22	W 8	W 7	241	997	472	3045	STD	6	TT	104 A6	30	900
													2.40
Ø 24"	8.3 - 24	W 7	W 6	211	995	467	3009	STD	6	TT	100 A6	30	800
													2.10
	9.5 - 24	W 8	W 7	241	1047	493	3238	STD	6	TT	106 A6	30	950
													1.70
	12.4 - 24	W 11	W 9; W 10	315	1160	541	3509	STD	6	TT	115 A6	30	1215
													1.60
Ø 26"	13.6 - 26	W 12	W 11	345	1255	586	3786	STD	6	TT	120 A6	30	1400
													1.80
Ø 28"	14.9 - 28	W 13	W 11; W 12	385	1367	631	4215	STD	8	TT	130 A6	30	1900
													1.30
	16.9 - 28	W 15 L	W 14 L	445	1450	669	4454	STD	6	TT	129 A6	30	1850

Performance



STD: Standard



TRACTOR

Bias



FARM 2000 (R-1)

The FARM 2000 tire is suitable on tractors for soil tillage applications. It has been designed with a special cut-and-chip resistant compound to ensure better durability. Thanks to its strong casing, FARM 2000 offers high load capacity. It also provides great traction and self-cleaning properties.

Ø 15.3"	Tire size	RIM		S.W. (mm)	O.D. (mm)	SLR (mm)	RC (mm)	Version	PR	Type	LI/SS		Load capacity (kg/tire)	
		Rec.	Alt.								Drive Wheel	Free Rolling	km/h - bar	
260/70 - 15.3	9.00	-	265	775	349	2294	STD	-	TL	114A8	126A8	km/h - bar	3.60	
												10 FR	2380	
												25 FR	2025	
												30 FR	1905	
												40 FR	1700	
												10 DW	1650	
												25 DW	1405	
												30 DW	1320	
												40 DW	1180	
												300/80 - 15.3	9.00	-
10 FR	2800													
25 FR	2380													
30 FR	2240													
40 FR	2000													
10 DW	1960													
25 DW	1665													
30 DW	1570													
40 DW	1400													
Ø 16"	250/80 - 16	W 8	W 7 ; W 9 ; W 8 L	240	820	369	2429	STD	-	TT	113A8			
												10 FR	2310	
												25 FR	1965	
												30 FR	1850	
												40 FR	1650	
												10 DW	1610	
												25 DW	1370	
												30 DW	1290	
												40 DW	1150	
												250/80 - 16	W 8	W 7 ; W 9 ; W 8 L
10 FR	2310													
25 FR	1965													
30 FR	1850													
40 FR	1650													
10 DW	1610													
25 DW	1370													
30 DW	1290													
40 DW	1150													
Ø 18"	250/80 - 18	W 8	W 7 ; W 9	240	870	394	2679	STD	-	TT	115A8			
												10 FR	2450	
												25 FR	2085	
												30 FR	1960	
												40 FR	1750	
												10 DW	1700	
												25 DW	1445	
												30 DW	1360	
												40 DW	1215	

STD: Standard

Technologies



Performance





FARM 2000 (R-1)

Ø 18"	Tire size	RIM		S.W. (mm)	O.D. (mm)	SLR (mm)	RC (mm)	Version	PR	Type	LI/SS		Load capacity (kg/tire)		
		Rec.	Alt.								Drive Wheel	Free Rolling	km/h - bar		
250/80 - 18	W 8	W7; W9	240	870	394	2679	STD	-	TL	115 A8	127 A8	km/h - bar	2.80		
												10 FR	2450		
												25 FR	2085		
												30 FR	1960		
												40 FR	1750		
												10 DW	1700		
												25 DW	1445		
												30 DW	1360		
40 DW	1215														
8 - 18	W 6	-	195	840	390	2458	STD	4	TT	85 A6	km/h - bar	1.25			
											30	515			
8 - 18	W 6	-	195	840	393	2593	STD	6	TT	94 A6	km/h - bar	1.90			
											30	670			
Ø 20"	8.3 - 20	W 7	-	210	895	431	2714	STD	4	TT	-	-	km/h - bar	1.60	
													30	560	
8.3 - 20	W 7	-	210	895	431	2714	STD	6	TT	-	-	km/h - bar	2.40		
												30	710		
Ø 24"	8.3 - 24	W 7	W 6	211	995	473	3032	STD	6	TT	-	-	km/h - bar	2.40	
													30	810	
8.3 - 24	W 7	W 6	211	995	473	3032	STD	8	TT	105 A6	km/h - bar	3.10			
											30	925			
Ø 28"	12.4 - 28	W 11	W 9; W 10	320	1288	603	3969	STD	8	TT	123 A6	km/h - bar	2.30		
												30	1550		
	12.4 - 28	W 11	W 9; W 10	320	1288	603	3969	STD	10	TT	124 A6	km/h - bar	2.40		
												30	1600		
12.4 - 28	W 11	W 9; W 10	320	1288	603	3969	STD	12	TT	125 A6	km/h - bar	2.50			
											30	1650			
13.6 - 28	W 12	W 11	345	1335	622	4080	STD	8	TT	125 A6	km/h - bar	2.00			
											30	1650			

STD: Standard

Technologies



Reinforced Carcass



Special Compound



Strong Casing

Performance



Cut and Chip Resistance



Durability



High Load Capacity



Self-Cleaning



Traction



TRACTOR

FARM 2000 (R-1)

Ø 28"	Tire size	RIM		S.W. (mm)	O.D. (mm)	SLR (mm)	RC (mm)	Version	PR	Type	LI/SS	Load capacity (kg/tire)	
		Rec.	Alt.									km/h - bar	
	13.6 - 28	W 12	W 11	345	1335	622	4080	STD	10	TT	127A6	30	1750
	13.6 - 28	W 12	W 11	345	1335	622	4080	STD	12	TT	128A6	30	1800
	13.6 - 28	W 12	W 11	345	1335	622	4080	SPL	12	TT	128A6	30	1800
	14.9 - 28	W 13	W 11 ; W 12	385	1375	636	4194	STD	8	TT	130A6	30	1900
	14.9 - 28	W 13	W 11 ; W 12	385	1375	636	4194	STD	10	TT	132A6	30	2120
	14.9 - 28	W 13	W 11 ; W 12	385	1375	636	4194	STD	12	TT	134A6	30	2120
	14.9 - 28	W 13	W 11 ; W 12	385	1375	636	4194	STD	14	TT	136A6	30	2240
	16.9 - 28	W 15 L	W 14 L	429	1420	657	4351	STD	12	TT	143A6	30	2725
	16.9 - 28	W 15 L	W 14 L	429	1420	657	4351	HD	8	TT	135A6	30	2180
	18.4 - 30	W 16 L	-	470	1560	716	4776	STD	14	TT	151A6	30	3450

STD: Standard - SPL: Special - HD: Heavy Duty

Technologies



Reinforced Carcass



Special Compound



Strong Casing

Performance



Cut and Chip Resistance



Durability



High Load Capacity



Self-Cleaning



Traction



TRACTOR



FARM 2000 PLUS (R-1)



FARM 2000 PLUS is an agriculture tire featuring a higher number of lugs for better performance in the fields. The deep tread provides an extended tire life and great traction, whereas the superior tread compound ensures better cut and chip resistance. FARM 2000 PLUS shows excellent self-cleaning features and specially designed lug angles making the tire particularly suitable for field and haulage applications.

Ø 28"	Tire size	RIM		S.W. (mm)	O.D. (mm)	SLR (mm)	RC (mm)	Version	PR	Type	LI/SS	Load capacity (kg/tire)	
		Rec.	Alt.									km/h - bar	2.40
	16.9 - 28	W 15 L	W 14 L	440	1435	657	4311	STD	12	TT	143 A6	30	2725
	16.9 - 28	W 15 L	W 14 L	440	1435	657	4311	SPL	12	TT	143 A6	30	2725

STD: Standard - SPL: Special

Technologies



More Lugs



Deep Tread

Performance



Cut and Chip Resistance



Durability



High Load Capacity



Self-Cleaning



Traction





TRACTOR

Bias



FARM SPECIAL (R-1)

FARM SPECIAL is a tractor tire suitable for soil tillage operations. The strong casing provides a high level of puncture resistance and a longer service life, whilst the rounded shoulders prevent soil damages ensuring the protection of the valuable crops. FARM SPECIAL features a unique tread design with special mud breakers for best self-cleaning properties. In addition, dual angled lugs provide excellent traction and reduced slippage.

Ø 24"	Tire size	RIM		S.W. (mm)	O.D. (mm)	SLR (mm)	RC (mm)	Version	PR	Type	LI/SS	Load capacity (kg/tire)	
		Rec.	Alt.									km/h - bar	
Ø 24"	9.5 - 24	W 8	W 7	240	1050	491	3194	STD	8	TT	112 A6	30	1120
	11.2 - 24	W 10	W 9	285	1095	509	3283	STD	8	TT	116 A6	km/h - bar	2.40
												30	1250
	12.4 - 24	W 11	W 9; W 10	320	1155	534	3504	STD	8	TT	121 A6	km/h - bar	2.30
												30	1450
13.6 - 24	W 12	W 11	350	1205	554	3635	STD	8	TT	123 A6	km/h - bar	2.00	
											30	1550	
14.9 - 24	W 13	W 11; W 12	378	1255	572	3775	STD	8	TT	128 A6	km/h - bar	1.80	
											30	1800	
Ø 28"	11.2 - 28	W 10	W 9	285	1205	563	3694	STD	8	TT	118 A6	km/h - bar	2.40
												30	1320
	12.4 - 28	W 11	W 9; W 10	315	1265	589	3853	STD	8	TT	123 A6	km/h - bar	2.30
												30	1550
13.6 - 28	W 12	W 11	350	1310	610	3985	STD	8	TT	125 A6	km/h - bar	2.00	
											30	1650	
14.9 - 28	W 13	W 11; W 12	375	1355	620	4105	STD	8	TT	130 A6	km/h - bar	1.80	
											30	1900	
Ø 30"	16.9 - 30	W 15 L	W 14 L	431	1469	671	4456	STD	8	TT	137 A6	km/h - bar	1.70
												30	2300

Technologies



Performance



STD: Standard





TRACTOR

FARM SPECIAL (R-1)

Ø 30"	Tire size	RIM		S.W. (mm)	O.D. (mm)	SLR (mm)	RC (mm)	Version	PR	Type	LI/SS	Load capacity (kg/tire)	
		Rec.	Alt.									km/h - bar	
	18.4 - 30	W 16 L	W 15 L	451	1533	689	4599	STD	8	TT	139 A6	30	2430
													1.40
													2.30
													1600
													2.00
													1850
													2.00
													1950
													2.00
													1950
													1.80
													2060

STD: Standard

Technologies



Reinforced Carcass



Strong Casing

Performance



Cut and Chip Resistance



Durability



High Load Capacity



High Puncture Resistance



Self-Cleaning



Traction





TRACTOR

Bias



AS 2001 (R-1)

AS 2001 is a bias cross-ply tire which best suits tractors in soil tillage operations. Its design provides excellent traction and self-cleaning properties. AS 2001 is made of a special cut-and-chip resistant compound that also ensures great load capacity.

Ø 26"	Tire size	RIM		S.W. (mm)	O.D. (mm)	SLR (mm)	RC (mm)	Version	PR	Type	LI/SS	Load capacity (kg/tire)		
		Rec.	Alt.									km/h - bar		
Ø 26"	18.4 - 26	W 16 L	W 15 L	467	1475	650	4250	STD	10	TT	142 A6	30	1.80	2650
	18.4 - 26	W 16 L	W 15 L	467	1475	650	4250	STD	10	TL	142 A6	30	1.80	2650
	18.4 - 26	W 16 L	W 15 L	467	1475	650	4250	STD	12	TT	146 A6	30	2.30	3000
	18.4 - 26	W 16 L	W 15 L	467	1475	650	4250	STD	12	TL	146 A6	30	2.30	3000
	18.4 - 26	W 16 L	W 15 L	467	1475	650	4250	STD	14	TT	149 A6	30	2.60	3250
Ø 28"	16.9 - 28	W 15 L	W 14 L	429	1420	651	4319	STD	8	TT	135 A6	30	1.70	2180
	16.9 - 28	W 15 L	W 14 L	429	1420	651	4319	STD	10	TT	139 A6	30	2.00	2430
	16.9 - 28	W 15 L	W 14 L	429	1420	651	4319	STD	12	TT	143 A6	30	2.40	2725
	16.9 - 28	W 15 L	W 14 L	429	1420	651	4319	STD	12	TL	143 A6	30	2.40	2725
	16.9 - 28	W 15 L	W 14 L	429	1420	651	4319	SPL	12	TT	143 A6	30	2.40	2725

Technologies



Performance



STD: Standard - SPL: Special



TRACTOR

Bias



TRAC FARM (R-1)

TRAC FARM is a heavy-duty tire specifically designed for tractors in soil tillage and haulage applications. Its deep tread and the special cut-and-chip-resistant compound make the tire suitable for the most difficult operating conditions, ensuring the best return on investment during the entire product life-cycle. TRAC FARM has been designed with more lugs providing extraordinary traction and self-cleaning properties.

Ø 20"	Tire size	RIM		S.W. (mm)	O.D. (mm)	SLR (mm)	RC (mm)	Version	PR	Type	LI/SS	Load capacity (kg/tire)	
		Rec.	Alt.									km/h - bar	
	11.2 - 20	W 10	W 9	290	1000	463	2940	STD	8	TT	111 A6	30	1090
												km/h - bar	2.40
												30	2.40
												30	1600
												km/h - bar	2.50
												30	1650
												km/h - bar	2.30
												30	1800
												km/h - bar	2.40
												30	2725
												km/h - bar	2.30
												30	3250
												km/h - bar	2.60
												30	3450
												km/h - bar	2.60
												30	3450

STD: Standard - HD: Heavy Duty

Technologies



More Lugs

Performance



Cut and Chip Resistance



Durability



High Load Capacity



Self-Cleaning



Traction



TRACTOR

Bias



TRAC FARM PLUS (R-1)

TRAC FARM PLUS is a rear tractor tire specifically designed for soil tillage and haulage applications. The tire features a deeper tread with dual angle lugs to ensure both excellent traction and a comfortable ride on the road. The special tread design provides more contact for better stability and great self-cleaning properties. TRAC FARM PLUS ensures a longer tire life-cycle.

Ø 28"	Tire size	RIM		S.W. (mm)	O.D. (mm)	SLR (mm)	RC (mm)	Version	PR	Type	LI/SS	Load capacity (kg/tire)	
		Rec.	Alt.									km/h - bar	
	12.4 - 28	W 11	W 9; W 10	320	1295	603	3899	STD	12	TT	125 A6	30	1650
	13.6 - 28	W 12	W 11	365	1345	621	4088	STD	12	TT	128 A6	30	1800
	14.9 - 28	W 13	W 12; W 11	390	1380	642	4179	STD	12	TT	134 A6	30	2120
	16.9 - 28	W 15 L	W 14 L	440	1435	660	4298	STD	12	TT	143 A6	30	2725
	16.9 - 30	W 15 L	W 14 L	440	1475	679	4466	STD	12	TT	144 A6	30	2800

STD: Standard

Technologies



Larger Footprint

Performance



Durability



Handling and Comfort



High Load Capacity



Self-Cleaning



Traction





TRACTOR

Bias



COMMANDER (R) (R-1)

COMMANDER (R) is an agricultural tire featuring a deep tread with strong lug bases for a longer tire life-cycle. The special dual-angle lug design provides excellent traction in the fields and top self-cleaning properties. The strong casing is made of a cut-and-chip-resistant compound providing better puncture resistance together with high load capacity. COMMANDER (R) is the perfect tire for soil tillage, haulage and harvesting operations.

Ø 20"	Tire size	RIM		S.W. (mm)	O.D. (mm)	SLR (mm)	RC (mm)	Version	PR	Type	LI/SS	Load capacity (kg/tire)	
		Rec.	Alt.									km/h - bar	3.0
	9.5 - 20	W 8	W 7	245	970	456	2949	STD	12	TT	109 A6	30	1030
	9.5 - 24	W8	W 7	245	1065	507	3308	STD	12	TT	114 A6	30	1150
	11.2 - 24	W 10	W 9	295	1125	533	3483	STD	12	TT	123 A6	30	1550
	12.4 - 24	W 11	W 10	328	1180	569	3669	STD	8	TT	121 A6	30	1450
	12.4 - 24	W 11	W 10	328	1180	569	3669	STD	12	TT	128 A6	30	1800
	12.4 - 28	W 11	W 9; W 10	320	1285	600	3946	STD	12	TT	125 A6	30	1650
	13.6 - 28	W 12	W 11	360	1345	623	4068	STD	12	TT	128 A6	30	1800
	14.9 - 28	W 13	W 11; W 12	388	1380	642	4176	STD	12	TT	134 A6	30	2120
	15.9 - 28	W 13	W 11; W 12	405	1410	-	-	STD	12	TT	140 A6	30	2500
	16.9 - 28	W 15 L	W 14 L	435	1435	663	4274	STD	12	TT	143 A6	30	2725
	16.9 - 28 (21L)	W 15 L	W 14 L	440	1435	-	-	STD	12	TT	143 A6	30	2725

Technologies



Extra Deep Tread

Performance



Cut and Chip Resistance



Durability



High Load Capacity



Self-Cleaning



Traction

STD: Standard





TRACTOR

COMMANDER (R) (R-1)

Ø 28"	Tire size	RIM		S.W. (mm)	O.D. (mm)	SLR (mm)	RC (mm)	Version	PR	Type	LI/SS	Load capacity (kg/tire)	
		Rec.	Alt.									km/h - bar	2.20
	17.9 - 28	W 15 L	W 14 L	458	1515	-	-	STD	12	TT	144 A6	30	2800
Ø 30"	16.9 - 30	W 15 L	W 14 L	440	1480	689	4537	STD	12	TT	144 A6	km/h - bar	2.4
												30	2800
	18.4 - 30	W 16 L	-	472	1565	734	4834	STD	8	TT	139 A6	km/h - bar	1.4
												30	2430
	18.4 - 30	W 16 L	-	472	1565	734	4834	STD	14	TT	151 A6	km/h - bar	2.6
												30	3450
18.4 - 30	W 16 L	-	472	1565	734	4834	STD	18	TT	155 A6	km/h - bar	3.2	
											30	3875	
18.4 - 30	W 16 L	-	472	1565	734	4834	STD	18	TL	155 A6	km/h - bar	3.2	
											30	3875	
Ø 36"	9.5 - 36	W 8	W 7	246	1376	-	-	STD	12	TT	126 A6	km/h - bar	4.20
												30	1700

Technologies



Extra Deep Tread

Performance



Cut and Chip Resistance



Durability



High Load Capacity



Self-Cleaning



Traction

STD: Standard





TRACTOR

Bias



TR 270 (R-2)

TR 270 is a tractor tire suitable for soil tillage applications. It is specially designed for providing maximum performance on wet and moist soil. In these soil conditions, a tire is required to offer superior grip and enhanced self-cleaning features. TR 270 perfectly meets all these characteristics.

Ø 26"	Tire size	RIM		S.W. (mm)	O.D. (mm)	SLR (mm)	RC (mm)	Version	PR	Type	LI/SS	Load capacity (kg/tire)	
		Rec.	Alt.									km/h - bar	
Ø 26"	23.1 - 26	DW 20 A ; DW 20 B	-	590	1646	739	4922	STD	8	TT	145 A6	30	2900
	23.1 - 26	DW 20 A ; DW 20 B	-	590	1646	739	4922	STD	10	TT	149 A6	30	3250
	23.1 - 26	DW 20 A ; DW 20 B	-	590	1646	739	4922	STD	12	TT	153 A6	30	3650
	23.1 - 26	DW 20 A ; DW 20 B	-	590	1646	739	4922	STD	12	TL	153 A6	30	3650
	23.1 - 26	DW 20 A ; DW 20 B	-	590	1646	739	4922	STD	14	TT	156 A6	30	4000
Ø 30"	18.4 - 30	DW 16 L ; DW 16 A	W 15 L ; DW 15 A	465	1580	720	4787	STD	8	TT	139 A6	30	2430
	18.4 - 30	DW 16 L ; DW 16 A	W 15 L ; DW 15 A	465	1580	720	4787	STD	8	TL	139 A6	30	2430
	18.4 - 30	DW 16 L ; DW 16 A	W 15 L ; DW 15 A	465	1580	720	4787	STD	12	TT	149 A6	30	3250
	23.1 - 30	DW 20 A ; DW 20 B	-	590	1748	790	5227	STD	8	TT	146 A6	30	3000
	23.1 - 30	DW 20 A ; DW 20 B	-	590	1748	790	5227	STD	10	TT	151 A6	30	3450

Technologies



Extra Deep Tread

Performance



Cut and Chip Resistance



Durability



For muddy ground



Self-Cleaning



Traction

STD: Standard





TRACTOR

TR 270 (R-2)

Ø 30"	Tire size	RIM		S.W. (mm)	O.D. (mm)	SLR (mm)	RC (mm)	Version	PR	Type	LI/SS	Load capacity (kg/tire)		
		Rec.	Alt.									km/h - bar	1.70	
23.1 - 30	DW 20 A ; DW 20 B	-	-	590	1748	790	5227	STD	12	TT	155 A6	30	3875	
Ø 34"													km/h - bar	1.40
18.4 - 34	DW 16 A ; W 16 L	W 15 L	-	465	1682	771	5029	STD	8	TT	142 A6	30	2650	
18.4 - 34	DW 16 A ; W 16 L	W 15 L	-	465	1682	771	5029	STD	12	TT	150 A6	30	3350	
23.1 - 34	DW 20 A ; DW 20 B	-	-	590	1850	841	5532	STD	8	TT	148 A6	30	3150	
23.1 - 34	DW 20 A ; DW 20 B	-	-	590	1850	841	5532	STD	10	TT	153 A6	30	3650	
23.1 - 34	DW 20 A ; DW 20 B	-	-	590	1850	841	5532	STD	12	TT	156 A6	30	4000	
23.1 - 34	DW 20 A ; DW 20 B	-	-	590	1850	841	5532	STD	14	TT	160 A6	30	4500	
Ø 38"													km/h - bar	1.50
13.6 - 38	W12	DW12A ; W11	-	345	1600	-	-	STD	6	TT	122 A6	30	1500	
18.4 - 38	W 16 A ; W 16 L	W 15 L ; DD 16	-	465	1784	822	5334	STD	8	TT	143 A6	30	2725	
18.4 - 38	W 16 A ; W 16 L	W 15 L ; DD 16	-	465	1784	822	5334	STD	12	TT	153 A6	30	3650	
20.8 - 38	W 18 A ; W 18 L	DD 18 ; DW 18 A	-	530	1875	861	5695	STD	8	TT	148 A6	30	3150	
20.8 - 38	W 18 A ; W 18 L	DD 18 ; DW 18 A	-	530	1875	861	5695	STD	10	TT	151 A6	30	3450	

STD: Standard

Technologies



Extra Deep Tread

Performance



Cut and Chip Resistance



Durability



For muddy ground



Self-Cleaning



Traction





TRACTOR

TR 270 (R-2)

Ø 38"	Tire size	RIM		S.W. (mm)	O.D. (mm)	SLR (mm)	RC (mm)	Version	PR	Type	LI/SS	Load capacity (kg/tire)	
		Rec.	Alt.									km/h - bar	
												2.00	
	20.8 - 38	W 18 A ; W 18 L	DD 18 ; DW 18 A	530	1875	861	5695	STD	12	TT	156 A6	30	4000

Ø 46"	Tire size	W12	W12A	345	1804	-	-	STD	6	TT	125 A6	Load capacity (kg/tire)	
												km/h - bar	
												1.50	
	13.6 - 46											30	1650

STD: Standard

Technologies



Extra Deep Tread

Performance



Cut and Chip Resistance



Durability



For muddy ground



Self-Cleaning



Traction





TRACTOR

Bias



TR 273 (R-2)

TR 273 is a tractor tire suitable for soil tillage and specifically designed to provide maximum performance on wet and moist soil. In these soil conditions, a tire is required to offer superior grip and enhanced self-cleaning properties. TR 273 perfectly meets all these characteristics.

Ø 24"	Tire size	RIM		S.W. (mm)	O.D. (mm)	SLR (mm)	RC (mm)	Version	PR	Type	LI/SS	Load capacity (kg/tire)	
		Rec.	Alt.									km/h - bar	
												2.30	
	12.4 - 24	W 11	W 10	315	1195	550	3722	STD	8	TT	121 A6	30	1450
	13.6 - 24	W 12	W 11	350	1240	570	3795	STD	8	TT	123 A6	30	1550
	14.9 - 24	W 13	W 12	380	1310	595	4044	STD	8	TT	128 A6	30	1800
	14.9 - 24	W 13	W 12	380	1310	595	4044	STD	10	TT	132 A6	30	2000
Ø 26"	18.4 - 26	W 16	W 15	470	1490	673	4534	STD	12	TT	146 A6	30	3000
	23.1 - 26	DW 20 A ; DW 20 B	-	590	1655	737	5053	STD	14	TT	156 A6	30	4000
	23.1 - 26	DW 20 A ; DW 20 B	-	590	1655	737	5053	STD	10	TT	149 A6	30	3250
	23.1 - 26	DW 20 A ; DW 20 B	-	590	1655	737	5053	STD	12	TT	153 A6	30	3650
Ø 28"	14.9 - 28	W 13	W 12	385	1410	651	4368	STD	8	TT	130 A6	30	1900
Ø 30"	16.9 - 30	W 15 L	W 14 L	435	1530	706	4800	STD	12	TT	143 A6	2.40	
												30	2725

Technologies



Extra Deep Tread

Performance



Cut and Chip Resistance



Durability



For muddy ground



Self-Cleaning



Traction

STD: Standard



Ø 30"	Tire size	RIM		S.W. (mm)	O.D. (mm)	SLR (mm)	RC (mm)	Version	PR	Type	LI/SS	Load capacity (kg/tire)	
		Rec.	Alt.									km/h - bar	
													2.30
	18.4 - 30	W 16 L	W 15 L	465	1585	723	4924	STD	12	TT	149 A6	30	3250
	23.1 - 30	DW 20 A ; DW 20 B	-	590	1748	794	5356	STD	10	TT	151 A6	30	3450
	23.1 - 30	DW 20 A ; DW 20 B	-	590	1748	794	5356	STD	14	TT	157 A6	30	4125
													2.20
	18.4 - 34	DW 16A	W16L ; W15L ; DW15L	475	1701	775	5253	STD	12	TT	150 A6	30	3350
	23.1 - 34	DW 20 A ; DW 20 B	-	590	1850	833	5634	STD	10	TT	153 A6	30	3650
	23.1 - 34	DW 20 A ; DW 20 B	-	590	1850	833	5634	STD	14	TT	160 A6	30	4500
													2.30
	18.4 - 38	W 16	W 15	465	1800	822	5579	STD	12	TT	152 A6	30	3550

STD: Standard

Technologies

Extra Deep Tread

Performance

 Cut and Chip
Resistance

Durability



For muddy ground



Self-Cleaning



Traction





PUDDLE SPECIAL (A) (R-2+)

PUDDLE SPECIAL is a R-2 agricultural tire specifically designed for operations in paddy fields. The extra deep tread design along with the special lug pattern provides best grip and excellent traction even on wet and soft soil. The wide center bar provides better adaptability for road applications and provides extraordinary service performance. In addition, PUDDLE SPECIAL shows superior self-cleaning features and excellent durability.

Ø 28"	Tire size	RIM		S.W. (mm)	O.D. (mm)	SLR (mm)	RC (mm)	Version	PR	Type	LI/SS	Load capacity (kg/tire)	
		Rec.	Alt.									km/h - bar	
	12.4 - 28	W 11	W 10	325	1385	649	4067	STD	12	TT	137A2	10	2300
												10	3.50
												10	1.60
												10	1090
												10	1080

STD: Standard

Technologies



Extra Deep Tread



More Lugs

Performance



Durability



Self-Cleaning



Traction



PUDDLE SPECIAL (B)

PUDDLE SPECIAL is a R-2 agricultural tire specifically designed for operations in paddy fields. The extra deep tread design along with the special lug pattern provides best grip and excellent traction even on wet and soft soil. The wide center bar provides better adaptability for road applications and provides extraordinary service performance. In addition, PUDDLE SPECIAL shows superior self-cleaning features and excellent durability.

Ø 26"	Tire size	RIM		S.W. (mm)	O.D. (mm)	SLR (mm)	RC (mm)	Version	PR	Type	LI/SS	Load capacity (kg/tire)	
		Rec.	Alt.									km/h - bar	
	120/90 - 26	4 JA	-	127	940	448	2847	STD	6	TT	90A2	10	600
												10	3.00
												10	3.00
												10	600

STD: Standard

Technologies



Extra Deep Tread

Performance



Durability



Self-Cleaning



Traction



TRACTOR



Bias



TR 318

TR 318 is specifically designed for sprayers and implement machinery. Its dual-angled lugs provide excellent traction and outstanding driving comfort. TR 318 also features extraordinary self-cleaning properties.

Ø 12"	Tire size	RIM		S.W. (mm)	O.D. (mm)	SLR (mm)	RC (mm)	Version	PR	Type	LI/SS	Load capacity (kg/tire)	
		Rec.	Alt.									km/h - bar	3.0
	23 X 9.00 - 12	7.0	-	220	585	-	-	STD	6	TT	93A3	15	650
	23 X 9.00 - 12	7.0	-	220	585	-	-	STD	6	TL	93A3	15	650
	26 X 10.00 - 12	8.5	-	265	675	-	-	STD	8	TT	107A3	15	975

Performance



STD: Standard



TRACTOR

Bias



AT 316

AT 316 is suitable for compact utility tractors in municipality and maintenance applications. The special tread design provides excellent traction without compromising field protection - an essential feature for this kind of application. AT 316 is also available as "aramid-belted" version to provide increased puncture resistance.

Ø 12"	Tire size	RIM		S.W. (mm)	O.D. (mm)	SLR (mm)	RC (mm)	Version	PR	Type	LI/SS	Load capacity (kg/tire)	
		Rec.	Alt.									km/h - bar	
												1.40	
	24 X 12.00 - 12	10,50 I - 55 ; I - 70 ; I - 90	-	315	610	271	1769	STD	4	TL	-	15	775
												2.20	
	24 X 12.00 - 12	10,50 I - 55 ; I - 70 ; I - 90	-	315	610	271	1769	AB	6	TL	-	15	1030

Performance



STD: Standard - AB: Aramid Belted





HARVESTER





HARVESTER

Radial



AGRIMAX TERIS

Today's high-power harvesters require tires that are able to support heavy equipment and loads without damaging the crops. BKT is committed to provide you with radial tires at the cutting edge to increase your yield. AGRIMAX TERIS is the right partner for all your combined operations. Excellent traction properties and high load capacity are its essential features providing best performance in all harvesting operations. The special sidewall protection and a reinforced shoulder increase resistance - thus extending the product life-cycle - also in harsh conditions and if there are stubbles in the fields.

AGRIMAX TERIS
RADIAL HARVESTING TIRES

Ø 26"	Tire size	LI/SS	RIM		S.W. (mm)	O.D. (mm)	SLR (mm)	RC (mm)	SRI (index)	Version	Load capacity (kg/tire)										
			Rec.	Alt.							km/h - bar	0.8	1.0	1.4	1.6	2.0	2.4	2.8	3.2		
620/75 R 26 CHO	166 A8/B	DW 20 B	-	625	1590	730	4851	750	STD	50	2440	2810	3445	3765	4135	4505	4880	5300			
										40	2440	2810	3445	3765	4135	4505	4880	5300			
										30	2615	3010	3690	4030	4430	4825	5225	5675			
										15 Cyc	4025	4635	5685	6210	6825	7435	8050	8745			
										10 Cyc	4390	5060	6205	6775	7445	8110	8780	9540			
750/65 R 26 CHO (28L R 26)	171 A8/B	DW 25 B	DW 23 B	764	1636	713	4908	750	STD	50	2915	3340	4085	4400	4930	5300	5720	6150			
										40	2915	3340	4085	4400	4930	5300	5720	6150			
										30	3125	3580	4370	4715	5280	5675	6125	6585			
										15 Cyc	4810	5510	6735	7260	8135	8745	9440	10150			
										10 Cyc	5250	6015	7350	7920	8875	9540	10300	11070			
750/65 R 26 CHO (28L R 26)	166 A8/B	DW 25 B	DW 23 B	764	1636	713	4908	750	STD	50	2915	3340	4085	4400	4930	5300	5720	6150			
										40	2915	3340	4085	4400	4930	5300	5720	6150			
										30	3125	3580	4370	4715	5280	5675	6125	6585			
										15 Cyc	4810	5510	6735	7260	8135	8745	9440	10150			
										10 Cyc	5250	6015	7350	7920	8875	9540	10300	11070			
Ø 28"	710/55 R 28 CHO	164 A8/B	DW 23 B	-	716	1493	663	4442	700	STD	50	1950	2250	2550	2900	3200	3550	3950	4250	4650	5000
											40	1950	2250	2550	2900	3200	3550	3950	4250	4650	5000
											30	2090	2410	2730	3105	3425	3800	4230	4550	4980	5350
											15 Cyc	3220	3715	4210	4785	5280	5860	6520	7015	7675	8250
											10 Cyc	3510	4050	4590	5220	5760	6390	7110	7650	8370	9000
Ø 30"	620/75 R 30 CHO	168 A8/B	DW 20 B	-	625	1692	779	5169	800	STD	50	2580	2970	3640	3980	4370	4760	5155	5600		
											40	2580	2970	3640	3980	4370	4760	5155	5600		
											30	2760	3180	3900	4260	4680	5100	5520	5995		
											15 Cyc	4255	4900	6010	6565	7210	7855	8505	9240		
											10 Cyc	4640	5345	6555	7160	7865	8570	9275	10080		
Ø 32"	1050/50 R 32 CHO	184 A8/181 B	36.0 VA	-	1059	1893	840	5685	875	STD	50	3715	4210	5280	5860	6520	7015	7675	8250		
											40	4050	4590	5760	6390	7110	7650	8370	9000		
											30	4335	4915	6165	6840	7610	8190	8960	9630		
											15 Cyc	6685	7575	9505	10545	11735	12625	13815	14850		
											10 Cyc	7290	8265	10370	11505	12800	13770	15070	16200		

STD: Standard

* For 15 & 10 Cyc application inflation pressure to be increased by 0.8 bar

Technologies



Reinforced Bead



Reinforced Shoulder



Special Compound



IF Technology

Performance



High Load Capacity



High Puncture Resistance



Stability



Traction



AGRIMAXTERIS

Ø 32"	Tire size	LI/SS	RIM		S.W. (mm)	O.D. (mm)	SLR (mm)	RC (mm)	SRI (index)	Version	Load capacity (kg/tire)											
			Rec.	Alt.							km/h - bar	0.8	1.0	1.4	1.6	2.0	2.4	2.8	3.2			
650/75 R 32 CHO	172 A8/B	DW 21 B	DW 20 B ; DW 23 B	670	1795	816	5378	850	STD	50	2900	3340	4095	4475	4915	5355	5800	6300				
										40	2900	3340	4095	4475	4915	5355	5800	6300				
										30	3105	3575	4385	4790	5265	5735	6210	6745				
										15 Cyc	4785	5510	6760	7385	8110	8840	9565	10395				
										10 Cyc	5220	6015	7375	8055	8850	9640	10435	11340				
800/65 R 32 CHO (30.5L R 32)	178 A8/ 175 B	DW 27 B	DW 25 B ; DH 27 B	818	1853	838	5551	875	STD	50	3175	3660	4485	4900	5455	5865	6420	6900				
										40	3450	3975	4875	5325	5925	6375	6975	7500				
										30	3695	4255	5220	5700	6340	6825	7465	8025				
										15 Cyc	5695	6560	8045	8790	9780	10520	11510	12375				
										10 Cyc	6210	7155	8775	9585	10665	11475	12555	13500				
900/60 R 32 CHO	181 A8/ 178 B	DW 27 B	DW 28 B ; DW 30 B	886	1910	875	5775	900	STD	50	3375	3825	4800	5325	5925	6375	6975	7500				
										40	3715	4210	5280	5860	6520	7015	7675	8250				
										30	3975	4505	5655	6270	6980	7510	8215	8830				
										15 Cyc	6130	6945	8715	9670	10760	11575	12665	13615				
										10 Cyc	6685	7575	9505	10545	11735	12625	13815	14850				
900/60 R 32 CHO	185 A8/ 182 B	DW 27 B	DW 28 B ; DW 30 B	875	1910	875	5775	900	STD	50	3375	3825	4800	5325	5925	6375	6975	7500	7990	8500		
										40	3715	4210	5280	5860	6520	7015	7675	8250	8695	9250		
										30	3975	4505	5655	6270	6980	7510	8215	8830	9305	9900		
										15 Cyc	6130	6945	8715	9670	10760	11575	12665	13615	14350	15265		
										10 Cyc	6685	7575	9505	10545	11735	12625	13815	14850	15655	16650		
IF 710/75 R 32 CFO	183 A8/B	DW 25 B	DW 23 B	716	1879	851	5653	875	STD	50	3415	4025	4640	5775	6300	6915	7440	8140	8750			
										40	3415	4025	4640	5775	6300	6915	7440	8140	8750			
										30	3655	4310	4965	6185	6745	7400	7965	8710	9365			
										15 Cyc*	5295	6240	7190	8955	9770	10720	11535	12620	13565			
										10 Cyc*	6145	7245	8350	10395	11340	12445	13390	14650	15750			
Ø 34"	IF 580/80 R 34 CFO	177 D	DW 20 B ; DW 20 A	DW 21 A ; DW 21 B	586	1792	810	5422	850	STD	70	2460	2860	3260	3725	4120	4520	4985	5250	5785	6250	6645
											From 65 to 40	2705	3140	3580	4090	4530	4965	5405	5770	6355	6865	7300
											30	2815	3270	3725	4225	4710	5165	5700	6005	6610	7140	7595
											20	2920	3395	3865	4420	4890	5365	5915	6230	6860	7415	7885
											10	3435	3990	4545	5195	5755	6310	6960	7330	8070	8720	9275
											Upto 30 Cyc*	3515	4085	4655	5315	5885	6455	7210	7500	8260	8925	9490
											Upto 15 Cyc*	4190	4870	5545	6340	7020	7695	8490	8940	9845	10640	11315
											10 HT	2815	3270	3725	4225	4710	5165	5700	6005	6610	7140	7595

STD: Standard

* For 15 & 10 & 30 Cyc application inflation pressure to be increased by 0.8 bar

Technologies



Reinforced Bead



Reinforced Shoulder



Special Compound



IF Technology

Performance



High Load Capacity



High Puncture Resistance



Stability



Traction



HARVESTER

AGRIMAXTERIS

Ø 34"	Tire size	LI/SS	RIM		S.W. (mm)	O.D. (mm)	SLR (mm)	RC (mm)	SRI (index)	Version	Load capacity (kg/tire)										
			Rec.	Alt.							km/h - bar	0.6	0.8	1.0	1.2	1.4	1.6	2.0	2.4	2.8	3.2
IF 710/75 R 34 CFO	184 A8/B	DW 25 B	-	716	1930	870	5852	900	STD	50	3510	4050	4590	5220	5760	6390	7110	7650	8370	9000	
										40	3510	4050	4590	5220	5760	6390	7110	7650	8370	9000	
										30	3760	4335	4915	5590	6165	6840	7610	8190	8960	9630	
										15 Cyc*	5795	6685	7575	8615	9505	10545	11735	12625	13815	14850	
										10 Cyc*	6320	7290	8265	9400	10370	11505	12800	13770	15070	16200	

Ø 42"	Tire size	LI/SS	RIM	S.W. (mm)	O.D. (mm)	SLR (mm)	RC (mm)	SRI (index)	Version	Load capacity (kg/tire)											
										km/h - bar	0.6	0.8	1.0	1.2	1.4	1.6	2.0	2.4	2.8	3.2	3.8
520/85 R 42	168 D	DW 16 L	-	516	1951	890	5851	925	STD	65	1850	2185	2520	2800	3140	3420	3980	4540	5100	5600	-
										50	1945	2295	2650	2940	3295	3590	4175	4765	5355	5880	-
										40	2025	2395	2765	3070	3440	3745	4360	4970	5585	6135	-
										30	2130	2515	2900	3220	3610	3930	4575	5250	5865	6440	-
										25	2195	2590	2990	3320	3720	4055	4715	5380	6045	6640	-
										10	2775	3280	3780	4200	4705	5125	5965	6805	7645	8400	-
10 Cyc*	-	-	-	-	-	-	-	-	-	-	-	-	-	-	-	-	9520				

STD: Standard

* For 15 & 10 Cyc application inflation pressure to be increased by 0.8 bar

Technologies



Reinforced Bead



Reinforced Shoulder



Special Compound



IF Technology

Performance



High Load Capacity



High Puncture Resistance



Stability



Traction





HARVESTER

Radial



AGRIMAX RT 600

AGRIMAX RT 600 is the ideal tire for grassland, harvesting and spreading applications. Thanks to its large contact area, AGRIMAX RT 600 ensures an excellent pressure distribution on the land reducing damage on grassland and protecting your soil. Thanks to its round shoulder technology, the reinforced bead and increased number of lugs, it guarantees great stability and traction.

AGRIMAX
RADIAL TRACTOR TIRES

Ø 26"	Tire size	LI/SS	RIM		S.W. (mm)	O.D. (mm)	SLR (mm)	RC (mm)	SRI (index)	Version	Load capacity (kg/tire)											
			Rec.	Alt.							km/h - bar	0.8	1.0	1.2	1.4	1.6	2.0	2.4	2.8	3.2	3.4	3.8
750/65 R 26	171 A8/B	DW 24 B	DW 23 B ; DW 25 B	750	1636	737	4987	775	STD	km/h - bar	0.8	1.0	1.2	1.4	1.6	2.0	2.4	2.8	3.2	3.4	3.8	
										50	2830	3260	3690	4000	4370	4860	5230	5720	6150	-	-	
										40	2830	3260	3690	4000	4370	4860	5230	5720	6150	-	-	
										30	3030	3495	3955	4285	4680	5205	5600	6125	6585	-	-	
										10 LT	3795	4370	4950	5360	5855	6515	7010	7670	8245	-	-	
										10 HT	3030	3495	3955	4285	4680	5205	5600	6125	6585	-	-	
10 Cyc	-	5240	5930	6425	7015	7810	8400	9190	9880	10010	10455											
750/70 R 26	172 A8/B	DW 25 B	DW 24 B	780	1750	785	5269	825	STD	km/h - bar	0.6	0.8	1.0	1.2	1.4	1.6	2.0	2.4	2.8	3.2	3.6	
										50	2710	3150	3595	4035	4475	4915	5420	5735	6300	-	-	
										40	2710	3150	3595	4035	4475	4915	5420	5735	6300	-	-	
										30	2905	3375	3850	4320	4795	5265	5805	6145	6750	-	-	
										10 LT	3635	4225	4820	5410	6000	6595	7270	7690	8450	-	-	
										10 HT	2905	3375	3850	4320	4795	5265	5805	6145	6750	-	-	
10 Cyc	-	5065	5775	6480	7190	7900	8710	9215	10125	10285	10710											
620/75 R 26 (23.1 R 26)	167 A8/B	DW 20 B	-	625	1590	730	4851	750	STD	km/h - bar	0.8	1.0	1.4	1.6	2.0	2.4	2.8	3.2	3.6	3.8		
										50	2510	2890	3545	3870	4255	4635	5015	5450	-	-		
										40	2510	2890	3545	3870	4255	4635	5015	5450	-	-		
										30	2685	3095	3795	4145	4555	4960	5370	5835	-	-		
										10 LT	3365	3875	4750	5190	5700	6210	6725	7305	-	-		
										10 HT	2685	3095	3795	4145	4555	4960	5370	5835	-	-		
10 Cyc	-	4125	5285	5795	6720	7370	8065	8760	8895	9265												
Ø 28"	540/65 R 28	142 D/ 145 A8	W 16 L	W 18 L	530	1413	642	4202	675	STD	km/h - bar	0.6	0.8	1.0	1.2	1.4	1.6					
											65	1485	1750	1990	2230	2440	2650					
											50	1560	1840	2090	2340	2565	2785					
											40	1625	1915	2175	2440	2670	2900					
											30	1710	2015	2290	2565	2810	3050					
											10 LT	1995	2350	2670	2990	3275	3555					
10 HT	1710	2015	2290	2565	2810	3050																
Ø 32"	1050/50 R 32	184 A8/ 181 B	36.0 VA	-	1059	1863	826	5700	875	STD	km/h - bar	0.8	1.0	1.4	1.6	2.0	2.4	2.8	3.2	3.4	3.8	
											50	3715	4210	5280	5860	6520	7015	7675	8250	-	-	
											40	4050	4590	5760	6390	7110	7650	8370	9000	-	-	
											30	4335	4915	6165	6840	7610	8190	8960	9630	-	-	
											10 LT	5430	6155	7720	8565	9530	10255	11220	12060	-	-	
											10 HT	4335	4915	6165	6840	7610	8190	8960	9630	-	-	
10 Cyc	-	6810	8725	9565	11095	11555	12645	13595	14195	15300												

Technologies



Performance



STD: Standard





AGRIMAX RT 600

Ø 32"	Tire size	LI/SS	RIM		S.W. (mm)	O.D. (mm)	SLR (mm)	RC (mm)	SRI (index)	Version	Load capacity (kg/tire)										
			Rec.	Alt.							km/h - bar										
											0.8	1.0	1.4	1.6	2.0	2.4	2.8	3.2	3.4	3.8	
650/75 R 32	172 A8/B	DW 21 B	DW 20 B ; DW 23 B	655	1789	807	5416	850	STD	50	2900	3340	4095	4475	4915	5355	5800	6300	-	-	
										40	2900	3340	4095	4475	4915	5355	5800	6300	-	-	
										30	3105	3575	4385	4790	5265	5735	6210	6745	-	-	
										10 LT	3885	4480	5490	6000	6590	7180	7770	8445	-	-	
										10 HT	3105	3575	4385	4790	5265	5735	6210	6745	-	-	
										10 Cyc	-	4770	6105	6695	7765	8515	9320	10125	10285	10710	
800/65 R 32 (30.5L R 32)	181 A8/ 178 B	DW 27 B	DH 27 B ; DW 25 B	775	1820	823	5558	875	STD	50	3175	3660	4485	4900	5385	5865	6350	6900	7500	-	-
										40	3450	3975	4875	5325	5850	6375	6900	7500	8250	-	-
										30	3695	4255	5220	5700	6260	6825	7385	8025	8830	-	-
										10 LT	4625	5330	6535	7140	7840	8545	9250	10050	11055	-	-
										10 HT	3695	4255	5220	5700	6260	6825	7385	8025	8830	-	-
										10 Cyc	-	5655	7230	7960	9250	10140	11055	12025	12440	13000	14000
800/65 R 32 (30.5L R 32)	176 A8/ 173 B	DW 27 B	DH 27 B ; DW 25 B	775	1820	823	5558	875	STD	50	3175	3660	4485	4900	5385	5865	6350	6500	-	-	
										40	3450	3975	4875	5325	5850	6375	6900	7100	-	-	
										30	3695	4255	5220	5700	6260	6825	7385	7600	-	-	
										10 LT	4625	5330	6535	7140	7840	8545	9250	9515	-	-	
										10 HT	3695	4255	5220	5700	6260	6825	7385	7600	-	-	
										10 Cyc	-	5655	7230	7960	9250	10140	11055	11540	12025	12440	
900/60 R 32	181 A8/ 178 B	DW 27 B	DW 28 B ; DW 30 B	896	1893	841	5697	900	STD	50	3375	3825	4350	4800	5325	5925	6375	6975	7500	-	-
										40	3715	4210	4785	5280	5860	6520	7015	7675	8250	-	-
										30	3975	4505	5125	5655	6270	6980	7510	8215	8830	-	-
										10 LT	4975	5640	6415	7080	7850	8735	9400	10285	11055	-	-
										10 HT	3975	4505	5125	5655	6270	6980	7510	8215	8830	-	-
										10 Cyc	-	6765	7690	8485	9415	10475	11270	12330	13255	13465	14025
IF 1250/50 R 32 CFO	201 B	VA44/1.7 (multipiece)	-	1247	2063	897	6136	975	SB	50	6525	7395	9280	10295	11455	12325	13485	14500	-	-	
										40	7115	8065	10120	11225	12490	13435	14700	15805	-	-	
										30	7615	8630	10830	12010	13365	14380	15735	16915	-	---	
										10 LT	9535	10805	13560	15040	16735	18005	19700	21180	-	-	
										10 HT	7615	8630	10830	12010	13365	14380	15735	16915	-	-	
										up to 10 Cyc with front loader*	-	11960	15320	16795	19485	21365	23380	25395	25800	26870	
IF 1250/50 R 32 CFO	201 B	DH44B/1.3 (multipiece)	-	1247	2063	897	6136	975	SB	50	6525	7395	9280	10295	11455	12325	13485	14500	-	-	
										40	7115	8065	10120	11225	12490	13435	14700	15805	-	-	
										30	7615	8630	10830	12010	13365	14380	15735	16915	-	-	
										10 LT	9535	10805	13560	15040	16735	18005	19700	21180	-	-	
										10 HT	7615	8630	10830	12010	13365	14380	15735	16915	-	-	
										10 Cyc	-	11960	15320	16795	19485	21365	23380	25395	25800	26870	

STD: Standard - SB: Steel Belted

*For up to 10 Cyc with front loader application inflation pressure to be increased by 0.8 bar.

Technologies



Reinforced Bead



Rounded Shoulder Technology



More Lugs



IF Technology

Performance



Handling and Comfort



Ideal for grassland



Reduced Soil Compaction



Stability



Traction



HARVESTER

AGRIMAX RT 600

Ø 38"	Tire size	LI/SS	RIM		S.W. (mm)	O.D. (mm)	SLR (mm)	RC (mm)	SRI (index)	Version	Load capacity (kg/tire)											
			Rec.	Alt.							km/h - bar	0.6	0.8	1.0	1.2	1.4	1.6	2.0	2.4			
IF 680/85 R 32 CFO	179 D	DW 23 B	DW 21 B	682	1960	846	5860	925	STD	From 65 to 40	3640	4185	4805	5425	6045	6665	7285	7750				
										30	3785	4350	4995	5640	6285	6930	7575	8060				
										20	3930	4515	5185	5855	6525	7195	7865	8370				
										10	4620	5310	6100	6885	7675	8460	9250	9840				
										Upto 30 Cyc	4730	5440	6245	7050	7855	8660	9470	10075				
										Upto 15 Cyc	5640	6485	7445	8405	9365	10330	11290	12010				
										10 HT	3785	4350	4995	5640	6285	6930	7575	8060				
650/65 R 38	157 D/ 160 A8	DW 20 B	-	645	1811	833	5443	875	STD	km/h - bar	0.6	0.8	1.0	1.2	1.4	1.6						
										65	2310	2725	3095	3465	3795	4125						
										50	2430	2865	3255	3645	3990	4335						
										40	2520	2970	3375	3780	4140	4500						
										30	2660	3135	3560	3990	4370	4745						
										10 LT	3100	3650	4150	4650	5090	5530						
										10 HT	2660	3135	3560	3990	4370	4745						
710/70 R 38	178 D/ 181 A8	DW 23 B	DW 25 B	706	1959	881	5926	925	STD	km/h - bar	0.6	0.8	1.0	1.2	1.4	1.6	2.0	2.4	2.8	3.2		
										65	2925	3450	3975	4425	4950	5400	5925	6375	6975	7500		
										50	3075	3625	4175	4650	5200	5670	6225	6695	7325	7875		
										40	3220	3795	4375	4870	5445	5940	6520	7015	7675	8250		
										30	3365	3970	4575	5090	5695	6210	6815	7335	8025	8625		
										10 LT	3920	4625	5330	5930	6635	7240	7940	8545	9350	10050		
										10 HT	3365	3970	4575	5090	5695	6210	6815	7335	8025	8625		

STD: Standard

Technologies



Reinforced Bead



Rounded Shoulder Technology



More Lugs



IF Technology

Performance



Handling and Comfort



Ideal for grassland



Reduced Soil Compaction



Stability



Traction





HARVESTER

Radial



RM 500

RM 500 is a steel-belted radial tire suitable for harvester implement applications. It features a strong casing and a special tread design providing high load capacity and particular cut-and-chip resistance. Thanks to its large footprint, RM 500 ensures great pressure distribution on the ground with reduced soil compaction in addition to excellent traction.

Ø 24"	Tire size	RIM		S.W. (mm)	O.D. (mm)	SLR (mm)	RC (mm)	SRI (index)	Version	LI/SS Drive Wheel	LI/SS Free Rolling	Load capacity (kg/tire)									
		Rec.	Alt.									km/h - bar									
												0.8	1.0	1.2	1.6	2.0	2.4	2.8			
500/70 R 24	W 16 L	W 15 L	502	1310	572	3907	625	SB	155 A8	167 A8	40 Free Rolling	2290	2620	2945	3600	4145	4800	5450			
												40 Drive Wheel	1630	1860	2095	2560	3945	3410	3875		
												km/h - bar	1.2	1.6	2.0	2.4	2.8	3.2	3.6	4.0	
500/85 R 24	W 16 L	W 15 L	520	1460	622	4382	700	SB	170 A8	182 A8	40 Free Rolling	3570	4335	5015	5780	6545	7055	7735	8500		
												40 Drive Wheel	2520	3060	3540	4080	4620	4980	5460	6000	
												km/h - bar	0.8	1.0	1.2	1.6	2.0	2.4	2.8	3.2	
Ø 28"	500/80 R 28	W 16 L	W 15 L	503	1495	635	4355	700	SB	164 A8	176 A8	40 Free Rolling	2770	3195	3550	4405	5045	5825	6605	7100	
													40 Drive Wheel	1950	2250	2500	3100	3550	4100	4650	5000
													km/h - bar	0.8	1.0	1.2	1.6	2.0	2.4	2.8	3.2
600/65 R 28	W 18 L	W 16 L	590	1486	640	4340	700	SB	156 A8	168 A8	40 Free Rolling	3080	3530	3980	4820	4820	4820	5600			
												40 Drive Wheel	2200	2520	2840	3440	3440	3440	4000		
												km/h - bar	0.8	1.0	1.2	1.6	2.0	2.4	2.8		
600/65 R 28	W 18 L	W 16 L	590	1486	640	4340	700	SB	165 A8	177 A8	40 Free Rolling	3070	3505	3945	4820	5550	6425	7300			
												40 Drive Wheel	2165	2475	2785	3400	3915	4535	5150		
												km/h - bar	0.8	1.0	1.2	1.6	2.0	2.4	2.8		
Ø 30"	500/85 R 30	W 16 L	W 15 L	535	1610	674	4745	775	SB	164 A8	176 A8	40 Free Rolling	2985	3410	3835	4690	5400	6250	7100		
													40 Drive Wheel	2100	2400	2700	3300	3800	4400	5000	
													km/h - bar	0.8	1.0	1.2	1.6	2.0	2.4	2.8	

SB: Steel Belted

Technologies



Performance





HARVESTER

Bias



STAR TRAC

STAR TRAC is the BKT tire for harvesters at cotton farms, which is able to support heavy loads. Thanks to its particularly deep tread design, it ensures both excellent traction in the fields and excellent performance during road transfers. On cotton plantations showing the typical middle-sized shrubs, harvesting demands tire features like excellent flotation and reduced soil compaction. Moreover, the tire is made of a special compound providing high resistance against cuts and typical damages of this application.

Ø 32"	Tire size	LI/SS	RIM		S.W. (mm)	O.D. (mm)	SLR (mm)	RC (mm)	Version	Load capacity (kg/tire)	
			Rec.	Alt.						km/h - bar	
DW 500/95 D 32	162 A8/ 169 A5	13.00 DW	-	500	1836	809	5324	STD	1.70		
									40	4750	
									25	5800	
VA 500/95 D 32	179 A8/ 186 A5	13.00 VA	-	500	1836	809	5324	STD	4.20		
									40	7750	
									25	9500	

STD: Standard

Performance



Bias



HARVESTER



HARVESTER SPECIAL (R-1)

HARVESTER SPECIAL has been specifically designed for harvesters. Its dual -angled lugs provide excellent traction in the fields and a comfortable ride on the road. The special tread design provides a large contact area for extraordinary stability. HARVESTER SPECIAL features a strong casing and a particularly cut-and-chip resistant compound ensuring a longer tire life-cycle.

Ø 25"	Tire size	LI/SS	RIM		S.W. (mm)	O.D. (mm)	SLR (mm)	RC (mm)	Version	PR	Load capacity (kg/tire)	
			Rec.	Alt.							km/h - bar	
23.5 - 25	191 A2	19.50/2.5	-	615	1665	715	5058	DB	20	3.75		
										10	10900	
Ø 26"	23.1 - 26	159 A6	DW 20 B ; DW 20 A	-	587	1585	720	4806	DB	16	2.30	
											30	4375

DB: Dual Bead

Performance





HARVESTER

Bias



COMMANDER (R) (R-1)

COMMANDER (R) is an agricultural tire featuring a deep tread with strong lug bases for a longer tire life-cycle. The special dual-angle lug design provides excellent traction in the fields and top self-cleaning properties. The strong casing is made of a cut-and-chip-resistant compound providing better puncture resistance together with high load capacity. COMMANDER (R) is the perfect tire for soil tillage, haulage and harvesting operations.

Ø 20"	Tire size	RIM		S.W. (mm)	O.D. (mm)	SLR (mm)	RC (mm)	Version	PR	Type	LI/SS	Load capacity (kg/tire)	
		Rec.	Alt.									km/h - bar	3.0
	9.5 - 20	W 8	W 7	245	970	456	2949	STD	12	TT	109 A6	30	1030
	9.5 - 24	W8	W 7	245	1065	507	3308	STD	12	TT	114 A6	30	1150
	11.2 - 24	W 10	W 9	295	1125	533	3483	STD	12	TT	123 A6	30	1550
	12.4 - 24	W 11	W 10	328	1180	569	3669	STD	8	TT	121 A6	30	1450
	12.4 - 24	W 11	W 10	328	1180	569	3669	STD	12	TT	128 A6	30	1800
	12.4 - 28	W 11	W 9; W 10	320	1285	600	3946	STD	12	TT	125 A6	30	1650
	13.6 - 28	W 12	W 11	360	1345	623	4068	STD	12	TT	128 A6	30	1800
	14.9 - 28	W 13	W 11; W 12	388	1380	642	4176	STD	12	TT	134 A6	30	2120
	15.9 - 28	W 13	W 11; W 12	405	1410	-	-	STD	12	TT	140 A6	30	2500
	16.9 - 28	W 15 L	W 14 L	435	1435	663	4274	STD	12	TT	143 A6	30	2725
	16.9 - 28 (21L)	W 15 L	W 14 L	440	1435	-	-	STD	12	TT	143 A6	30	2725

Technologies



Extra Deep Tread

Performance



Cut and Chip Resistance



Durability



High Load Capacity



Self-Cleaning



Traction

STD: Standard





HARVESTER

COMMANDER (R) (R-1)

Ø 28"	Tire size	RIM		S.W. (mm)	O.D. (mm)	SLR (mm)	RC (mm)	Version	PR	Type	LI/SS	Load capacity (kg/tire)	
		Rec.	Alt.									km/h - bar	
	17.9 - 28	W 15 L	W 14 L	458	1515	-	-	STD	12	TT	144 A6	30	2800
													2.20
													2.4
													1.4
													2.6
													3.2
													3.2
													4.20
													1700

Technologies



Extra Deep Tread

Performance



Cut and Chip Resistance



Durability



High Load Capacity



Self-Cleaning



Traction

STD: Standard





HARVESTER

Bias



TR 137

TR 137 is BKT's most suitable tire for all harvesting operations. It ensures excellent traction in the fields even with high loads. The tire is available in different versions: the "aramid-belted" version provides better puncture resistance and protection against all typical damages of this application; the "HD" version provides extraordinary cut and chip resistance, and an extended tire life-cycle.

Ø 32"	Tire size	RIM		S.W. (mm)	O.D. (mm)	SLR (mm)	RC (mm)	Version	PR	Type	LI/SS	Load capacity (kg/tire)	
		Rec.	Alt.									km/h - bar	
24.5 - 32	DW 21 B	DW 20 B	622	1805	807	5343	STD	12	TL	159 A6		30	1.70
													4375
24.5 - 32	DW 21 B	DW 20 B	622	1805	807	5343	STD	14	TL	163 A6		30	2.00
													4875
30.5L - 32	DH 27 B	DW 27 B	770	1865	831	5520	STD	12	TL	162 A6		30	1.40
													4750
30.5L - 32	DH 27 B	DW 27 B	770	1865	831	5520	STD	14	TL	164 A6		30	1.60
													5000
30.5L - 32	DH 27 B	DW 27 B	770	1865	831	5520	STD	16	TL	167 A6		30	1.80
													5450
30.5L - 32	DH 27 B	DW 27 B	770	1865	831	5520	AB	18	TL	170 A6		30	2.10
													6000
30.5L - 32	DH 27 B	DW 27 B	770	1865	831	5520	HD	18	TL	170 A6		30	2.10
													6000

STD: Standard - AB: Aramid Belted - HD: Heavy Duty

Technologies



Reinforced Carcass



Special Compound

Performance



Cut and Chip Resistance



Durability



High Load Capacity



Self-Cleaning



Stubble Resistance



Traction





HARVESTER

 Bias



TR 360

TR 360 is suitable for implement machinery in on-and-off-the-road transport as well as lawn and garden applications. The particular tread design along with the casing structure ensures a long tire life-cycle.

Ø 8"	Tire size	RIM		S.W. (mm)	O.D. (mm)	SLR (mm)	RC (mm)	Version	PR	Type	LI/SS	Load capacity (kg/tire)	
		Rec.	Alt.									km/h - bar	3.10
													
18 X 7 - 8	5.5	-	180	460	202	1334	STD	6	TL	-	15	450	

Performance



Durability

STD: Standard





HARVESTER

Bias



TR 882

TR 882 is a very versatile tire suitable for several applications and vehicles. It has been designed to fit implement machinery, hay harvesters/balers and sugar cane machinery. Engineered with a special compound to reduce damage, this tire features also great durability and traction in every field condition. TR 882 is also available as "aramid-belted", "HD" and "special" versions to meet specific end user requirements.

Ø 15.5"	Tire size	RIM		S.W. (mm)	O.D. (mm)	SLR (mm)	RC (mm)	Version	PR	Type	LI/SS Drive Wheel	LI/SS Free Rolling	Load capacity (kg/tire)	
		Rec.	Alt.										km/h - bar	
400/60 - 15.5	AG 13.00	-	400	875	378	2605	STD	8	TL	122 A8	134 A8	km/h - bar	2.40	
												10 FR	2970	
												25 FR	2525	
												30 FR	2375	
												40 FR	2120	
												10 DW	2100	
												25 DW	1785	
												30 DW	1680	
40 DW	1500													
400/60 - 15.5	AG 13.00	-	400	875	378	2605	STD	14	TL	132 A8	145 A8	km/h - bar	3.60	
												10 FR	4060	
												25 FR	3450	
												30 FR	3250	
												40 FR	2900	
												10 DW	2800	
												25 DW	2380	
												30 DW	2240	
40 DW	2000													
400/60 - 15.5	AG 13.00	-	400	875	378	2605	STD	18	TL	137 A8	149 A8	km/h - bar	4.50	
												10 FR	4550	
												25 FR	3870	
												30 FR	3640	
												40 FR	3250	
												10 DW	3220	
												25 DW	2735	
												30 DW	2575	
40 DW	2300													
400/60 - 15.5	AG 13.00	-	400	875	378	2605	AB	14	TL	132 A8	145 A8	km/h - bar	3.60	
												10 FR	4060	
												25 FR	3450	
												30 FR	3250	
												40 FR	2900	
												10 DW	2800	
												25 DW	2380	
												30 DW	2240	
40 DW	2000													

STD: Standard - AB: Aramid Belted

Technologies



Heavy Duty



Special Compound



Aramid Belted

Performance



Cut and Chip Resistance



Durability



Stubble Resistance



Traction





TR 882

Ø 15.5"	Tire size	RIM		S.W. (mm)	O.D. (mm)	SLR (mm)	RC (mm)	Version	PR	Type	LI/SS Drive Wheel	LI/SS Free Rolling	Load capacity (kg/tire)	
		Rec.	Alt.										km/h - bar	
400/60 - 15.5	AG 13.00	-	400	875	378	2605	AB HD	18	TL	137 A8	149 A8	km/h - bar	4.50	
												10 FR	4550	
												25 FR	3870	
												30 FR	3640	
												40 FR	3250	
												10 DW	3220	
												25 DW	2735	
												30 DW	2575	
40 DW	2300													
400/60 - 15.5	AG 13.00	-	400	875	378	2605	HD	14	TL	132 A8	145 A8	km/h - bar	3.60	
												10 FR	4060	
												25 FR	3450	
												30 FR	3250	
												40 FR	2900	
												10 DW	2800	
												25 DW	2380	
												30 DW	2240	
40 DW	2000													
400/60 - 15.5	AG 13.00	-	400	875	378	2605	HD	18	TL	137 A8	149 A8	km/h - bar	4.50	
												10 FR	4550	
												25 FR	3870	
												30 FR	3640	
												40 FR	3250	
												10 DW	3220	
												25 DW	2735	
												30 DW	2575	
40 DW	2300													
400/60 - 15.5	AG 13.00	-	400	875	378	2605	SPL	14	TL	132 A8	145 A8	km/h - bar	3.60	
												10 FR	4060	
												25 FR	3450	
												30 FR	3250	
												40 FR	2900	
												10 DW	2800	
												25 DW	2380	
												30 DW	2240	
40 DW	2000													
400/60 - 15.5	AG 13.00	-	400	875	378	2605	SPL	18	TL	137 A8	149 A8	km/h - bar	4.50	
												10 FR	4550	
												25 FR	3870	
												30 FR	3640	
												40 FR	3250	
												10 DW	3220	
												25 DW	2735	
												30 DW	2575	
40 DW	2300													

AB HD: Aramid Belted HD - HD: Heavy Duty - SPL: Special

Technologies



Heavy Duty



Special Compound



Aramid Belted

Performance



Cut and Chip Resistance



Durability



Stubble Resistance



Traction



HARVESTER

Bias



FLOTATION 558

FLOTATION 558 is a cross-ply flotation tire suitable for hay harvesters/balers, tankers and trailers both on and off the road. It is particularly recommended whenever traction is essential for good soil tillage in addition to high load capacity.

Ø 22.5"	Tire size	RIM		S.W. (mm)	O.D. (mm)	SLR (mm)	RC (mm)	Version	PR	Type	LI/SS Drive Wheel	LI/SS Free Rolling	Load capacity (kg/tire)			
		Rec.	Alt.										km/h - bar			
													4.60	4.80	5.00	
400/55 - 22.5	AG 11.75	12.25 ; 13.00 ; AG 13.00	405	1020	445	3084	STD	20	TL	144 A8/140 B	156 A8/152 B	10 FR	5335	5465	5600	
												20 FR	4800	4920	5040	
												30 FR	4265	4375	4480	
												40 FR	3810	3905	4000	
												50 FR	3430	3515	3550	
												10 DW	3730	3830	3920	
												20 DW	3360	3445	3530	
												30 DW	2985	3065	3135	
												40 DW	2665	2735	2800	
												50 DW	2400	2460	2500	
400/55 - 22.5	AG 11.75	12.25 ; 13.00 ; AG 13.00	405	1020	445	3084	STD	14	TL	138 A8/134 B	150 A8/146 B	10 FR	4285	4450	4690	
												20 FR	3855	4005	4220	
												30 FR	3425	3560	3750	
												40 FR	3060	3180	3350	
												50 FR	2755	2860	3000	
												10 DW	3015	3135	3305	
												20 DW	2715	2820	2975	
												30 DW	2415	2510	2645	
												40 DW	2155	2240	2360	
												50 DW	1940	2015	2120	
400/55 - 22.5	AG 11.75	12.25 ; 13.00 ; AG 13.00	405	1020	445	3084	STD	16	TL	140 A8/136 B	152 A8/148 B	10 FR	4745	4825	4970	
												20 FR	4270	4340	4475	
												30 FR	3795	3860	3975	
												40 FR	3390	3445	3550	
												50 FR	3050	3100	3150	
												10 DW	3345	3395	3500	
												20 DW	3010	3055	3150	
												30 DW	2675	2715	2800	
												40 DW	2390	2425	2500	
												50 DW	2150	2185	2240	

STD: Standard

Performance





FLOTATION 558

Ø 22.5"	Tire size	RIM		S.W. (mm)	O.D. (mm)	SLR (mm)	RC (mm)	Version	PR	Type	LI/SS Drive Wheel	LI/SS Free Rolling	Load capacity (kg/tire)		
		Rec.	Alt.										km/h - bar		
													3.70	3.80	4.00
400/55 - 22.5	AG 11.75	12.25 ; 13.00 ; AG 13.00	405	1020	445	3084	AB HD	16	TL	140 A8/136 B	152 A8/148 B	10 FR	4745	4825	4970
												20 FR	4270	4340	4475
												30 FR	3795	3860	3975
												40 FR	3390	3445	3550
												50 FR	3050	3100	3150
												10 DW	3345	3395	3500
												20 DW	3010	3055	3150
												30 DW	2675	2715	2800
												40 DW	2390	2425	2500
												50 DW	2150	2185	2240
500/45 - 22.5	AG 16.00	-	500	1045	471	3167	STD	20	TL	146 A8/142 B	158 A8/154 B	10 FR	5795	5875	5950
												20 FR	5215	5285	5355
												30 FR	4635	4700	4760
												40 FR	4140	4195	4250
												50 FR	3725	3775	3750
												10 DW	4090	4145	4200
												20 DW	3680	3730	3780
												30 DW	3270	3315	3360
												40 DW	2920	2960	3000
												50 DW	2630	2665	2650
500/45 - 22.5	AG 16.00	-	500	1045	471	3167	STD	12	TL	136 A8/132 B	148 A8/144 B	10 FR	4020	4215	4410
												20 FR	3615	3795	3970
												30 FR	3215	3370	3530
												40 FR	2870	3010	3150
												50 FR	2585	2710	2800
												10 DW	2855	2995	3135
												20 DW	2570	2695	2820
												30 DW	2285	2395	2510
												40 DW	2040	2140	2240
												50 DW	1835	1925	2000
500/45 - 22.5	AG 16.00	-	500	1045	471	3167	STD	16	TL	142 A8/138 B	154 A8/150 B	10 FR	4900	5075	5250
												20 FR	4410	4570	4725
												30 FR	3920	4060	4200
												40 FR	3500	3625	3750
												50 FR	3150	3265	3350
												10 DW	3465	3590	3710
												20 DW	3120	3230	3340
												30 DW	2770	2875	2970
												40 DW	2475	2565	2650
												50 DW	2230	2310	2360

STD: Standard - AB HD: Aramid Belted HD

Performance



Durability



High Load Capacity



Traction





HARVESTER

FLOTATION 558

∅ 22.5"	Tire size	RIM		S.W. (mm)	O.D. (mm)	SLR (mm)	RC (mm)	Version	PR	Type	LI/SS Drive Wheel	LI/SS Free Rolling	Load capacity (kg/tire)		
		Rec.	Alt.										km/h - bar	3.20	3.40
500/45 - 22.5	AG 16.00	-	500	1045	471	3167	AB HD	16	TL	142 A8/138 B	154 A8/150 B	10 FR	4900	5075	5250
												20 FR	4410	4570	4725
												30 FR	3920	4060	4200
												40 FR	3500	3625	3750
												50 FR	3150	3265	3350
												10 DW	3465	3590	3710
												20 DW	3120	3230	3340
												30 DW	2770	2875	2970
												40 DW	2475	2565	2650
												50 DW	2230	2310	2360

Performance



Durability



High Load Capacity



Traction

AB HD: Aramid Belted HD





HARVESTER

 Bias



BK 308

BK 308 has been specially designed for trailers and utility tractors. It features excellent traction on all surfaces and tread tie bars to reduce tread groove cracking. The strong casing provides excellent durability and puncture resistance whereas the special tread compound ensures a longer service life.

Ø 20"	Tire size	RIM		S.W. (mm)	O.D. (mm)	SLR (mm)	RC (mm)	Version	PR	Type	LI/SS	Load capacity (kg/tire)	
		Rec.	Alt.									km/h - bar	
	6.50 - 20	5.50 F	4.00 E ; 5.00 F	190	865	-	-	STD	10	TT	112 A6	30	4.8 1120

STD: Standard

Performance



Durability



High Puncture Resistance



Traction





PIVOT IRRIGATOR





AGRIMAX RI 818

AGRIMAX RI 818 is a radial tire, which has been specifically developed for irrigation applications with pivot irrigators. Its specially designed tread pattern provides excellent traction in wet and muddy conditions in addition to outstanding self-cleaning properties.



Ø 24"	Tire size	LI/SS	RIM		S.W. (mm)	O.D. (mm)	SLR (mm)	RC (mm)	SRI (index)	Version	Load capacity (kg/tire)	
			Rec.	Alt.							km/h - bar	1.6
	280/85 R 24 (11.2 R 24)	140	W 10	W 9	287	1086	490	3271	525	STD	CREEP	2500

Ø 38"	Tire size	LI/SS	W 10	W 9; W 11	319	1509	691	4565	725	STD	Load capacity (kg/tire)	
											km/h - bar	1.6
	320/85 R 38 (12.4 R 38)	154									CREEP	3750

Performance



STD: Standard

TR 117 (R-1)



TR 117 is ideal for irrigation applications with pivot irrigators. Its specially designed tread pattern provides excellent traction and outstanding self-cleaning properties.

Ø 24"	Tire size	RIM		S.W. (mm)	O.D. (mm)	SLR (mm)	RC (mm)	Version	PR	Type	LI/SS	Load capacity (kg/tire)		
		Rec.	Alt.									km/h - bar	1.20	1.55
													30	30
11.2 - 24	W 10	W 9	284	1090	509	3205	STD	4	TT	101 A6	km/h - bar	1.20	1.55	
											30	825	-	
											CREEP	-	1585	
11.2 - 24	W 10	W 9	284	1090	509	3205	STD	4	TL	101 A6	km/h - bar	1.20	1.55	
											30	825	-	
											CREEP	-	1585	
11.2 - 24	W 10	W 9	284	1090	509	3205	STD	6	TT	110 A6	km/h - bar	1.80	2.35	
											30	1060	-	
											CREEP	-	2005	
11.2 - 24	W 10	W 9	284	1090	509	3205	STD	6	TL	110 A6	km/h - bar	1.80	2.35	
											30	1060	-	
											CREEP	-	2005	
13.6 - 24	W 12	W 11	350	1187	541	3591	STD	6	TT	119 A6	km/h - bar	2.20	2.85	
											30	1360	-	
											CREEP	-	2565	
13.6 - 24	W 12	W 11	350	1187	541	3591	STD	6	TL	119 A6	km/h - bar	2.20	2.85	
											30	1360	-	
											CREEP	-	2565	
14.9 - 24	W 13	W 11 ; W 12	378	1245	575	3660	STD	4	TT	112 A6	km/h - bar	0.80	1.05	
											30	1120	-	
											CREEP	-	2175	
14.9 - 24	W 13	W 11 ; W 12	378	1245	575	3660	STD	4	TL	112 A6	km/h - bar	0.80	1.05	
											30	1120	-	
											CREEP	-	2175	
14.9 - 24	W 13	W 11 ; W 12	378	1245	575	3660	STD	6	TT	123 A6	km/h - bar	1.40	1.80	
											30	1550	-	
											CREEP	-	2870	
14.9 - 24	W 13	W 11 ; W 12	378	1245	575	3660	STD	6	TL	123 A6	km/h - bar	1.40	1.80	
											30	1550	-	
											CREEP	-	2870	

STD: Standard

CREEP SPEED - 200 FT/30 MIN (61 M/30 MIN)

Performance



Ø 24"	Tire size	RIM		S.W. (mm)	O.D. (mm)	SLR (mm)	RC (mm)	Version	PR	Type	LI/SS	Load capacity (kg/tire)			
		Rec.	Alt.									km/h - bar	1.80	2.35	
												30	1800	-	
14.9 - 24	W13	W11; W12	378	1245	575	3660	STD	8	TT	128 A6		km/h - bar	1.80	2.35	
												30	1800	-	
												CREEP	-	3375	
14.9 - 24	W13	W11; W12	378	1245	575	3660	STD	8	TL	128 A6		km/h - bar	1.80	2.35	
												30	1800	-	
												CREEP	-	3375	
14.9 - 24	W13	W11; W12	378	1245	575	3660	HD	8	TL	128 A6		km/h - bar	1.80	2.35	
												30	1800	-	
												CREEP	-	3375	
Ø 38"	Tire size	Rec.	Alt.	S.W. (mm)	O.D. (mm)	SLR (mm)	RC (mm)	Version	PR	Type	LI/SS		km/h - bar	1.30	1.70
													30	1030	-
													CREEP	-	2005
11.2 - 38	W10	W9	284	1445	675	4400	STD	4	TT	109 A6		km/h - bar	1.30	1.70	
												30	1030	-	
												CREEP	-	2005	
11.2 - 38	W10	W9	284	1445	675	4400	STD	4	TL	109 A6		km/h - bar	1.30	1.70	
												30	1030	-	
												CREEP	-	2005	
11.2 - 38	W10	W9	284	1445	675	4400	STD	6	TT	117 A6		km/h - bar	1.80	2.35	
												30	1285	-	
												CREEP	-	2425	
11.2 - 38	W10	W9	284	1445	675	4400	STD	6	TL	117 A6		km/h - bar	1.80	2.35	
												30	1285	-	
												CREEP	-	2425	

HD: Heavy Duty - STD: Standard

CREEP SPEED - 200 FT/30 MIN (61 M/30 MIN)

Performance





TR 118 (R-1)

TR 118 has been engineered for irrigation machinery. TR 118 features a reinforced carcass and a higher number of lugs, which enable a longer service life.

Ø 24"	Tire size	RIM		S.W. (mm)	O.D. (mm)	SLR (mm)	RC (mm)	Version	PR	Type	LI/SS	Load capacity (kg/tire)		
		Rec.	Alt.									km/h - bar	1.80	2.35
	14.9 - 24	W 13	W 12 ; W 11	380	1265	566	3742	STD	8	TL	128 A6	30	1800	-
												CREEP	-	3375

STD: Standard

CREEP SPEED - 200 FT/30 MIN (61 M/30 MIN)

Technologies



Reinforced Carcass

Performance



Durability

FLOTATION





FLOTATION

Radial



V-FLEXA

V-FLEXA is a radial tire specifically designed for agricultural trailers. It is a latest-generation flotation product featuring VF technology, which enables the transport of heavy loads both in the fields and on the road with an inflation pressure that is 30% less than that of a standard tire of the same size. Additional steel belts confer major resistance to the casing against impacts. Not only does V-FLEXA support heavy loads in full safety, it also avoids soil compaction thanks to perfect weight distribution. Moreover, V-FLEXA features great self-cleaning properties, durability as well as low rolling resistance.

Ø 22.5"	Tire size	LI/SS	RIM		S.W. (mm)	O.D. (mm)	SLR (mm)	RC (mm)	SRI (index)	Version	Load capacity (kg/tire)							
			Rec.	Alt.							km/h - bar	0.8	1.2	1.6	2.0	2.4	2.8	3.2
VF 560/60 R 22.5	166 D	AG 16.00	-	555	1250	550	3756	600	SB	70	2075	2655	3185	3670	3910	4440	4825	
										65	2280	2915	3500	4030	4295	4880	5300	
										50	2670	3415	4100	4720	5030	5710	6205	
										40	2945	3765	4515	5200	5545	6295	6840	
										10	3740	4785	5740	6610	7045	8000	8695	
										70	2130	2725	3315	3765	4360	4955		
VF 600/55 R 26.5	167 D	AG 20.00	-	615	1342	580	3986	650	SB	70	2130	2725	3315	3765	4360	4955		
										65	2340	2995	3650	4140	4795	5450		
										50	2740	3505	4270	4845	5610	6375		
										40	3020	3865	4710	5340	6185	7030		
										10	3840	4910	5985	6790	7860	8935		
										70	2470	3155	3845	4360	5050	5735		
VF 600/65 R 26.5	172 D	AG 20.00	-	615	1453	628	4377	700	SB	70	2470	3155	3845	4360	5050	5735		
										65	2710	3465	4225	4790	5545	6300		
										50	3175	4060	4945	5605	6490	7375		
										40	3500	4475	5450	6180	7155	8130		
										10	4445	5685	6925	7855	9095	10335		
										70	2405	3075	3745	4250	4920	5595		
VF 650/55 R 26.5	171 D	AG 20.00	-	644	1389	591	4100	650	SB	70	2405	3075	3745	4250	4920	5595		
										65	2640	3380	4120	4670	5410	6150		
										50	3090	3955	4820	5465	6330	7195		
										40	3405	4360	5310	6025	6975	7930		
										10	4335	5545	6755	7660	8870	10085		
										70	2590	3300	3880	4530	5110	5820	6465	
VF 710/50 R 26.5	176 D	AG 24.00	-	727	1383	600	4193	650	SB	70	2590	3300	3880	4530	5110	5820	6465	
										65	2840	3625	4260	4970	5610	6390	7100	
										50	3325	4240	4990	5820	6565	7480	8310	
										40	3665	4675	5500	6415	7240	8245	9160	
										10	4660	5940	6990	8155	9200	10485	11645	
										70	2590	3300	3880	4530	5110	5820	6465	
VF 750/45 R 26.5	176 D	AG 24.00	-	755	1349	585	4095	650	SB	70	2590	3300	3880	4530	5110	5820	6465	
										65	2840	3625	4260	4970	5610	6390	7100	
										50	3325	4240	4990	5820	6565	7480	8310	
										40	3665	4675	5500	6415	7240	8245	9160	
										10	4660	5940	6990	8155	9200	10485	11645	
										70	2590	3300	3880	4530	5110	5820	6465	

SB: Steel Belted

Technologies



Performance





V-FLEXA

Ø 30.5"	Tire size	LI/SS	RIM		S.W. (mm)	O.D. (mm)	SLR (mm)	RC (mm)	SRI (index)	Version	Load capacity (kg/tire)							
			Rec.	Alt.							km/h - bar	0.8	1.2	1.6	2.0	2.4	2.8	3.2
VF 710/50 R 30.5	178 D	AG 24.00	-	727	1485	654	4511	700	SB	70	2730	3485	4095	4780	5395	6145	6825	
										65	3000	3825	4500	5250	5925	6750	7500	
										50	3510	4480	5265	6145	6935	7900	8775	
										40	3870	4935	5805	6775	7645	8710	9675	
										10	4920	6275	7380	8610	9720	11070	12300	
VF 750/60 R 30.5	187 D	AG 24.00	-	780	1678	728	5085	800	SB	70	3550	4530	5325	6215	7015	7990	8875	
										65	3900	4975	5850	6825	7705	8775	9750	
										50	4565	5820	6850	7990	9015	10270	11410	
										40	5035	6420	7550	8810	9940	11325	12580	
										10	6400	8155	9595	11195	12635	14395	15990	

SB: Steel Belted

Technologies



High Speed



Reinforced Bead



VF Technology



Extra Steel Belted

Performance



Durability



High Load Capacity



Low Rolling Resistance



Reduced Soil Compaction



Self-Cleaning



Traction



FLOTATION

Radial



RIDEMAX FL 699

RIDEMAX FL 699 is the perfect BKT tire for road applications with trailers and tank trucks. This All Steel tire stands out for its high mileage and durability. The reinforced bead ensures better stability even at high speeds. Even if this radial tire has been designed for a 90% on-the-road usage, i.e. for transport in farming applications, the new RIDEMAX FL 699 also provides excellent performance in the fields. The tire has been designed with a particular focus on load capacity to decrease the number of transport cycles. Good news also to farmers who know the sensation when a trailer seems to compromise driving; RIDEMAX FL 699 ensures an extraordinarily comfortable ride providing safety and driving control.

RIDEMAX
RADIAL TRANSPORT TIRES

Ø 20.5"	Tire size	LI/SS	RIM		O.W. (mm)	O.D. (mm)	SLR (mm)	RC (mm)	SRI (index)	Version	Load capacity (kg/tire)	
			Rec.	Alt.							km/h - bar	
24 R 20.5	176 F	18.00	-	590	1370	613	4165	-	STD	80	6.0	7100
525/65 R 20.5	173 F	16.00	-	518	1200	544	3678	-	STD	80	8.00	6500

STD: Standard

Technologies



High Speed



Reinforced Bead



All Steel

Performance



Cut and Chip Resistance



Durability



High Load Capacity



High Mileage



Stability





FLOTATION

Radial



FL 634 PERFORMA

The new FL 634 PERFORMA is an All Steel radial tire that meets the growing demand for logistics in agriculture. Specifically designed for vehicles such as agro trucks and tank trucks, this tire embodies great efficiency and versatility making it suitable for transport operations from the harvest field to the processing or any other farm area. Engineered for high-speed performance, it ensures excellent roadability on asphalt along with smooth and rapid transportation, an essential need in modern agriculture. The innovative open shoulder and tread design significantly enhance tire traction both on the road and in the fields providing outstanding self-cleaning properties. The tread compound, the specific construction features, and a strong steel body ply with four steel belts make FL 634 PERFORMA synonym for robustness and resistance to any kind of damage ensuring a long service life. In addition, the bead has been reinforced with a steel chafer that ensures high clamping stability in any operation mode.

Ø 22.5"	Tire size	LI/SS	RIM		O.W. (mm)	O.D. (mm)	SLR (mm)	RC (mm)	SRI (index)	Version	Load capacity (kg/tire)	
			Rec.	Alt.							km/h - bar	
											6.50	
	600/50 R 22.5	164 J	AG 20.00	-	615	1170	535	3567	-	STD	40	5750
											100	5000

STD: Standard

Technologies



All Steel



High Speed



Directional Tread Pattern

Performance



Durability



High Load Capacity



Multi-Purpose Tires



Self-Cleaning



Traction





FLOTATION

Radial



FL 633 PERFORMA

The new All Steel radial tire FL 633 PERFORMA perfectly combines the needs of several agricultural applications with the growing demand for logistics in agriculture. Specifically designed for agro trucks, FL 633 PERFORMA is the innovative solution that enhances both tractor and truck performance features to meet the special needs of modern farming. Thanks to its very strong casing, exceptional load capacity and durability, FL 633 PERFORMA signs the "next level" of flotation tires being suitable for multiple activities in the fields and even for travel on highways reaching up to 100 km/h.

Ø 22.5"	Tire size	LI/SS	RIM		O.W. (mm)	O.D. (mm)	SLR (mm)	RC (mm)	SRI (index)	Version	Load capacity (kg/tire)	
			Rec.	Alt.							km/h - bar	6.50
	600/50 R 22.5	164 J	AG 20.00	-	590	1170	534	3559	-	STD	100	5000

STD: Standard

Technologies



High Speed



All Steel



Strong Casing

Performance



Durability



High Load Capacity



Multi-Purpose Tires



Self-Cleaning



RIDEMAX FL 690

RIDEMAX FL 690 is a radial flotation and transport tire for tank trucks and trailers. The tire is suitable for 75% on-the-road applications. As a response to the increasing demand for high loads in modern agriculture, BKT has designed this steel-belted tire withstanding very heavy loads and increasing the farmer's productivity. The low rolling resistance contributes to better fuel economy.



Ø 26"	Tire size	LI/SS	RIM		S.W. (mm)	O.D. (mm)	SLR (mm)	RC (mm)	SRI (index)	Version	Load capacity (kg/tire)							
			Rec.	Alt.							km/h - bar	0.8	1.0	1.4	1.6	2.0	2.4	2.8
28L R 26 (750/65 R 26)	176 A8/ 173 B	DW 25 B DW 23 B	719	1590	695	4745	750	STD	50	3120	3560	4325	4680	5330	5915	6500		
									40	3410	3885	4725	5115	5825	6465	7100		
									30	3820	4355	5295	5730	6525	7240	7955		
									25	4060	4625	5620	6085	6930	7690	8450		
									10	4775	5440	6615	7160	8155	9050	9940		
Ø 32"	30.5L R 32	184 A8/ 181 B	DH 27 B DW 27 B	790	1800	806	5430	875	STD	50	3795	4375	5280	5695	6520	7260	7920	8250
										40	4370	5030	6075	6550	7500	8355	9115	9490
										30	4935	5685	6865	7405	8475	9440	10300	10725
										25	5205	5995	7240	7805	8935	9950	10855	11305
										10	6040	6955	8400	9055	10365	11550	12600	13120
800/60 R 32	185 D	DH 27 B DW 27 B	800	1800	817	5454	850	STD	70	2695	3455	4295	4885	5645	6400	6990	7665	8420
									65	2960	3795	4720	5365	6200	7030	7680	8420	9250
									50	3585	4590	5710	6495	7505	8510	9295	10190	11195
									40	4030	5160	6420	7300	8430	9565	10445	11450	12580
									30	4475	5730	7125	8105	9360	10620	11600	12715	13970
									25	4680	5995	7455	8480	9795	11110	12135	13300	14615
VF 900/65 R 32 (VF35.5LR32)	197 D	DW 31 B DW 30 ; TW 30	930	1986	838	5878	925	STD	70	5030	6435	7840	8890	10295	11695			
									65	5530	7070	8610	9770	11310	12850			
									50	6470	8270	10075	11430	13235	15035			
									40	7130	9120	11110	12605	14595	16580			
									10	9065	11595	14125	16020	18550	21075			

Technologies



Performance



STD: Standard

RIDEMAX FL 693 M

RIDEMAX FL 693 M is the ideal radial tire for those who frequently travel on the road with trailers/tank trucks. Actually designed for 75% on-the-road use, RIDEMAX FL 693 M provides excellent road performance prioritizing both comfort and self-cleaning properties. The speed index classes D/E of the range stands for higher speeds when travelling on the road leading to significant time savings. The low rolling resistance contributes to less fuel consumption, while a reinforced bead and steel belts ensure enhanced durability.

RIDEMAX
RADIAL TRANSPORT TIRES



Ø 17"	Tire size	LI/SS	RIM		S.W. (mm)	O.D. (mm)	SLR (mm)	RC (mm)	SRI (index)	Version	Load capacity (kg/tire)											
			Rec.	Alt.							km/h - bar											
											0.8	1.2	1.6	2.0	2.4	2.8	3.2	3.6	4.0			
425/55 R 17	129 D/140 A8	13.00	-	420	894	397	2704	425	STD	65	595	760	945	1075	1240	1410	1540	1685	1850			
										50	720	920	1145	1300	1505	1705	1860	2040	2240			
										40	800	1025	1275	1450	1675	1900	2075	2275	2500			
										30	895	1150	1430	1625	1875	2125	2320	2545	2795			
										25	940	1200	1495	1700	1960	2225	2430	2665	2925			
										10	1070	1370	1700	1935	2235	2535	2765	3035	3330			
500/50 R 17	149 D/146 E	16.00	-	503	932	424	2913	450	STD	70	990	1110	1350	1530	1770	2010	2220	2430	2670	3000		
										65	1075	1205	1465	1660	1920	2180	2405	2635	2895	3250		
										50	1305	1460	1775	2010	2325	2640	2915	3190	3505	3935		
										40	1465	1640	1990	2255	2610	2965	3275	3585	3935	4420		
										25	1695	1900	2315	2620	3030	3445	3800	4160	4575	5135		
										10	1935	2165	2635	2985	3455	3920	4330	4740	5210	5850		
VF 500/50 R 17	156 D	16.00	-	503	932	422	2880	450	STD	70	1095	1385	1675	1860	2150	2440	2695	2950	3240	3460	3640	
										65	1200	1520	1840	2040	2360	2680	2960	3240	3560	3800	4000	
										50	1455	1840	2230	2470	2860	3245	3585	3925	4310	4600	4840	
										40	1635	2070	2505	2775	3210	3645	4030	4410	4845	5170	5440	
										25	1900	2405	2910	3225	3730	4235	4680	5120	5625	6005	6320	
										10	2160	2740	3315	3675	4250	4825	5330	5835	6410	6840	7200	
Ø 17.5"	400/45 R 17.5	139 D	14.00	-	400	800	343	2357	390	STD	70	555	710	890	1000	1155	1310	1440	1575	1730	1950	2215
											65	610	780	975	1095	1265	1435	1580	1730	1900	2140	2430
											50	740	945	1180	1330	1535	1740	1915	2095	2300	2595	2945
											40	830	1060	1325	1490	1720	1950	2150	2350	2580	2910	3305
											30	920	1175	1470	1655	1910	2170	2390	2610	2865	3230	3670
											25	960	1230	1540	1730	2000	2270	2500	2730	3000	3380	3840
VF 400/45 R 17.5	142 D	14.00	-	400	800	357	2448	390	STD	70	1040	1260	1405	1620	1840	2005	2200	2415	2650	3010		
										65	1140	1380	1540	1780	2015	2200	2415	2650	2925	3210		
										50	1385	1670	1865	2155	2440	2665	2925	3210	3505	3810		
										40	1555	1875	2095	2420	2740	2995	3285	3605	3945	4305		
										30	1725	2085	2325	2685	3045	3325	3645	4005	4385	4775		
										25	1805	2180	2435	2810	3185	3480	3815	4190	4585	4990		
10	2055	2485	2770	3200	3630	3960	4345	4745	5160	5590												

STD: Standard

Technologies



Performance





FLOTATION

RIDEMAX FL 693 M

Ø 22.5"	Tire size	LI/SS	RIM		S.W. (mm)	O.D. (mm)	SLR (mm)	RC (mm)	SRI (index)	Version	Load capacity (kg/tire)												
			Rec.	Alt.							km/h - bar												
											1.0	1.2	1.6	2.0	2.4	2.8	3.2	3.6	4.0				
500/45 R 22.5	146 D/ 143 E	AG 16.00	-	503	1022	455	3114	500	STD	70	1000	1120	1390	1585	1830	2075	2265	2480	2725				
										65	1095	1230	1530	1740	2010	2280	2490	2730	3000				
										50	1330	1490	1855	2110	2435	2760	3015	3305	3630				
										40	1495	1675	2085	2370	2735	3105	3390	3715	4080				
										25	1735	1945	2420	2750	3180	3605	3935	4315	4740				
										10	1975	2215	2755	3135	3620	4105	4485	4915	5400				
500/60 R 22.5	155 D/ 152 E	AG 16.00	15.00 ; 17.00	503	1172	531	3577	550	STD	70	1320	1495	1775	2095	2400	2665	2985	3270	3550				
										65	1435	1630	1940	2290	2620	2910	3255	3565	3875				
										50	1740	1970	2345	2770	3170	3520	3940	4315	4690				
										40	1955	2215	2635	3110	3560	3955	4430	4850	5270				
										25	2270	2575	3065	3615	4135	4595	5145	5635	6125				
										10	2585	2930	3490	4120	4710	5235	5860	6420	6975				
500/60 R 22.5	163 D	AG 16.00	15.00 ; 17.00	503	1172	544	3625	550	STD	70	1470	1825	2000	2310	2620	2890	3155	3465	3690	3910	4175	4440	
										65	1610	2000	2195	2535	2880	3170	3465	3805	4050	4290	4585	4875	
										50	1950	2420	2655	3070	3485	3835	4190	4605	4900	5195	5550	5900	
										40	2190	2720	2985	3450	3915	4310	4710	5175	5505	5835	6235	6630	
										25	2545	3160	3470	4010	4550	5010	5475	6010	6400	6785	7245	7705	
										10	2900	3600	3950	4565	5180	5705	6235	6845	7285	7725	8250	8775	
560/45 R 22.5	152 D/ 149 E	AG 16.00	-	543	1076	491	3306	525	STD	70	1205	1365	1625	1920	2195	2440	2730	2990	3250				
										65	1320	1495	1775	2095	2400	2665	2985	3270	3550				
										50	1595	1810	2150	2540	2905	3225	3615	3960	4300				
										40	1790	2030	2415	2850	3265	3625	4060	4445	4830				
										25	2080	2360	2805	3310	3790	4210	4715	5165	5610				
										10	2365	2685	3195	3775	4315	4795	5370	5880	6390				
560/45 R 22.5	160 D	AG 16.00	-	543	1076	491	3306	525	STD	70	990	1320	1650	1860	2145	2435	2685	2930	3220	3425	3630	3880	4125
										65	1080	1440	1800	2025	2340	2655	2925	3195	3510	3735	3960	4230	4500
										50	1310	1745	2180	2455	2835	3215	3540	3870	4250	4520	4795	5120	5445
										40	1470	1960	2450	2755	3185	3615	3980	4350	4775	5080	5390	5755	6120
										30	1635	2175	2720	3060	3535	4010	4420	4825	5305	5640	5980	6390	6795
										25	1710	2280	2845	3200	3700	4195	4625	5050	5550	5905	6260	6685	7110
10	1945	2595	3240	3645	4215	4780	5265	5755	6320	6725	7130	7615	8100										
560/55 R 22.5	158 D/ 155 E	AG 16.00	17.00 ; 20.00	543	1180	533	3614	550	STD	70	1435	1630	1940	2290	2620	2910	3255	3565	3875				
										65	1575	1785	2125	2510	2870	3190	3570	3910	4250				
										50	1910	2165	2575	3040	3475	3860	4325	4735	5145				
										40	2140	2430	2890	3415	3905	4335	4860	5320	5780				
										25	2490	2825	3360	3965	4535	5040	5645	6180	6715				
										10	2835	3215	3825	4515	5165	5740	6430	7040	7650				
560/55 R 22.5	162 D	AG 16.00	17.00 ; 20.00	543	1180	533	3614	550	STD	70	1645	1990	2205	2555	2900	3200	3505	3850	4110	4325			
										65	1805	2185	2425	2805	3185	3515	3850	4230	4515	4750			
										50	2185	2645	2935	3395	3855	4255	4660	5120	5465	5750			
										40	2455	2975	3295	3815	4330	4785	5235	5750	6140	6460			
										25	2855	3455	3830	4430	5030	5555	6080	6680	7130	7505			
										10	3250	3935	4365	5045	5730	6330	6930	7610	8125	8550			

Technologies



Block Pattern



High Speed



Reinforced Bead



Steel Belted



VF Technology

Performance



Durability



Fuel Economy



Road Oriented



Self-Cleaning

STD: Standard



FLOTATION

RIDEMAX FL 693 M

Ø 22.5"	Tire size	LI/SS	RIM		S.W. (mm)	O.D. (mm)	SLR (mm)	RC (mm)	SRI (index)	Version	Load capacity (kg/tire)									
			Rec.	Alt.							km/h - bar									
											1.2	1.6	2.0	2.4	2.8	3.2	3.6	4.0	5.0	6.0
560/60 R 22.5	169 D	AG 16.00	16.00 ; 17.00 ; AG 20.00	543	1244	552	3767	600	STD	70	1745	2165	2380	2750	3120	3435	3750	4120	4650	5280
										65	1915	2380	2610	3020	3425	3770	4120	4525	5105	5800
										50	2320	2880	3160	3655	4145	4565	4985	5480	6180	7020
										40	2605	3235	3555	4105	4660	5130	5605	6155	6945	7890
										25	3025	3760	4125	4770	5410	5960	6510	7150	8070	9165
										10	3450	4285	4700	5430	6160	6790	7415	8145	9190	10440
560/60 R 22.5	165 D/ 162 E	AG 16.00	16.00 ; 17.00 ; AG 20.00	543	1244	552	3767	600	STD	70	1555	1745	2170	2465	2850	3230	3530	3870	4250	4750
										65	1690	1900	2360	2685	3100	3515	3840	4210	4625	5150
										50	2050	2300	2860	3250	3755	4260	4650	5100	5600	6235
										40	2300	2580	3210	3650	4215	4785	5225	5725	6290	7005
										25	2670	3000	3730	4240	4900	5560	6070	6655	7310	8140
										10	3040	3415	4250	4830	5580	6330	6910	7580	8325	9270
560/60 R 22.5	161 D/ 158 E	AG 16.00	16.00 ; 17.00 ; AG 20.00	543	1244	549	3767	600	STD	70	1555	1745	2170	2465	2850	3230	3530	3870	4250	
										65	1690	1900	2360	2685	3100	3515	3840	4210	4625	5150
										50	2050	2300	2860	3250	3755	4260	4650	5100	5600	6235
										40	2300	2580	3210	3650	4215	4785	5225	5725	6290	7005
										25	2670	3000	3730	4240	4900	5560	6070	6655	7310	8140
										10	3040	3415	4250	4830	5580	6330	6910	7580	8325	9270
580/65 R 22.5	166 D/ 163 E	AG 18.00	AG 16.00 ; AG 17.00 ; AG 20.00	577	1326	572	4031	625	STD	70	1805	2050	2440	2880	3295	3660	4095	4485	4875	
										65	1965	2230	2650	3130	3580	3975	4455	4880	5300	5800
										50	2375	2695	3210	3785	4335	4815	5390	5905	6415	7005
										40	2670	3030	3605	4255	4870	5410	6060	6635	7210	7890
										25	3100	3520	4190	4945	5655	6285	7035	7705	8375	9140
										10	3535	4010	4770	5630	6440	7155	8015	8780	9540	10440
600/50 R 22.5	159 D/ 156 E	AG 20.00	-	611	1172	516	3574	550	STD	70	1480	1680	2040	2360	2720	3080	3320	3680	4000	
										65	1620	1840	2235	2585	2975	3370	3635	4025	4375	4775
										50	1960	2225	2705	3125	3605	4080	4395	4875	5295	5795
										40	2205	2500	3035	3515	4050	4585	4940	5475	5950	6475
										25	2560	2905	3530	4080	4705	5325	5740	6365	6915	7475
										10	2915	3310	4020	4650	5355	6065	6540	7245	7875	8575
650/50 R 22.5	163 D/ 160 E	AG 20.00	-	645	1222	535	3715	575	STD	70	1645	1845	2295	2610	3015	3420	3735	4095	4500	
										65	1780	2000	2490	2830	3270	3705	4050	4440	4875	5300
										50	2155	2420	3010	3425	3955	4485	4900	5370	5900	6430
										40	2425	2720	3385	3850	4445	5040	5505	6035	6630	7180
										25	2815	3160	3930	4470	5165	5860	6400	7015	7705	8375
										10	3205	3600	4480	5090	5880	6670	7285	7990	8775	9540
710/35 R 22.5	157 D/ 154 E	AG 24.00	-	712	1070	482	3254	525	STD	70	1370	1540	1915	2175	2515	2850	3115	3415	3750	
										65	1510	1695	2105	2395	2765	3135	3425	3755	4125	4500
										50	1825	2050	2550	2900	3350	3800	4150	4550	4995	5440
										40	2050	2305	2865	3255	3760	4265	4660	5110	5610	6110
										30	2275	2555	3180	3615	4175	4735	5175	5670	6230	6790
										25	2380	2675	3330	3785	4370	4960	5415	5935	6520	7110
10	2715	3045	3790	4310	4975	5645	6165	6760	7425	8090										

Technologies



Block Pattern



High Speed



Reinforced Bead



Steel Belted



VF Technology

Performance



Durability



Fuel Economy



Road Oriented



Self-Cleaning

STD: Standard



RIDEMAX FL 693 M

Ø 22.5"	Tire size	LI/SS	RIM		S.W. (mm)	O.D. (mm)	SLR (mm)	RC (mm)	SRI (index)	Version	Load capacity (kg/tire)									
			Rec.	Alt.							km/h - bar	1.0	1.2	1.6	2.0	2.4	2.8	3.2	3.6	4.0
710/45 R 22.5	165 D	AG 24.00	-	706	1212	542	3658	575	STD	70	1715	1925	2390	2720	3140	3565	3890	4265	4685	
										65	1880	2115	2630	2990	3455	3915	4275	4690	5150	
										50	2280	2560	3180	3620	4180	4740	5180	5675	6235	
										40	2560	2875	3575	4065	4695	5325	5815	6375	7005	
										30	2840	3190	3970	4515	5215	5915	6460	7080	7780	
										25	2975	3340	4155	4725	5455	6190	6760	7410	8140	
										10	3385	3805	4730	5380	6215	7050	7695	8440	9270	

Ø 26.5"	Tire size	LI/SS	RIM Rec.	RIM Alt.	S.W. (mm)	O.D. (mm)	SLR (mm)	RC (mm)	SRI (index)	Version	Load capacity (kg/tire)									
											km/h - bar	1.0	1.2	1.6	2.0	2.4	2.8	3.2	3.6	4.0
65	1910	2165	2630	3040	3505	3970	4275	4740	5150											
50	2310	2620	3180	3680	4240	4805	5180	5740	6235											
40	2595	2945	3575	4135	4765	5395	5815	6445	7005											
25	3015	3420	4155	4805	5540	6270	6760	7490	8140											
10	3435	3895	4730	5470	6305	7140	7695	8530	9270											

Tire size	LI/SS	RIM Rec.	RIM Alt.	S.W. (mm)	O.D. (mm)	SLR (mm)	RC (mm)	SRI (index)	Version	Load capacity (kg/tire)											
										km/h - bar	1.0	1.2	1.6	2.0	2.4	2.8	3.2	3.6	4.0	5.0	6.0
50	2740	3270	3980	4595	5305	6010	6450	7160	7865	8305	8835										
40	3080	3675	4470	5165	5960	6755	7250	8045	8840	9335	9930										
30	3420	4080	4965	5735	6615	7500	8050	8935	9815	10365	11025										
25	3580	4270	5195	6000	6925	7845	8425	9345	10270	10845	11535										
10	4075	4865	5915	6835	7885	8940	9595	10645	11695	12355	13140										

Tire size	LI/SS	RIM Rec.	RIM Alt.	S.W. (mm)	O.D. (mm)	SLR (mm)	RC (mm)	SRI (index)	Version	Load capacity (kg/tire)									
										km/h - bar	1.0	1.2	1.6	2.0	2.4	2.8	3.2	3.6	4.0
65	2150	2440	2960	3425	3945	4470	4815	5340	5800										
50	2600	2950	3585	4145	4775	5410	5830	6460	7020										
40	2920	3315	4025	4660	5370	6080	6500	7260	7890										
25	3395	3850	4675	5410	6235	7060	7610	8435	9165										
10	3865	4385	5325	6160	7100	8040	8670	9605	10440										

Tire size	LI/SS	RIM Rec.	RIM Alt.	S.W. (mm)	O.D. (mm)	SLR (mm)	RC (mm)	SRI (index)	Version	Load capacity (kg/tire)											
										km/h - bar	1.0	1.2	1.6	2.0	2.4	2.8	3.2	3.6	4.0	5.0	6.0
50	2815	3360	4085	4720	5445	6175	6625	7355	8080	8535	9075										
40	3165	3775	4590	5305	6120	6940	7450	8265	9080	9590	10200										
30	3515	4195	5100	5890	6795	7705	8270	9175	10080	10650	11325										
25	3675	4385	5335	6165	7110	8060	8655	9600	10550	11140	11850										
10	4185	4995	6075	7020	8100	9180	9855	10935	12015	12690	13500										

Tire size	LI/SS	RIM Rec.	RIM Alt.	S.W. (mm)	O.D. (mm)	SLR (mm)	RC (mm)	SRI (index)	Version	Load capacity (kg/tire)									
										km/h - bar	1.0	1.2	1.6	2.0	2.4	2.8	3.2	3.6	4.0
65	2220	2520	3060	3540	4080	4620	4980	5520	6000										
50	2690	3050	3705	4285	4940	5595	6030	6680	7260										
40	3025	3430	4165	4815	5550	6285	6775	7510	8160										
25	3510	3985	4835	5595	6450	7300	7870	8725	9480										
10	4000	4540	5510	6375	7345	8320	8965	9940	10800										

STD: Standard - HD: Heavy Duty

Technologies



Block Pattern



High Speed



Reinforced Bead



Steel Belted



VF Technology

Performance



Durability



Fuel Economy



Road Oriented



Self-Cleaning



FLOTATION

RIDEMAX FL 693 M

Ø 26.5"	Tire size	LI/SS	RIM		S.W. (mm)	O.D. (mm)	SLR (mm)	RC (mm)	SRI (index)	Version	Load capacity (kg/tire)										
			Rec.	Alt.							km/h - bar										
											1.0	1.2	1.6	2.0	2.4	2.8	3.2	3.6	4.0	5.0	6.0
710/50 R 26.5	179 D	AG 24.00	AG 20.00	727	1383	606	4217	650	HD	70	1765	2260	2825	3175	3670	4165	4590	5010	5505	6210	7055
										65	1940	2480	3100	3490	4030	4575	5040	5505	6045	6820	7750
										50	2345	3005	3755	4225	4880	5535	6100	6660	7320	8255	9380
										40	2635	3375	4220	4745	5485	6220	6855	7485	8225	9280	10540
										30	2930	3750	4685	5270	6090	6910	7610	8315	9130	10305	11705
										25	3065	3920	4900	5515	6370	7225	7960	8695	9555	10780	12245
										10	3490	4465	5580	6280	7255	8235	9070	9905	10885	12280	13950
Ø 30.5"	600/60 R 30.5	169 D	AG 20.00	AG 18.00	605	1495	681	4495	725	STD	70	1930	2165	2695	3065	3540	4015	4385	4805	5280	
											65	2120	2380	2960	3365	3890	4410	4815	5280	5800	
											50	2565	2880	3585	4075	4705	5340	5830	6390	7020	
											40	2880	3235	4025	4580	5290	6000	6550	7180	7890	
											30	3200	3595	4470	5085	5870	6660	7275	7975	8760	
											25	3350	3760	4675	5320	6145	6970	7610	8345	9165	
											10	3815	4285	5325	6060	6995	7935	8670	9505	10440	
600/60 R 30.5	173 D	AG 20.00	AG 18.00	605	1495	681	4495	725	STD	70	2045	2250	2725	3020	3490	3965	4380	4795	5265	5620	5915
										65	2245	2470	2990	3315	3835	4355	4810	5265	5785	6175	6500
										50	2715	2990	3620	4015	4645	5270	5825	6375	7000	7475	7865
										40	3050	3360	4070	4510	5220	5925	6545	7165	7870	8400	8840
										30	3390	3730	4515	5010	5795	6580	7265	7955	8740	9325	9815
										25	3545	3905	4725	5240	6060	6885	7600	8320	9145	9760	10270
										10	4040	4450	5385	5970	6905	7840	8660	9480	10415	11115	11700
650/65 R 30.5	176 D	AG 20.00	-	645	1623	734	4939	775	STD	70	2070	2395	2720	3300	3815	4400	4980	5370	5950	6465	
										65	2275	2630	2985	3625	4190	4830	5470	5895	6535	7100	
										50	2755	3185	3610	4385	5075	5845	6620	7135	7910	8595	
										40	3095	3580	4060	4930	5700	6570	7440	8020	8890	9660	
										25	3595	4155	4715	5725	6620	7630	8640	9315	10325	11220	
										10	4090	4730	5370	6520	7545	8695	9845	10610	11760	12780	
										710/50 R 30.5	173 D	AG 24.00	AG 20.00	727	1485	676	4533	700	STD	70	2220
65	2405	2730	3315	3835	4420	5005	5395	5980	6500												
50	2915	3305	4015	4645	5350	6060	6530	7240	7865												
40	3275	3715	4510	5220	6015	6810	7340	8135	8840												
25	3805	4315	5240	6060	6985	7910	8525	9450	10270												
10	4330	4915	5970	6905	7960	9010	9715	10765	11700												
750/60 R 30.5	181 D	AG 24.00	-	754	1675	728	5092	800	STD											70	2780
										65	3055	3465	4210	4870	5610	6355	6850	7590	8250		
										50	3700	4195	5095	5895	6790	7690	8290	9190	9985		
										40	4155	4715	5725	6620	7630	8640	9315	10325	11220		
										25	4825	5475	6650	7695	8865	10040	10820	11995	13035		
										10	5500	6240	7575	8765	10100	11435	12330	13665	14850		
										850/50 R 30.5	182 D	AG 28.00	-	862	1625	719	4925	725	STD	70	2865
65	3145	3570	4335	5015	5780	6545	7055	7820	8500												
50	3810	4320	5250	6070	6995	7920	8540	9465	10285												
40	4280	4860	5900	6825	7865	8905	9595	10640	11560												
25	4975	5645	6850	7925	9135	10345	11150	12360	13430												
10	5665	6430	7805	9030	10405	11785	12700	14080	15300												

Technologies



Block Pattern



High Speed



Reinforced Bead



Steel Belted



VF Technology

Performance



Durability



Fuel Economy



Road Oriented



Self-Cleaning

STD: Standard - HD: Heavy Duty

FL 630 SUPER

FL 630 SUPER is a flotation tire suitable for field and road applications with trailers, tankers and spreaders. Its resistant structure provides excellent traction and perfect grip even in bends and when maneuvering, while a reinforced bead and steel belts ensure enhanced durability.



Ø 22.5"	Tire size	LI/SS	RIM		S.W. (mm)	O.D. (mm)	SLR (mm)	RC (mm)	SRI (index)	Version	Load capacity (kg/tire)											
			Rec.	Alt.							km/h - bar											
											1.0	1.2	1.6	2.0	2.4	2.8	3.2	3.6	4.0	5.0		
560/60 R 22.5	165 D	AG 16.00	17.00 ; 20.00	543	1244	549	3785	600	STD	70	1555	1745	2170	2465	2850	3230	3530	3870	4250	4750		
										65	1690	1900	2360	2685	3100	3515	3840	4210	4625	5150		
										50	2050	2300	2860	3250	3755	4260	4650	5100	5600	6235		
										40	2300	2580	3210	3650	4215	4785	5225	5725	6290	7005		
										25	2670	3000	3730	4240	4900	5560	6070	6655	7310	8140		
										10	3040	3415	4250	4830	5580	6330	6910	7580	8325	9270		
560/60 R 22.5	161 D	AG 16.00	17.00 ; 20.00	543	1244	549	3785	600	STD	70	1360	1575	1785	2125	2510	2870	3190	3570	3910	4250		
										65	1480	1715	1945	2315	2730	3125	3470	3885	4255	4625		
										50	1795	2075	2355	2800	3305	3780	4200	4705	5155	5600		
										40	2015	2330	2645	3145	3715	4250	4720	5285	5790	6290		
										25	2340	2710	3075	3655	4315	4935	5485	6145	6730	7310		
										10	2665	3085	3500	4165	5915	5620	6245	6995	7660	8325		
580/65 R 22.5	166 D	AG 18.00	AG 16.00 ; AG 17.00 ; AG 20.00	577	1326	594	4058	625	STD	70	1560	1805	2050	2440	2880	3295	3660	4095	4485	4875		
										65	1700	1965	2230	2650	3130	3580	3975	4455	4880	5300		
										50	2055	2375	2695	3210	3785	4335	4815	5390	5905	6415		
										40	2310	2670	3030	3605	4255	4870	5410	6060	6635	7210		
										25	2680	3100	3520	4190	4945	5655	6285	7035	7705	8375		
										10	3055	3535	4010	4770	5630	6440	7155	8015	8780	9540		
580/65 R 22.5	174 D	AG 18.00	AG 16.00 ; AG 17.00 ; AG 20.00	582	1236	594	4058	625	STD	65	1955	2440	2745	3175	3600	3965	4335	4760	5065	5370	5735	6100
										50	2145	2680	3015	3485	3955	4355	4760	5230	5565	5900	6300	6700
										40	2600	3245	3650	4220	4785	5275	5760	6330	6735	7140	7625	8110
										30	2920	3650	4105	4740	5380	5925	6475	7110	7570	8025	8570	9115
										25	3390	4240	4770	5510	6250	6885	7520	8265	8790	9320	9955	10590
										10	3860	4825	5430	6275	7120	7840	8565	9410	10010	10615	11340	12060
600/50 R 22.5	159 D	AG 20.00	-	611	1170	518	3533	550	STD	70	1455	1635	2035	2315	2670	3030	3310	3630	3985			
										65	1600	1795	2235	2540	2935	3325	3635	3985	4375			
										50	1935	2175	2705	3075	3550	4025	4395	4820	5295			
										40	2175	2440	3035	3455	3990	4525	4940	5415	5950			
										25	2525	2840	3530	4015	4635	5260	5740	6295	6915			
										10	2875	3230	4020	4570	5280	5985	6540	7170	7875			
600/55 R 22.5	162 D	AG 20.00	-	595	1232	560	3757	575	STD	70	1580	1775	2210	2510	2900	3290	3590	3940	4325			
										65	1735	1950	2425	2755	3185	3610	3945	4325	4750			
										50	2100	2360	2935	3335	3855	4370	4775	5235	5750			
										40	2360	2650	3295	3750	4330	4910	5365	5880	6460			
										25	2740	3080	3830	4355	5030	5705	6230	6830	7505			
										10	3125	3510	4365	4960	5730	6500	7100	7785	8550			

Technologies



Performance



STD: Standard



FL 630 SUPER

∅ 26.5"	Tire size	LI/SS	RIM		S.W. (mm)	O.D. (mm)	SLR (mm)	RC (mm)	SRI (index)	Version	Load capacity (kg/tire)											
			Rec.	Alt.							km/h - bar											
											0.8	1.0	1.2	1.6	2.0	2.4	2.8	3.2	3.6	4.0		
600/55 R 26.5	165 D	AG 20.00	-	611	1333	606	4078	625	STD	65	1505	1740	1970	2395	2770	3190	3615	3895	4315	4690		
										50	1650	1910	2165	2630	3040	3505	3970	4275	4740	5150		
										40	2000	2310	2620	3180	3680	4240	4805	5180	5740	6235		
										30	2245	2595	2945	3575	4135	4765	5395	5815	6445	7005		
										25	2605	3015	3420	4155	4805	5540	6270	6760	7490	8140		
										10	2970	3435	3895	4730	5470	6305	7140	7695	8530	9270		
600/55 R 26.5	177 D	AG 20.00	-	611	1333	604	4104	625	HD	65	1825	2265	2705	3285	3800	4380	4965	5330	5915	6500	6865	7300
										50	2210	2740	3270	3980	4595	5305	6010	6450	7160	7865	8305	8835
										40	2485	3080	3675	4470	5165	5960	6755	7250	8045	8840	9335	9930
										30	2760	3420	4080	4965	5735	6615	7500	8050	8935	9815	10365	11025
										25	2885	3580	4270	5195	6000	6925	7845	8425	9345	10270	10845	11535
										10	3285	4075	4865	5915	6835	7885	8940	9595	10645	11695	12355	13140
650/55 R 26.5	169 D	AG 20.00	-	645	1389	627	4258	650	STD	70	1690	1955	2220	2695	3120	3595	4070	4385	4860	5280		
										65	1860	2150	2440	2960	3425	3945	4470	4815	5340	5800		
										50	2250	2600	2950	3585	4145	4775	5410	5830	6460	7020		
										40	2525	2920	3315	4025	4660	5370	6080	6550	7260	7890		
										25	2935	3395	3850	4675	5410	6235	7060	7610	8435	9165		
										10	3345	3865	4385	5385	6160	7100	8040	8670	9605	10440		
650/55 R 26.5	178 D	AG 20.00	-	645	1389	628	4292	650	HD	65	1875	2325	2775	3375	3900	4500	5100	5475	6075	6675	7050	7500
										50	2270	2815	3360	4085	4720	5445	6175	6625	7355	8080	8535	9075
										40	2550	3165	3775	4590	5305	6120	6940	7450	8265	9080	9590	10200
										30	2835	3515	4195	5100	5890	6795	7705	8270	9175	10080	10650	11325
										25	2965	3675	4385	5335	6165	7110	8060	8655	9600	10550	11140	11850
										10	3375	4185	4995	6075	7020	8100	9180	9855	10935	12015	12690	13500
650/65 R 26.5	174 D	AG 20.00	-	645	1519	684	4653	725	STD	70	1955	2260	2565	3115	3600	4150	4700	5065	5615	6100		
										65	2145	2480	2815	3420	3955	4560	5160	5565	6165	6700		
										50	2600	3005	3410	4140	4785	5515	6245	6735	7465	8110		
										40	2920	3375	3830	4650	5380	6200	7020	7570	8390	9115		
										25	3390	3920	4450	5405	6250	7205	8155	8790	9745	10590		
										10	3860	4465	5070	6155	7120	8205	9290	10010	11100	12060		
710/50 R 26.5	170 D	AG 24.00	AG 20.00	727	1383	626	4237	650	STD	70	1745	2020	2290	2780	3220	3710	4200	4525	5015	5450		
										65	1920	2220	2520	3060	3540	4080	4620	4980	5520	6000		
										50	2325	2690	3050	3705	4285	4940	5595	6030	6680	7260		
										40	2615	3025	3430	4165	4815	5550	6285	6775	7510	8160		
										25	3035	3510	3985	4835	5595	6450	7300	7870	8725	9480		
										10	3460	4000	4540	5510	6375	7345	8320	8965	9940	10800		
750/45 R 26.5	170 D	AG 24.00	-	754	1349	606	4147	650	STD	70	1750	1995	2240	2785	3170	3660	4150	4535	4970	5460		
										65	1920	2190	2460	3060	3480	4020	4560	4980	5460	6000		
										50	2325	2655	2980	3705	4215	4865	5520	6030	6610	7260		
										40	2615	2985	3350	4165	4735	5470	6205	6775	7430	8160		
										25	3035	3465	3890	4835	5500	6355	7205	7870	8630	9480		
										10	3460	3945	4430	5510	6265	7240	8210	8965	9830	10800		

Technologies



High Speed



Reinforced Bead



Steel Belted

Performance



Durability



Excellent flotation



Field Protection



Self-Cleaning



Traction

STD: Standard - HD: Heavy Duty





FLOTATION

FL 630 SUPER

Ø 26.5"	Tire size	LI/SS	RIM		S.W. (mm)	O.D. (mm)	SLR (mm)	RC (mm)	SRI (index)	Version	Load capacity (kg/tire)										
			Rec.	Alt.							km/h - bar	0.8	1.0	1.2	1.6	2.0	2.4	2.8	3.2	3.6	4.0
750/60 R 26.5	180 D	AG 24.00	-	754	1574	694	4800	725	STD	70	2340	2705	3070	3725	4310	4965	5625	6060	6720	7300	
										65	2560	2960	3360	4080	4720	5440	6160	6640	7360	8000	
										50	3100	3585	4070	4940	5715	6585	7455	8035	8910	9680	
										40	3485	4030	4570	5550	6420	7400	8380	9035	10010	10880	
										25	4045	4680	5310	6450	7460	8600	9735	10495	11630	12640	
										10	4610	5330	6050	7345	8500	9795	11090	11955	13250	14400	

Ø 30.5"	Tire size	LI/SS	RIM Rec.	RIM Alt.	S.W. (mm)	O.D. (mm)	SLR (mm)	RC (mm)	SRI (index)	Version	Load capacity (kg/tire)										
											km/h - bar	0.8	1.0	1.2	1.6	2.0	2.4	2.8	3.2	3.6	4.0
65	2275	2630	2985	3625	4190	4830	5470	5895	6535	7100											
50	2755	3185	3610	4385	5075	5845	6620	7135	7910	8595											
40	3095	3580	4060	4930	5700	6570	7440	8020	8890	9660											
25	3595	4155	4715	5725	6620	7630	8640	9315	10325	11220											
10	4090	4730	5370	6520	7545	8695	9845	10610	11760	12780											

Tire size	LI/SS	RIM Rec.	RIM Alt.	S.W. (mm)	O.D. (mm)	SLR (mm)	RC (mm)	SRI (index)	Version	Load capacity (kg/tire)										
										km/h - bar	0.8	1.0	1.2	1.6	2.0	2.4	2.8	3.2	3.6	4.0
65	2640	3055	3465	4210	4870	5610	6355	6850	7590	8250										
50	3200	3700	4195	5095	5895	6790	7690	8290	9190	9985										
40	3595	4155	4715	5725	6620	7630	8640	9315	10325	11220										
25	4175	4825	5475	6650	7695	8865	10040	10820	11995	13035										
10	4755	5500	6240	7575	8765	10100	11435	12330	13665	14850										

Tire size	LI/SS	RIM Rec.	RIM Alt.	S.W. (mm)	O.D. (mm)	SLR (mm)	RC (mm)	SRI (index)	Version	Load capacity (kg/tire)								
										km/h - bar	1.2	1.6	2.0	2.4	2.8	3.2	3.6	4.0
65	3485	4335	4930	5695	6460	7055	7735	8500										
50	4220	5250	5970	6895	7820	8540	9360	10285										
40	4740	5900	6705	7750	8790	9595	10520	11560										
25	5510	6850	7790	9000	10210	11150	12225	13430										
10	6275	7805	8875	10255	11630	12700	13925	15300										

Technologies



Performance



STD: Standard





FLOTATION

Radial



FL 630 ULTRA

FL 630 ULTRA is suitable for trailers, tankers and spreaders. Thanks to its reinforced bead and the particular tread design, it is the ideal tire for multipurpose use on any kind of land or on the road. FL 630 ULTRA stands for extraordinarily reduced soil compaction.

Ø 22.5"	Tire size	LI/SS	RIM		S.W. (mm)	O.D. (mm)	SLR (mm)	RC (mm)	SRI (index)	Version	Load capacity (kg/tire)										
			Rec.	Alt.							km/h - bar	0.8	1.0	1.2	1.6	2.0	2.4	2.8	3.2	3.6	4.0
500/60 R 22.5	155 D/166 A8	AG 16.00	15.00 ; 16.00 ; 17.00	503	1172	521	3592	550	STD	70	1130	1310	1485	1780	2085	2385	2670	2970	3250	3530	
										65	1240	1435	1630	1950	2290	2610	2930	3255	3565	3875	
										50	1505	1740	1970	2345	2770	3160	3540	3940	4315	4690	
										40	1700	1965	2230	2680	3110	3560	3990	4440	4880	5300	
										25	1960	2270	2575	3080	3615	4110	4630	5130	5635	6125	
										10	2235	2585	2930	3500	4100	4700	5250	5850	6420	6975	
560/45 R 22.5	152 D/163 A8	AG 16.00	-	543	1076	490	3290	525	STD	70	1040	1185	1330	1650	1880	2170	2460	2690	2945	3235	
										65	1140	1300	1460	1815	2060	2380	2700	2950	3235	3550	
										50	1380	1575	1765	2195	2495	2885	3270	3570	3915	4300	
										40	1560	1780	2000	2490	2830	3270	3705	4050	4440	4875	
										30	1720	1960	2200	2740	3115	3595	4080	4455	4885	5365	
										25	1800	2055	2305	2865	3255	3760	4265	4660	5110	5610	
560/60 R 22.5	161 D/172 A8	AG 16.00	16.00 ; 17.00 ; AG 20.00	543	1244	535	3760	600	STD	70	1350	1540	1730	2150	2445	2825	3200	3495	3835	4210	
										65	1480	1690	1900	2360	2685	3100	3515	3840	4210	4625	
										50	1795	2050	2300	2860	3250	3755	4260	4650	5100	5600	
										40	2020	2305	2585	3215	3655	4225	4790	5230	5735	6300	
										30	2240	2555	2865	3565	4055	4680	5310	5800	6360	6985	
										25	2340	2670	3000	3730	4240	4900	5560	6070	6655	7310	
600/50 R 22.5	159 D/170 A8	AG 20.00	-	611	1172	518	3533	550	STD	70	1280	1480	1675	2020	2355	2680	3020	3330	3670	3985	
										65	1400	1620	1840	2220	2585	2950	3310	3660	4025	4375	
										50	1695	1960	2225	2700	3125	3575	4000	4420	4875	5295	
										40	1920	2220	2520	3040	3540	4050	4555	5020	5520	6000	
										25	2215	2560	2905	3510	4080	4675	5210	5800	6365	6915	
										10	2520	2915	3310	4000	4650	5325	5940	6600	7245	7875	
710/40 R 22.5	161 D/172 A8	AG 24.00	-	727	1140	514	3490	550	STD	70	1350	1540	1730	2150	2445	2825	3200	3495	3835	4210	
										65	1480	1690	1900	2360	2685	3100	3515	3840	4210	4625	
										50	1795	2050	2300	2860	3250	3755	4260	4650	5100	5600	
										40	2020	2305	2585	3215	3655	4225	4790	5230	5735	6300	
										30	2240	2555	2865	3565	4055	4680	5310	5800	6360	6985	
										25	2340	2670	3000	3730	4240	4900	5560	6070	6655	7310	
10	2665	3040	3415	4250	4830	5580	6330	6910	7580	8325											

STD: Standard

Technologies



Reinforced Bead

Performance



Reduced Soil Compaction





FLOTATION

FL 630 ULTRA

Ø 26.5"	Tire size	LI/SS	RIM		S.W. (mm)	O.D. (mm)	SLR (mm)	RC (mm)	SRI (index)	Version	Load capacity (kg/tire)									
			Rec.	Alt.							km/h - bar									
											0.8	1.0	1.2	1.6	2.0	2.4	2.8	3.2	3.6	4.0
600/55 R 26.5	165 D/ 176 A8	AG 20.00	-	611	1333	579	4070	625	STD	65	1650	1910	2165	2630	3040	3505	3970	4275	4740	5150
										50	2000	2310	2620	3180	3680	4240	4805	5180	5740	6235
										40	2275	2630	2985	3625	4190	4830	5470	5895	6535	7100
										25	2605	3015	3420	4155	4805	5540	6270	6760	7490	8140
										10	2970	3435	3895	4730	5470	6305	7140	7695	8530	9270
650/55 R 26.5	169 D/ 180 A8	AG 20.00	-	645	1389	600	4207	650	STD	65	1860	2150	2440	2960	3425	3945	4470	4815	5340	5800
										50	2250	2600	2950	3585	4145	4775	5410	5830	6460	7020
										40	2560	2960	3360	4080	4720	5440	6160	6640	7360	8000
										25	2935	3395	3850	4675	5410	6235	7060	7610	8435	9165
										10	3345	3865	4385	5325	6160	7100	8040	8670	9605	10440
710/50 R 26.5	170 D/ 181 A8	AG 24.00	AG 20.00	727	1383	599	4208	650	STD	70	1750	1995	2240	2785	3170	3660	4150	4535	4970	5460
										65	1920	2190	2460	3060	3480	4020	4560	4980	5460	6000
										50	2325	2650	2980	3705	4210	4865	5520	6025	6610	7260
										40	2640	3015	3385	4210	4785	5530	6270	6850	7510	8250
										25	3035	3465	3890	4835	5500	6355	7205	7870	8630	9480
										10	3460	3945	4430	5510	6265	7240	8210	8965	9830	10800
800/45 R 26.5	174 D/ 184 A8	AG 28.00	AG 24.00	828	1393	618	4238	675	STD	70	1955	2230	2505	3115	3540	4090	4640	5065	5555	6100
										65	2145	2450	2750	3420	3890	4490	5095	5565	6100	6700
										50	2600	2965	3330	4140	4705	5435	6165	6735	7385	8110
										40	2880	3285	3690	4590	5220	6030	6840	7470	8190	9000
										30	3240	3695	4150	5165	5870	6785	7695	8400	9210	10120
										25	3390	3870	4345	5405	6145	7100	8050	8790	9640	10590
10	3860	4405	4945	6155	6995	8085	9170	10010	10975	12060										

STD: Standard

Technologies



Reinforced Bead

Performance



Reduced Soil Compaction





FLOTATION

Radial



FL 635

FL 635 is a radial flotation tire suitable for both road and field usage. The special block pattern has been designed for hay baler applications. FL 635 ensures a great pressure distribution on the ground across the footprint and drastically reduces soil compaction to preserve the value of the crops. The tire ensures great self-cleaning properties, durability and traction along with excellent speed features.

Ø 22.5"	Tire size	LI/SS	RIM		S.W. (mm)	O.D. (mm)	SLR (mm)	RC (mm)	SRI (index)	Version	Load capacity (kg/tire)										
			Rec.	Alt.							km/h - bar	0.8	1.0	1.2	1.6	2.0	2.4	2.8	3.2	3.6	4.0
620/40 R 22.5	154 D	AG 20.00	-	625	1068	470	3249	500	STD	70	1095	1250	1405	1745	1985	2290	2600	2835	3110	3415	
										65	1200	1370	1540	1915	2175	2515	2850	3115	3415	3750	
										50	1455	1660	1865	2320	2635	3045	3455	3770	4135	4540	
										40	1635	1865	2095	2605	2960	3420	3880	4235	4645	5100	
										25	1900	2165	2430	3025	3440	3970	4505	4920	5395	5925	
										10	2160	2465	2770	3445	3915	4525	5130	5605	6145	6750	
650/55 R 22.5	167 D	AG 20.00	-	645	1287	568	3901	600	STD	70	1590	1815	2035	2530	2880	3325	3770	4120	4515	4960	
										65	1745	1990	2235	2780	3165	3655	4145	4525	4960	5450	
										50	2115	2410	2705	3365	3830	4420	5015	5475	6005	6595	
										40	2375	2710	3045	3785	4305	4970	5640	6155	6750	7415	
										25	2760	3150	3535	4395	5000	5775	6550	7155	7840	8615	
										10	3140	3585	4025	5005	5690	6575	7460	8145	8930	9810	
710/40 R 22.5	161 D	AG 24.00	-	727	1140	510	3467	550	STD	70	1350	1540	1730	2150	2445	2825	3200	3495	3835	4210	
										65	1480	1690	1900	2360	2685	3100	3515	3840	4210	4625	
										50	1795	2050	2300	2860	3250	3755	4260	4650	5100	5600	
										40	2015	2300	2580	3210	3650	4215	4785	5225	5725	6290	
										30	2240	2555	2865	3565	4055	4680	5310	5800	6360	6985	
										25	2340	2670	3000	3730	4240	4900	5560	6070	6655	7310	
750/45 R 22.5	168 D	AG 24.00	-	754	1247	555	3810	600	STD	70	1635	1865	2095	2605	2960	3420	3880	4235	4645	5100	
										65	1795	2050	2300	2860	3250	3755	4260	4650	5100	5600	
										50	2170	2475	2780	3460	3935	4545	5155	5630	6170	6780	
										40	2440	2785	3125	3890	4420	5110	5795	6325	6935	7620	
										30	2710	3090	3470	4315	4910	5670	6430	7025	7700	8460	
										25	2835	3235	3630	4515	5135	5930	6730	7350	8055	8850	
10	3230	3685	4135	5145	5850	6755	7665	8370	9175	10080											

STD: Standard

Technologies



Performance





FLOTATION

Radial



FL 637

FL 637 is a radial flotation tire suitable for spreaders, trailers and tankers. The reinforced bead structure provides enhanced durability and higher load capacity. In addition to excellent flotation features leading to reduced soil compaction, this tire shows outstanding self-cleaning properties. The directional tread design ensures excellent traction and enabling speeds up to 70 km/h.

Ø 17"	Tire size	LI/SS	RIM		S.W. (mm)	O.D. (mm)	SLR (mm)	RC (mm)	SRI (index)	Version	Load capacity (kg/tire)																							
			Rec.	Alt.							km/h - bar	0.8	1.2	1.6	2.0	2.4	2.8	3.2	3.6	4.0	5.0													
520/50 R 17	151 D/ 148 E	16.00	-	516	952	414	2930	450	STD	70	915	1170	1420	1610	1860	2115	2335	2555	2805	3150														
										65	1005	1280	1555	1760	2040	2315	2555	2795	3075	3450														
										50	1215	1545	1880	2130	2465	2800	3090	3385	3720	4175														
										40	1365	1740	2115	2395	2775	3150	3475	3805	4180	4695														
										30	1515	1930	2345	2660	3075	3495	3860	4225	4640	5210														
										25	1585	2020	2455	2785	3220	3655	4040	4420	4855	5455														
										10	1805	2300	2795	3170	3665	4165	4600	5035	5530	6210														
Ø 22.5"	Tire size	LI/SS	Rec.	Alt.	S.W. (mm)	O.D. (mm)	SLR (mm)	RC (mm)	SRI (index)	Version	km/h - bar	0.8	1.2	1.6	2.0	2.4	2.8	3.2	3.6	4.0	4.5	5.0	5.5	6.0										
											560/45 R 22.5	160 D	AG 16.00	-	544	1076	501	3324	525	STD	70	990	1320	1650	1860	2145	2435	2685	2930	3220	3425	3630	3880	4125
																					65	1080	1440	1800	2025	2340	2655	2925	3195	3510	3735	3960	4230	4500
50	1310	1745	2180	2455	2835	3215	3540	3870	4250	4520											4795	5120	5445											
40	1470	1960	2450	2755	3185	3615	3980	4350	4775	5080											5390	5755	6120											
30	1635	2175	2720	3060	3535	4010	4420	4825	5305	5640											5980	6390	6795											
25	1710	2280	2845	3200	3700	4195	4625	5050	5550	5905											6260	6685	7110											
10	1945	2595	3240	3645	4215	4780	5265	5755	6320	6725											7130	7615	8100											

STD: Standard

Technologies



Reinforced Bead



High Speed

Performance



Durability



Reduced Soil Compaction



Self-Cleaning



Traction





FLOTATION

Radial



FL 639

FL 639 is a field-oriented flotation radial tire also suitable for spreading applications. Its wide footprint area ensures low soil compaction resulting in increased crop productivity. The reinforced bead and the sidewall protection contribute to an extended tire life-cycle. FL 639 ensures extraordinary traction along with great self-cleaning properties.

Ø 22.5"	Tire size	LI/SS	RIM		S.W. (mm)	O.D. (mm)	SLR (mm)	RC (mm)	SRI (index)	Version	Load capacity (kg/tire)												
			Rec.	Alt.							km/h - bar	0.8	1.0	1.2	1.6	2.0	2.4	2.8	3.2	3.6	4.0		
560/45 R 22.5	152 D/163 A8	AG 16.00	-	543	1076	484	3303	525	STD	70	1040	1200	1360	1620	1910	2170	2430	2720	2980	3235			
										65	1140	1320	1495	1790	2095	2380	2700	2960	3270	3550			
										50	1380	1595	1810	2150	2540	2900	3240	3615	3960	4300			
										40	1560	1805	2050	2450	2880	3270	3675	4090	4485	4875			
										25	1800	2080	2360	2820	3310	3775	4230	4700	5165	5610			
										10	2045	2365	2685	3200	3775	4300	4820	5350	5880	6390			
600/50 R 22.5	159 D/170 A8	AG 20.00	-	611	1172	521	3592	550	STD	70	1280	1480	1675	2020	2355	2680	3020	3330	3670	3985			
										65	1400	1620	1840	2220	2585	2950	3310	3660	4025	4375			
										50	1695	1960	2225	2700	3125	3575	4000	4420	4875	5295			
										40	1920	2220	2520	3040	3540	4050	4555	5020	5520	6000			
										25	2215	2560	2905	3510	4080	4675	5210	5800	6365	6915			
										10	2520	2915	3310	4000	4650	5325	5940	6600	7245	7875			
600/50 R 22.5	168 B/156 B	AG 20.00	-	611	1172	521	3592	550	STD	km/h - bar	0.8	1.0	1.2	1.4	1.6	1.8	2.0	2.2	2.4	2.6	2.8	3.0	3.2
										50 FR	2180	2490	2800	3125	3450	3725	4000	4310	4625	4885	5150	5375	5600
										50 DW	1550	1775	2000	2215	2430	2615	2800	3025	3250	3450	3650	3825	4000
710/40 R 22.5	170 B/158 B	AG 24.00	-	727	1140	503	3492	550	STD	km/h - bar	0.8	1.0	1.2	1.4	1.6	1.8	2.0	2.2	2.4	2.6	2.8	3.0	3.2
										50 FR	2300	2650	3000	3325	3650	3950	4250	4560	4875	5235	5600	5800	6000
										50 DW	1650	1885	2120	2345	2575	2785	3000	3225	3450	3725	4000	4125	4250
710/40 R 22.5	161 D/172 A8	AG 24.00	-	727	1140	503	3492	550	STD	70	1350	1560	1770	2150	2485	2865	3245	3495	3875	4210			
										65	1480	1715	1945	2360	2730	3145	3565	3840	4255	4625			
										50	1795	2075	2355	2860	3305	3810	4315	4650	5155	5600			
										40	2015	2330	2645	3210	3715	4280	4845	5225	5790	6290			
										25	2340	2710	3075	3730	4315	4975	5630	6070	6730	7310			
										10	2665	3085	3500	4250	4915	5665	6415	6910	7660	8325			
Ø 26.5"	850/40 R 26.5	173 D/184 A8	AG 28.00	-	860	1355	599	4122	650	STD	km/h - bar	0.8	1.2	1.6	2.0	2.4	2.8	3.2	3.6	4.0			
											70	1895	2430	3020	3435	3965	4500	4910	5385	5915			
											65	2080	2665	3315	3770	4355	4940	5395	5915	6500			
											50	2520	3225	4015	4565	5270	5980	6530	7160	7865			
											40	2880	3690	4590	5220	6030	6840	7470	8190	9000			
											30	3145	4025	5010	5695	6580	7460	8150	8935	9815			
											25	3290	4215	5240	5960	6885	7810	8525	9350	10270			
10	3745	4800	5970	6790	7840	8895	9715	10650	11700														

Technologies



Performance



STD: Standard



FLOTATION

Radial



FL 695

FL 695 has been specifically designed for trailers in construction and transport applications with a unique center block tread pattern. Thanks to its strong casing, FL 695 can carry heavy loads maintaining stability in all conditions and its deep tread ensures optimal self-cleaning during on and off-road applications. Multiple steel cord layers reinforce this pattern against punctures.

Ø 26.5"	Tire size	LI/SS	RIM		S.W. (mm)	O.D. (mm)	SLR (mm)	RC (mm)	SRI (index)	Version	Load capacity (kg/tire)													
			Rec.	Alt.							km/h - bar	0.8	1.2	1.6	2.0	2.4	2.8	3.2	3.6	4.0	4.5	5.0	5.5	6.0
600/55 R 26.5	173 D	AG20.00	-	591	1335	620	4090	625	SB	65	-	-	-	2925	3380	3835	4225	4615	5070	5395	5720	6110	6500	
										50	-	-	-	3540	4090	4645	5115	5585	6135	6530	6925	7395	7865	
										40	-	2920	3625	3980	4600	5220	5750	6280	6900	7340	7780	8310	8840	
										30	2455	3240	4025	4420	5105	5795	6380	6970	7660	8150	8640	9230	9815	
										25	2570	3390	4215	4625	5345	6060	6680	7295	8015	8525	9040	9655	10270	
										20	2685	3540	4400	4830	5580	6330	6975	7615	8370	8905	9440	10085	10725	
										10	2925	3865	4800	5265	6085	6905	7605	8310	9130	9715	10300	11000	11700	
650/55 R 26.5	178 D	AG20.00	AG22.00	630	1390	630	4242	675	SB	65	-	-	-	3375	3900	4425	4875	5325	5850	6225	6600	7050	7500	
										50	-	-	-	4085	4720	5355	5900	6445	7080	7535	7990	8535	9075	
										40	-	3370	4185	4590	5305	6020	6630	7245	7960	8470	8980	9590	10200	
										30	2835	3740	4645	5100	5890	6685	7365	8045	8835	9400	9970	10650	11325	
										25	2965	3915	4860	5335	6165	6995	7705	8415	9245	9840	10430	11140	11850	
										20	3095	4085	5075	5570	6435	7305	8045	8790	9655	10275	10890	11635	12375	
										10	3375	4455	5535	6075	7020	7965	8775	9585	10530	11205	11880	12690	13500	
Ø 30.5"	600/60 R 30.5	179 D	AG20.00	-	611	1495	693	4586	725	SB	65	-	-	-	3490	4030	4575	5040	5505	6045	6435	6820	7285	7750
											50	-	-	-	4225	4880	5535	6100	6660	7320	7790	8255	8820	9380
											40	-	3480	4325	4745	5485	6220	6855	7485	8225	8750	9280	9910	10540
											30	2930	3865	4800	5270	6090	6910	7610	8315	9130	9720	10305	11005	11705
											25	3065	4045	5025	5515	6370	7225	7960	8695	9555	10165	10780	11515	12245
											20	3200	4225	5245	5760	6655	7550	8315	9085	9980	10620	11260	12025	12790
											10	3490	4605	5720	6280	7255	8235	9070	9905	10885	11580	12280	13115	13950
710/50 R 30.5	177 D	AG24.00	AG20.00	700	1490	691	4553	700	SB	65	-	-	-	3725	4310	4895	5405	5915	6500	6935	7300			
										50	-	-	-	4510	5215	5920	6540	7160	7865	8395	8835			
										40	-	3675	4470	5065	5860	6655	7350	8045	8840	9435	9930			
										30	3200	4080	4965	5625	6505	7390	8160	8935	9815	10475	11025			
										25	3350	4270	5195	5885	6810	7730	8540	9345	10270	10960	11535			
										20	3495	4460	5425	6145	7110	8075	8915	9760	10725	11445	12045			
										10	3815	4865	5915	6705	7755	8805	9725	10645	11695	12485	13140			

SB: Steel Belted

Technologies



Strong Casing



Deep Tread

Performance



High Load Capacity



High Puncture Resistance



Self-Cleaning



Stability



FLOTATION

Radial



RIDEMAX FL 615

RIDEMAX FL 615 is a radial flotation tire suitable for trailers, tankers and spreaders. The steel belted structure offers high puncture resistant with increased durability and high load capacity. RIDEMAX FL 615 provides low rolling resistance on road with outstanding self-cleaning properties on the field. The rounded shoulder and wide footprint area ensure soil protection.

RIDEMAX
RADIAL TRANSPORT TIRES

Ø 32"	Tire size	LI/SS	RIM		S.W. (mm)	O.D. (mm)	SLR (mm)	RC (mm)	SRI (index)	Version	Load capacity (kg/tire)								
			Rec.	Alt.							km/h - bar	1.0	1.2	1.6	2.0	2.4	2.8	3.2	3.6
800/65 R 32	185 D	DW 27 B	-	830	1853	834	5624	875	SB	65	3980	4350	5275	5830	6755	7680	8420	9250	
										50	4815	5265	6385	7055	8175	9295	10190	11195	
										40	5410	5915	7175	7930	9185	10445	11450	12580	
										30	6010	6570	7965	8805	10200	11600	12715	13970	
										25	6285	6870	8335	9210	10670	12135	13300	14615	
										10	7160	7830	9495	10490	12155	13820	15155	16650	

SB: Steel Belted

Technologies



Steel Belted



Rounded Shoulder Technology

Performance



Reduced Soil Compaction



Self-Cleaning



High Load Capacity



Ideal for grassland



Low Rolling Resistance

FLOTATION 351

FLOTATION 351 is a bias flotation tire which best suits transport applications using trailers. Extra deep lugs provide outstanding traction and a longer tire life. FLOTATION 351 is the ideal tire on wet and moist surfaces ensuring high load capacity.



Ø 20"	Tire size	RIM		S.W. (mm)	O.D. (mm)	SLR (mm)	RC (mm)	Version	PR	Type	LI/SS	Load capacity (kg/tire)	
		Rec.	Alt.									km/h - bar	3.10
Ø 20"	42 X 25.00 - 20	20.50 HF	20.50 VF	605	1110	508	3302	STD	12	TL	135 B	50	2180
	42 X 25.00 - 20	20.50 HF	20.50 VF	605	1110	508	3302	STD	16	TL	139 B	km/h - bar	3.70
												50	2430
	48 X 25.00 - 20	20.50 HF	20.50 VF	630	1270	559	3785	STD	10	TL	144 B	km/h - bar	2.40
50												2800	
48 X 31.00 - 20	26.00 HF	26.00 VF	775	1283	559	3886	STD	12	TL	148 B	km/h - bar	2.70	
											50	3150	
Ø 25"	66 X 43.00 - 25	36.0 TH	-	1020	1750	782	5213	STD	10	TL	160 B	km/h - bar	1.70
	66 X 43.00 - 25	36.0 TH	-	1020	1750	782	5213	STD	16	TL	170 B	50	4500
												km/h - bar	2.80
50	6000												
66 X 43.00 - 25	36.0 TH	-	1020	1750	782	5213	STD	6	TL	150 B	km/h - bar	1.0	
											50	3350	

Performance



Durability



High Load Capacity



Traction

STD: Standard



FLOTATION

Bias



FLOTATION 558

FLOTATION 558 is a cross-ply flotation tire suitable for hay harvesters/balers, tankers and trailers both on and off the road. It is particularly recommended whenever traction is essential for good soil tillage in addition to high load capacity.

Ø 22.5"	Tire size	RIM		S.W. (mm)	O.D. (mm)	SLR (mm)	RC (mm)	Version	PR	Type	LI/SS Drive Wheel	LI/SS Free Rolling	Load capacity (kg/tire)			
		Rec.	Alt.										km/h - bar			
													4.60	4.80	5.00	
400/55 - 22.5	AG 11.75	12.25 ; 13.00 ; AG 13.00	405	1020	445	3084	STD	20	TL	144 A8/ 140 B	156 A8/ 152 B	10 FR	5335	5465	5600	
												20 FR	4800	4920	5040	
												30 FR	4265	4375	4480	
												40 FR	3810	3905	4000	
												50 FR	3430	3515	3550	
												10 DW	3730	3830	3920	
												20 DW	3360	3445	3530	
												30 DW	2985	3065	3135	
												40 DW	2665	2735	2800	
												50 DW	2400	2460	2500	
400/55 - 22.5	AG 11.75	12.25 ; 13.00 ; AG 13.00	405	1020	445	3084	STD	14	TL	138 A8/ 134 B	150 A8/ 146 B	10 FR	4285	4450	4690	
												20 FR	3855	4005	4220	
												30 FR	3425	3560	3750	
												40 FR	3060	3180	3350	
												50 FR	2755	2860	3000	
												10 DW	3015	3135	3305	
												20 DW	2715	2820	2975	
												30 DW	2415	2510	2645	
												40 DW	2155	2240	2360	
												50 DW	1940	2015	2120	
400/55 - 22.5	AG 11.75	12.25 ; 13.00 ; AG 13.00	405	1020	445	3084	STD	16	TL	140 A8/ 136 B	152 A8/ 148 B	10 FR	4745	4825	4970	
												20 FR	4270	4340	4475	
												30 FR	3795	3860	3975	
												40 FR	3390	3445	3550	
												50 FR	3050	3100	3150	
												10 DW	3345	3395	3500	
												20 DW	3010	3055	3150	
												30 DW	2675	2715	2800	
												40 DW	2390	2425	2500	
												50 DW	2150	2185	2240	

STD: Standard

Performance



Durability



High Load Capacity



Traction





FLOTATION 558

Ø 22.5"	Tire size	RIM		S.W. (mm)	O.D. (mm)	SLR (mm)	RC (mm)	Version	PR	Type	LI/SS Drive Wheel	LI/SS Free Rolling	Load capacity (kg/tire)			
		Rec.	Alt.										km/h - bar			
													3.70	3.80	4.00	
400/55 - 22.5	AG 11.75	12.25 ; 13.00 ; AG 13.00	405	1020	445	3084	AB HD	16	TL	140 A8/ 136 B	152 A8/ 148 B	10 FR	4745	4825	4970	
												20 FR	4270	4340	4475	
												30 FR	3795	3860	3975	
												40 FR	3390	3445	3550	
												50 FR	3050	3100	3150	
												10 DW	3345	3395	3500	
												20 DW	3010	3055	3150	
												30 DW	2675	2715	2800	
												40 DW	2390	2425	2500	
												50 DW	2150	2185	2240	
500/45 - 22.5	AG 16.00	-	500	1045	471	3167	STD	20	TL	146 A8/ 142 B	158 A8/ 154 B	10 FR	5795	5875	5950	
												20 FR	5215	5285	5355	
												30 FR	4635	4700	4760	
												40 FR	4140	4195	4250	
												50 FR	3725	3775	3750	
												10 DW	4090	4145	4200	
												20 DW	3680	3730	3780	
												30 DW	3270	3315	3360	
												40 DW	2920	2960	3000	
												50 DW	2630	2665	2650	
500/45 - 22.5	AG 16.00	-	500	1045	471	3167	STD	12	TL	136 A8/ 132 B	148 A8/ 144 B	10 FR	4020	4215	4410	
												20 FR	3615	3795	3970	
												30 FR	3215	3370	3530	
												40 FR	2870	3010	3150	
												50 FR	2585	2710	2800	
												10 DW	2855	2995	3135	
												20 DW	2570	2695	2820	
												30 DW	2285	2395	2510	
												40 DW	2040	2140	2240	
												50 DW	1835	1925	2000	
500/45 - 22.5	AG 16.00	-	500	1045	471	3167	STD	16	TL	142 A8/ 138 B	154 A8/ 150 B	10 FR	4900	5075	5250	
												20 FR	4410	4570	4725	
												30 FR	3920	4060	4200	
												40 FR	3500	3625	3750	
												50 FR	3150	3265	3350	
												10 DW	3465	3590	3710	
												20 DW	3120	3230	3340	
												30 DW	2770	2875	2970	
												40 DW	2475	2565	2650	
												50 DW	2230	2310	2360	

STD: Standard - AB HD: Aramid Belted HD

Performance



Durability



High Load Capacity



Traction





FLOTATION

FLOTATION 558

∅ 22.5"	Tire size	RIM		S.W. (mm)	O.D. (mm)	SLR (mm)	RC (mm)	Version	PR	Type	LI/SS Drive Wheel	LI/SS Free Rolling	Load capacity (kg/tire)			
		Rec.	Alt.										3.20	3.40	3.60	
	500/45 - 22.5	AG 16.00	-	500	1045	471	3167	AB HD	16	TL	142 A8/ 138 B	154 A8/ 150 B	10 FR	4900	5075	5250
													20 FR	4410	4570	4725
													30 FR	3920	4060	4200
													40 FR	3500	3625	3750
													50 FR	3150	3265	3350
													10 DW	3465	3590	3710
													20 DW	3120	3230	3340
													30 DW	2770	2875	2970
													40 DW	2475	2565	2650
													50 DW	2230	2310	2360

Performance



Durability



High Load Capacity



Traction

AB HD: Aramid Belted HD





FLOTATION

Bias



FLOTATION 647

FLOTATION 647 is an implement tire that features best traction on soft soil and grassland. In addition to excellent self-cleaning properties, the specially designed tread pattern provides a wide contact area, which ensures optimized ground pressure and excellent performance on soft soil.

Ø 15.3"	Tire size	RIM		S.W. (mm)	O.D. (mm)	SLR (mm)	RC (mm)	Version	PR	Type	LI/SS Drive Wheel	LI/SS Free Rolling	Load capacity (kg/tire)	
		Rec.	Alt.										km/h - bar	
	260/75 - 15.3	9.00	-	275	785	363	2380	STD	-	TL	119 A8	131 A8	5.50	
													40 FR	1950
													40 DW	1360
													km/h - bar	3.30
Ø 17"	520/50 - 17	AG 16.00	-	516	965	426	2907	STD	-	TL	147 B	159 B	50 FR	4375
													50 DW	3075
													km/h - bar	3.50
Ø 18"	425/70 - 18	13.00	-	435	1065	-	-	STD	-	TL	143 B	155 B	50 FR	3875
													50 DW	2725

Performance



Self-Cleaning



Traction

STD: Standard



FLOTATION 648

FLOTATION 648 is particularly suitable for field and road transport as well as for spreading operations. Some sizes are designed for hay harvesters/balers. The special tread design allows for carrying very heavy loads at low pressure, guaranteeing at the same time reduced soil compaction and preventing damage to crops.



Ø 17"	Tire size	RIM		S.W. (mm)	O.D. (mm)	SLR (mm)	RC (mm)	Version	PR	Type	LI/SS Drive Wheel	LI/SS Free Rolling	Load capacity (kg/tire)			
		Rec.	Alt.										km/h - bar			
													1.50	1.70	2.00	
500/50 - 17	AG 16.00	-	510	945	416	2750	STD	10	TL	128 A8/ 124 B	140 A8/ 136 B	10 FR	2960	3185	3500	
												20 FR	2665	2865	3150	
												30 FR	2370	2550	2800	
												40 FR	2115	2275	2500	
												50 FR	1905	2050	2240	
												10 DW	2130	2290	2520	
												20 DW	1915	2060	2270	
												30 DW	1700	1830	2015	
												40 DW	1520	1635	1800	
												50 DW	1370	1470	1600	
500/50 - 17	AG 16.00	-	510	945	416	2750	STD	14	TL	137 A8/ 133 B	149 A8/ 145 B	10 FR	3950	4160	4550	
												20 FR	3555	3740	4095	
												30 FR	3160	3325	3640	
												40 FR	2820	2970	3250	
												50 FR	2540	2675	2900	
												10 DW	2795	2940	3220	
												20 DW	2515	2645	2900	
												30 DW	2235	2350	2575	
												40 DW	1995	2100	2300	
												50 DW	1795	1890	2060	
500/50 - 17	AG 16.00	-	510	945	416	2750	STD	16	TL	139 A8/ 135 B	152 A8/ 148 B	10 FR	4790	4880	4970	
												20 FR	4310	4390	4475	
												30 FR	3830	3905	3975	
												40 FR	3420	3485	3550	
												50 FR	3080	3135	3150	
												10 DW	3275	3340	3400	
												20 DW	2950	3005	3060	
												30 DW	2620	2670	2720	
												40 DW	2340	2385	2430	
												50 DW	2105	2145	2180	

STD: Standard

Technologies



Performance





FLOTATION 648

Ø 17"	Tire size	RIM		S.W. (mm)	O.D. (mm)	SLR (mm)	RC (mm)	Version	PR	Type	LI/SS Drive Wheel	LI/SS Free Rolling	Load capacity (kg/tire)			
		Rec.	Alt.										km/h - bar	3.80	3.90	4.00
500/50 - 17	AG 16.00	-	510	945	416	2750	STD	18	TL	145 A8/141 B	157 A8/154 B	10 FR	5605	5690	5775	
												20 FR	5045	5120	5200	
												30 FR	4485	4555	4620	
												40 FR	4005	4065	4125	
												50 FR	3605	3660	3750	
												10 DW	3940	3995	4060	
												20 DW	3545	3595	3655	
												30 DW	3155	3200	3250	
												40 DW	2815	2855	2900	
												50 DW	2535	2570	2575	

Ø 20"	Tire size	RIM	S.W. (mm)	O.D. (mm)	SLR (mm)	RC (mm)	Version	PR	Type	LI/SS Drive Wheel	LI/SS Free Rolling	Load capacity (kg/tire)			
												km/h - bar	2.00	2.20	2.40
500/55 - 20	16.00	-	508	1058	458	3153	STD	12	TL	138 A8/134 B	150 A8/146 B	10 FR	4215	4460	4690
												20 FR	3795	4015	4220
												30 FR	3370	3565	3750
												40 FR	3010	3185	3350
												50 FR	2710	2865	3000
												10 DW	2970	3145	3305
												20 DW	2670	2830	2975
												30 DW	2375	2515	2645
												40 DW	2120	2245	2360
												50 DW	1910	2020	2120

Ø 22.5"	Tire size	RIM	S.W. (mm)	O.D. (mm)	SLR (mm)	RC (mm)	Version	PR	Type	LI/SS Drive Wheel	LI/SS Free Rolling	Load capacity (kg/tire)				
												km/h - bar	2.00	3.00	4.00	5.00
350/65 - 22.5	AG 11.75	-	358	1030	451	3069	STD	18	TL	139 A8/135 B	151 A8/147 B	10 FR	2830	3585	4240	4830
												20 FR	2545	3225	3820	4345
												30 FR	2260	2865	3395	3865
												40 FR	2020	2560	3030	3450
												50 FR	1820	2305	2725	3075
												10 DW	1990	2520	2990	3400
												20 DW	1790	2270	2690	3060
												30 DW	1590	2015	2390	2720
												40 DW	1420	1800	2135	2430
												50 DW	1280	1620	1920	2180

Ø 22.5"	Tire size	RIM	S.W. (mm)	O.D. (mm)	SLR (mm)	RC (mm)	Version	PR	Type	LI/SS Drive Wheel	LI/SS Free Rolling	Load capacity (kg/tire)			
												km/h - bar	1.50	2.50	3.50
385/65 - 22.5 (400/60 - 22.5)	AG 11.75	-	400	1070	475	3233	STD	16	TL	144 A8/140 B	156 A8/152 B	10 FR	3410	4600	5600
												20 FR	3070	4140	5040
												30 FR	2725	3680	4480
												40 FR	2435	3285	4000
												50 FR	2190	2955	3550
												10 DW	2385	3220	3920
												20 DW	2150	2900	3530
												30 DW	1910	2575	3135
												40 DW	1705	2300	2800
												50 DW	1535	2070	2500

STD: Standard

Technologies



Performance





FLOTATION 648

Ø 22.5"	Tire size	RIM		S.W. (mm)	O.D. (mm)	SLR (mm)	RC (mm)	Version	PR	Type	LI/SS Drive Wheel	LI/SS Free Rolling	Load capacity (kg/tire)		
		Rec.	Alt.										km/h - bar		
													3.80	4.00	4.30
385/65 - 22.5 (400/60 - 22.5)	AG 11.75	-	400	1070	475	3233	STD	18	TL	148 A8/ 144 B	160 A8/ 156 B	10 FR	5860	6040	6300
												20 FR	5275	5435	5670
												30 FR	4685	4835	5040
												40 FR	4185	4315	4500
												50 FR	3765	3885	4000
												10 DW	4100	4230	4410
												20 DW	3690	3805	3970
												30 DW	3280	3380	3530
												40 DW	2930	3020	3150
												50 DW	2635	2720	2800
385/65 - 22.5 (400/60 - 22.5)	AG 11.75	-	400	1070	475	3233	STD	22	TL	155 A8/ 151 B	167 A8/ 163 B	10 FR	7170	7400	7630
												20 FR	6450	6660	6865
												30 FR	5735	5920	6105
												40 FR	5120	5285	5450
												50 FR	4610	4755	4875
												10 DW	5095	5265	5425
												20 DW	4585	4740	4885
												30 DW	4075	4210	4340
												40 DW	3640	3760	3875
												50 DW	3275	3385	3450
400/60 - 22.5 (385/65 - 22.5)	AG 11.75	-	400	1070	475	3233	STD	22	TL	155 A8/ 151 B	167 A8/ 163 B	10 FR	7170	7400	7630
												20 FR	6450	6660	6865
												30 FR	5735	5920	6105
												40 FR	5120	5285	5450
												50 FR	4610	4755	4875
												10 DW	5095	5265	5425
												20 DW	4585	4740	4885
												30 DW	4075	4210	4340
												40 DW	3640	3760	3875
												50 DW	3275	3385	3450
400/60 - 22.5 (385/65 - 22.5)	AG 11.75	-	400	1070	475	3233	STD	16	TL	144 A8/ 140 B	156 A8/ 152 B	10 FR	3410	4600	5600
												20 FR	3070	4140	5040
												30 FR	2725	3680	4480
												40 FR	2435	3285	4000
												50 FR	2190	2955	3550
												10 DW	2385	3220	3920
												20 DW	2150	2900	3530
												30 DW	1910	2575	3135
												40 DW	1705	2300	2800
												50 DW	1535	2070	2500

STD: Standard

Technologies



Performance





FLOTATION 648

Ø 22.5"	Tire size	RIM		S.W. (mm)	O.D. (mm)	SLR (mm)	RC (mm)	Version	PR	Type	LI/SS Drive Wheel	LI/SS Free Rolling	Load capacity (kg/tire)		
		Rec.	Alt.										km/h - bar		
													3.80	4.00	4.30
400/60 - 22.5 (385/65 - 22.5)	AG 11.75	-	400	1070	475	3233	STD	18	TL	148 A8/ 144 B	160 A8/ 156 B	10 FR	5860	6040	6300
												20 FR	5275	5435	5670
												30 FR	4685	4835	5040
												40 FR	4185	4315	4500
												50 FR	3765	3885	4000
												10 DW	4100	4230	4410
												20 DW	3690	3805	3970
												30 DW	3280	3380	3530
												40 DW	2930	3020	3150
												50 DW	2635	2720	2800
500/50 - 22.5	AG 16.00	-	500	1070	475	3200	STD	16	TL	146 A8/ 142 B	158 A8/ 155 B	10 FR	5475	5710	5950
												20 FR	4925	5140	5355
												30 FR	4380	4570	4760
												40 FR	3910	4080	4250
												50 FR	3520	3670	3875
												10 DW	3865	4030	4200
												20 DW	3480	3630	3780
												30 DW	3090	3225	3360
												40 DW	2760	2880	3000
												50 DW	2485	2590	2650
500/50 - 22.5	AG 16.00	-	500	1070	475	3200	STD	20	TL	151 A8/ 147 B	163 A8/ 159 B	10 FR	6400	6615	6825
												20 FR	5760	5955	6145
												30 FR	5120	5290	5460
												40 FR	4570	4725	4875
												50 FR	4115	4255	4375
												10 DW	4530	4685	4830
												20 DW	4075	4215	4345
												30 DW	3625	3745	3865
												40 DW	3235	3345	3450
												50 DW	2910	3010	3075
500/50 - 22.5	AG 16.00	-	500	1070	475	3200	STD	12	TL	140 A8/ 136 B	152 A8/ 148 B	10 FR	3970	4695	4970
												20 FR	3570	4225	4475
												30 FR	3175	3760	3975
												40 FR	2835	3355	3550
												50 FR	2550	3020	3150
												10 DW	2800	3310	3500
												20 DW	2520	2980	3150
												30 DW	2240	2650	2800
												40 DW	2000	2365	2500
												50 DW	1800	2130	2240

STD: Standard

Technologies



Heavy Duty

Performance



Durability



High Load Capacity



Reduced Soil Compaction



Traction





FLOTATION 648

Ø 22.5"	Tire size	RIM		S.W. (mm)	O.D. (mm)	SLR (mm)	RC (mm)	Version	PR	Type	LI/SS Drive Wheel	LI/SS Free Rolling	Load capacity (kg/tire)		
		Rec.	Alt.												
													km/h - bar	3.40	3.50
500/60 - 22.5	AG 16.00	15.00 ; 17.00	500	1170	510	3489	STD	18	TL	153 A8/ 149 B	165 A8/ 161 B	10 FR	6970	7090	7210
												20 FR	6275	6380	6940
												30 FR	5580	5675	5770
												40 FR	4980	5065	5150
												50 FR	4480	4560	4625
												10 DW	4940	5025	5110
												20 DW	4450	4525	4600
												30 DW	3955	4020	4090
												40 DW	3530	3590	3650
												50 DW	3175	3230	3250
500/60 - 22.5	AG 16.00	15.00 ; 17.00	500	1170	510	3489	STD	12	TL	145 A8/ 142 B	157 A8/ 154 B	10 FR	4390	5195	5775
												20 FR	3950	4675	5200
												30 FR	3510	4155	4620
												40 FR	3135	3710	4125
												50 FR	2820	3340	3750
												10 DW	3085	3645	4060
												20 DW	2780	3280	3655
												30 DW	2470	2920	3250
												40 DW	2205	2605	2900
												50 DW	1985	2345	2650
500/60 - 22.5	AG 16.00	15.00 ; 17.00	500	1170	510	3489	STD	16	TL	151 A8/ 148 B	163 A8/ 159 B	10 FR	6315	6575	6825
												20 FR	5685	5915	6145
												30 FR	5050	5260	5460
												40 FR	4510	4695	4875
												50 FR	4060	4225	4375
												10 DW	4465	4650	4830
												20 DW	4020	4185	4345
												30 DW	3575	3720	3865
												40 DW	3190	3320	3450
												50 DW	2870	2990	3150
550/45 - 22.5	AG 16.00	-	525	1070	488	3253	STD	20	TL	154 A8/ 150 B	166 A8/ 162 B	10 FR	6270	6860	7420
												20 FR	5645	6175	6680
												30 FR	5020	5490	5935
												40 FR	4480	4900	5300
												50 FR	4030	4410	4750
												10 DW	4440	4860	5250
												20 DW	3995	4370	4725
												30 DW	3550	3885	4200
												40 DW	3170	3470	3750
												50 DW	2855	3125	3350

STD: Standard

Technologies



Performance





FLOTATION 648

∅ 22.5"	Tire size	RIM		S.W. (mm)	O.D. (mm)	SLR (mm)	RC (mm)	Version	PR	Type	LI/SS Drive Wheel	LI/SS Free Rolling	Load capacity (kg/tire)			
		Rec.	Alt.										km/h - bar			
													2.40	2.60	2.80	3.00
550/45 - 22.5	AG 16.00	-	525	1070	488	3253	STD	16	TL	147 A8/ 144 B	159 A8/ 156 B	10 FR	5600	5865	6125	
												20 FR	5040	5280	5515	
												30 FR	4480	4695	4900	
												40 FR	4000	4190	4375	
												50 FR	3600	3770	4000	
												10 DW	3935	4125	4305	
												20 DW	3540	3710	3875	
												30 DW	3145	3300	3445	
												40 DW	2810	2945	3075	
												50 DW	2530	2650	2800	
550/60 - 22.5	AG 16.00	-	550	1240	540	3725	STD	12	TL	148 A8/ 144 B	160 A8/ 156 B	10 FR	5175	5755	6300	
												20 FR	4655	5180	5670	
												30 FR	4140	4605	5040	
												40 FR	3695	4110	4500	
												50 FR	3325	3700	4000	
												10 DW	3620	4030	4410	
												20 DW	3255	3630	3970	
												30 DW	2895	3225	3530	
												40 DW	2585	2880	3150	
												50 DW	2325	2590	2800	
550/60 - 22.5	AG 16.00	-	550	1240	540	3725	STD	18	TL	156 A8/ 152 B	169 A8/ 165 B	10 FR	7820	7975	8120	
												20 FR	7035	7175	7310	
												30 FR	6255	6380	6495	
												40 FR	5585	5695	5800	
												50 FR	5025	5125	5150	
												10 DW	5390	5495	5600	
												20 DW	4850	4945	5040	
												30 DW	4310	4395	4480	
												40 DW	3850	3925	4000	
												50 DW	3465	3535	3550	
550/60 - 22.5	AG 16.00	-	550	1240	540	3725	STD	20	TL	158 A8/ 154 B	171 A8/ 167 B	10 FR	8315	8465	8610	
												20 FR	7485	7615	7750	
												30 FR	6655	6770	6890	
												40 FR	5940	6045	6150	
												50 FR	5345	5440	5450	
												10 DW	5745	5850	5950	
												20 DW	5170	5265	5355	
												30 DW	4600	4680	4760	
												40 DW	4105	4180	4250	
												50 DW	3625	3685	3750	

STD: Standard

Technologies



Performance





FLOTATION 648

Ø 22.5"	Tire size	RIM		S.W. (mm)	O.D. (mm)	SLR (mm)	RC (mm)	Version	PR	Type	LI/SS Drive Wheel	LI/SS Free Rolling	Load capacity (kg/tire)			
		Rec.	Alt.										km/h - bar			
													3.30	3.40	3.50	
550/60 - 22.5	AG 16.00	-	550	1240	540	3725	DB	20	TL	158 A8/ 154 B	171 A8/ 167 B	10 FR	8315	8465	8610	
												20 FR	7485	7615	7750	
												30 FR	6655	6770	6890	
												40 FR	5940	6045	6150	
												50 FR	5345	5440	5450	
												10 DW	5745	5850	5950	
												20 DW	5170	5265	5355	
												30 DW	4600	4680	4760	
												40 DW	4105	4180	4250	
												50 DW	3625	3685	3750	
600/50 - 22.5	AG 20.00	-	611	1170	510	3501	STD	12	TL	147 A8/ 144 B	159 A8/ 156 B	10 FR	5175	5570	6125	
												20 FR	4655	5015	5515	
												30 FR	4140	4460	4900	
												40 FR	3695	3980	4375	
												50 FR	3325	3580	4000	
												10 DW	3640	3915	4305	
												20 DW	3275	3520	3875	
												30 DW	2910	3130	3445	
												40 DW	2600	2795	3075	
												50 DW	2340	2515	2800	
600/50 - 22.5	AG 20.00	-	611	1170	510	3501	STD	16	TL	153 A8/ 149 B	165 A8/ 161 B	10 FR	6540	6880	7210	
												20 FR	5885	6195	6490	
												30 FR	5230	5505	5770	
												40 FR	4670	4915	5150	
												50 FR	4205	4425	4625	
												10 DW	4635	4880	5110	
												20 DW	4170	4390	4600	
												30 DW	3705	3905	4090	
												40 DW	3310	3485	3650	
												50 DW	2980	3135	3250	
600/50 - 22.5	AG 20.00	-	611	1170	510	3501	STD	18	TL	155 A8/ 151 B	167 A8/ 163 B	10 FR	7315	7475	7630	
												20 FR	6585	6730	6865	
												30 FR	5850	5980	6105	
												40 FR	5225	5340	5450	
												50 FR	4705	4805	4875	
												10 DW	5200	5315	5425	
												20 DW	4680	4780	4885	
												30 DW	4160	4250	4340	
												40 DW	3715	3795	3875	
												50 DW	3345	3415	3450	

STD: Standard - DB: Dual Bead

Technologies



Heavy Duty

Performance



Durability



High Load Capacity



Reduced Soil Compaction



Traction





FLOTATION 648

Ø 22.5"	Tire size	RIM		S.W. (mm)	O.D. (mm)	SLR (mm)	RC (mm)	Version	PR	Type	LI/SS Drive Wheel	LI/SS Free Rolling	Load capacity (kg/tire)			
		Rec.	Alt.										km/h - bar			
													3.00	3.10	3.20	3.00
600/50 - 22.5	AG 20.00	-	611	1170	510	3501	DB	20	TL	156 A8/ 152 B	169 A8/ 165 B	10 FR	7820	7975	8120	
												20 FR	7035	7175	7310	
												30 FR	6255	6380	6495	
												40 FR	5585	5695	5800	
												50 FR	5025	5125	5150	
												10 DW	5390	5495	5600	
												20 DW	4850	4945	5040	
												30 DW	4310	4395	4480	
												40 DW	3850	3925	4000	
												50 DW	3465	3535	3550	
600/55 - 22.5	AG 20.00	-	600	1230	540	3716	STD	12	TL	151 A8/ 148 B	164 A8/ 160 B	10 FR	5915	6365	7000	
												20 FR	5325	5725	6300	
												30 FR	4730	5090	5600	
												40 FR	4225	4545	5000	
												50 FR	3805	4090	4500	
												10 DW	4080	4390	4830	
												20 DW	3675	3950	4345	
												30 DW	3265	3510	3865	
												40 DW	2915	3135	3450	
												50 DW	2625	2820	3150	
600/55 - 22.5	AG 20.00	-	600	1230	540	3716	STD	16	TL	156 A8/ 153 B	169 A8/ 166 B	10 FR	7365	7750	8120	
												20 FR	6630	6975	7310	
												30 FR	5890	6200	6495	
												40 FR	5260	5535	5800	
												50 FR	4735	4980	5300	
												10 DW	5080	5340	5600	
												20 DW	4575	4805	5040	
												30 DW	4065	4275	4480	
												40 DW	3630	3815	4000	
												50 DW	3265	3435	3650	
600/55 - 22.5	AG 20.00	-	600	1230	540	3716	DB	20	TL	160 A8/ 156 B	173 A8/ 169 B	10 FR	8765	8930	9100	
												20 FR	7890	8040	8190	
												30 FR	7010	7145	7280	
												40 FR	6260	6380	6500	
												50 FR	5635	5740	5800	
												10 DW	6070	6180	6300	
												20 DW	5460	5565	5670	
												30 DW	4855	4945	5040	
												40 DW	4335	4415	4500	
												50 DW	3900	3975	4000	

STD: Standard - DB: Dual Bead

Technologies



Performance





FLOTATION 648

Ø 22.5"	Tire size	RIM		S.W. (mm)	O.D. (mm)	SLR (mm)	RC (mm)	Version	PR	Type	LI/SS Drive Wheel	LI/SS Free Rolling	Load capacity (kg/tire)			
		Rec.	Alt.										km/h - bar			
													1.80	2.00	2.20	
700/40 - 22.5	AG 24.00	-	700	1170	510	3537	STD	16	TL	154 A8/150 B	166 A8/162 B	10 FR	6600	7020	7420	
												20 FR	5940	6320	6680	
												30 FR	5280	5615	5935	
												40 FR	4715	5015	5300	
												50 FR	4245	4515	4750	
												10 DW	4670	4965	5250	
												20 DW	4200	4465	4725	
												30 DW	3735	3970	4200	
												40 DW	3335	3545	3750	
												50 DW	3000	3190	3350	
700/40 - 22.5	AG 24.00	-	700	1170	510	3537	STD	12	TL	148 A8/144 B	160 A8/157 B	10 FR	5850	6085	6300	
												20 FR	5265	5475	5670	
												30 FR	4680	4865	5040	
												40 FR	4180	4345	4500	
												50 FR	3760	3910	4125	
												10 DW	4100	4255	4410	
												20 DW	3690	3830	3970	
												30 DW	3280	3405	3530	
												40 DW	2930	3040	3150	
												50 DW	2635	2735	2800	
700/40 - 22.5	AG 24.00	-	700	1170	510	3537	HD	18	TL	160 A8/156 B	173 A8/169 B	10 FR	8415	8765	9100	
												20 FR	7575	7890	8190	
												30 FR	6730	7010	7280	
												40 FR	6010	6260	6500	
												50 FR	5410	5635	5800	
												10 DW	5825	6070	6300	
												20 DW	5240	5460	5670	
												30 DW	4660	4855	5040	
												40 DW	4160	4335	4500	
												50 DW	3745	3900	4000	
700/50 - 22.5	24.00	-	700	1270	550	3775	STD	12	TL	156 A8/153 B	168 A8/164 B	10 FR	7050	7315	7840	
												20 FR	6345	6585	7055	
												30 FR	5640	5850	6270	
												40 FR	5035	5225	5600	
												50 FR	4530	4705	5000	
												10 DW	5035	5230	5600	
												20 DW	4530	4705	5040	
												30 DW	4025	4185	4480	
												40 DW	3595	3735	4000	
												50 DW	3235	3360	3650	

STD: Standard - HD: Heavy Duty

Technologies



Heavy Duty

Performance



Durability



High Load Capacity



Reduced Soil Compaction



Traction



Ø 22.5"	Tire size	RIM		S.W. (mm)	O.D. (mm)	SLR (mm)	RC (mm)	Version	PR	Type	LI/SS Drive Wheel	LI/SS Free Rolling	Load capacity (kg/tire)			
		Rec.	Alt.										km/h - bar			
													2.00	2.20	2.40	
700/50 - 22.5	24.00	-	700	1270	550	3775	STD	16	TL	162 A8/ 158 B	174 A8/ 170 B	10 FR	8430	8910	9380	
												20 FR	7585	8020	8440	
												30 FR	6740	7130	7505	
												40 FR	6020	6365	6700	
												50 FR	5420	5730	6000	
												10 DW	5980	6320	6650	
												20 DW	5380	5690	5985	
												30 DW	4780	5055	5320	
												40 DW	4270	4515	4750	
												50 DW	3845	4065	4250	
												700/50 - 22.5	24.00	-	700	1270
20 FR	7585	8020	8440													
30 FR	6740	7130	7505													
40 FR	6020	6365	6700													
50 FR	5420	5730	6000													
70 FR	4755	5030	5300													
10 DW	5980	6320	6650													
20 DW	5380	5690	5985													
30 DW	4780	5055	5320													
40 DW	4270	4515	4750													
50 DW	3845	4065	4250													
70 DW	3375	3565	3750													
Ø 26.5"	600/55 - 26.5	AG 20.00	-	611	1354	581	4017	STD	18	TL	160 A8/ 157 B	172 A6/ 169 B	10 FR	8455	8640	8820
													20 FR	7610	7775	7940
													30 FR	6765	6910	7055
													40 FR	6040	6170	6300
													50 FR	5435	5555	5800
													10 DW	6040	6175	6300
													20 DW	5435	5555	5670
													30 DW	4835	4940	5040
													40 DW	4315	4410	4500
													50 DW	3885	3970	4125
													600/55 - 26.5	AG 20.00	-	611
20 FR	5480	6100	6490													
30 FR	4870	5420	5770													
40 FR	4350	4840	5150													
50 FR	3915	4355	4625													
10 DW	4320	4800	5110													
20 DW	3885	4320	4600													
30 DW	3455	3840	4090													
40 DW	3085	3430	3650													
50 DW	2775	3085	3250													

STD: Standard - HS: High Speed

Technologies



Performance





FLOTATION 648

Ø 26.5"	Tire size	RIM		S.W. (mm)	O.D. (mm)	SLR (mm)	RC (mm)	Version	PR	Type	LI/SS Drive Wheel	LI/SS Free Rolling	Load capacity (kg/tire)		
		Rec.	Alt.										km/h - bar		
													2.20	2.40	2.60
600/55 - 26.5	AG 20.00	-	611	1354	581	4017	STD	16	TL	159 A8/ 156 B	170 A8/ 167 B	10 FR	7615	8015	8400
												20 FR	6855	7215	7560
												30 FR	6095	6410	6720
												40 FR	5440	5725	6000
												50 FR	4895	5155	5450
												10 DW	5560	5845	6125
												20 DW	5000	5260	5515
												30 DW	4445	4675	4900
												40 DW	3970	4175	4375
												50 DW	3575	3760	4000
700/50 - 26.5	24.00	-	700	1373	621	4099	STD	12	TL	157 A8/ 154 B	169 A8/ 165 B	10 FR	7300	7580	8120
												20 FR	6570	6825	7310
												30 FR	5840	6065	6495
												40 FR	5215	5415	5800
												50 FR	4695	4875	5150
												10 DW	5195	5390	5775
												20 DW	4675	4850	5200
												30 DW	4155	4310	4620
												40 DW	3710	3850	4125
												50 DW	3340	3465	3750
700/50 - 26.5	24.00	-	700	1373	621	4099	STD	16	TL	162 A8/ 158 B	174 A8/ 170 B	10 FR	8430	8910	9380
												20 FR	7585	8020	8440
												30 FR	6740	7130	7505
												40 FR	6020	6365	6700
												50 FR	5420	5730	6000
												10 DW	5980	6320	6650
												20 DW	5380	5690	5985
												30 DW	4780	5055	5320
												40 DW	4270	4515	4750
												50 DW	3845	4065	4250
800/45 - 26.5	AG 28.00	-	800	1393	631	4185	STD	12	TL	158 A8/ 155 B	170 A8/ 167 B	10 FR	7805	8105	8400
												20 FR	7025	7295	7560
												30 FR	6245	6485	6720
												40 FR	5575	5790	6000
												50 FR	5020	5210	5450
												10 DW	5530	5740	5950
												20 DW	4975	5165	5355
												30 DW	4425	4590	4760
												40 DW	3950	4100	4250
												50 DW	3555	3690	3875

STD: Standard

Technologies



Performance





FLOTATION 648

∅ 26.5"	Tire size	RIM		S.W. (mm)	O.D. (mm)	SLR (mm)	RC (mm)	Version	PR	Type	LI/SS Drive Wheel	LI/SS Free Rolling	Load capacity (kg/tire)															
		Rec.	Alt.										km/h - bar															
													2.60	2.70	2.80													
800/45 - 26.5	AG 28.00	-	800	1393	631	4185	STD	20	TL	170 A8/ 167 B	183 A8/ 180 B	10 FR	11730	11990	12250													
												20 FR	10560	10790	11025													
												30 FR	9385	9595	9800													
												40 FR	8380	8565	8750													
												50 FR	7540	7710	8000													
												10 DW	8045	8225	8400													
												20 DW	7240	7405	7560													
												30 DW	6435	6580	6720													
												40 DW	5745	5875	6000													
												50 DW	5170	5290	5450													
												800/45 - 26.5	AG 28.00	-	800	1393	631	4185	STD	16	TL	164 A8/ 160 B	177 A8/ 173 B	10 FR	9085	9665	10220	
																								20 FR	8175	8700	9200	
30 FR	7270	7735	8175																									
40 FR	6490	6905	7300																									
50 FR	5840	6215	6500																									
10 DW	6225	6620	7000																									
20 DW	5600	5960	6300																									
30 DW	4980	5300	5600																									
40 DW	4445	4730	5000																									
50 DW	4000	4225	4500																									
∅ 30.5"	650/65 - 30.5	AG 20.00	-	670	1660	710	4935	STD	12	TL	162 A8/ 158 B													174 A8/ 170 B	10 FR	8715	9050	9380
																									20 FR	7845	8145	8440
												30 FR	6970	7240	7505													
												40 FR	6225	6465	6700													
												50 FR	5605	5820	6000													
												10 DW	6180	6420	6650													
												20 DW	5565	5775	5985													
												30 DW	4945	5135	5320													
												40 DW	4415	4585	4750													
												50 DW	3975	4125	4250													
												650/65 - 30.5	AG 20.00	-	670	1660	710	4935	STD	16	TL	167 A8/ 163 B	179 A8/ 175 B		10 FR	9645	10260	10850
																									20 FR	8680	9235	9765
30 FR	7715	8210	8680																									
40 FR	6890	7330	7750																									
50 FR	6200	6595	6900																									
10 DW	6785	7215	7630																									
20 DW	6105	6495	6865																									
30 DW	5425	5775	6105																									
40 DW	4845	5155	5450																									
50 DW	4360	4640	4875																									

STD: Standard

Technologies



Performance





FLOTATION 648

∅ 30.5"	Tire size	RIM		S.W. (mm)	O.D. (mm)	SLR (mm)	RC (mm)	Version	PR	Type	LI/SS Drive Wheel	LI/SS Free Rolling	Load capacity (kg/tire)			
		Rec.	Alt.										km/h - bar			
													1.80	2.00	2.20	
650/65 - 30.5	AG 20.00	-	670	1660	710	4935	HD	16	TL	167 A8/ 163 B	179 A8/ 175 B	1.80				
												10 FR	9645	10260	10850	
												20 FR	8680	9235	9765	
												30 FR	7715	8210	8680	
												40 FR	6890	7330	7750	
												50 FR	6200	6595	6900	
												10 DW	6785	7215	7630	
												20 DW	6105	6495	6865	
												30 DW	5425	5775	6105	
												40 DW	4845	5155	5450	
50 DW	4360	4640	4875	2.20												
650/65 - 30.5	AG 20.00	-	670	1660	710	4935	HD	18	TL	169 A8/ 165 B	181 A8/ 178 B	2.30				
												10 FR	10995	11275	11550	
												20 FR	9895	10150	10395	
												30 FR	8800	9020	9240	
												40 FR	7855	8055	8250	
												50 FR	7070	7250	7500	
												10 DW	7735	7930	8120	
												20 DW	6960	7140	7310	
												30 DW	6190	6345	6495	
												40 DW	5525	5665	5800	
50 DW	4975	5100	5150	2.50												
750/60 - 30.5	AG 24.00	-	754	1675	710	4935	STD	12	TL	164 A8/ 160 B	176 A8/ 172 B	1.50				
												10 FR	9240	9595	9940	
												20 FR	8315	8635	8945	
												30 FR	7390	7680	7950	
												40 FR	6600	6855	7100	
												50 FR	5940	6170	6300	
												10 DW	6505	6755	7000	
												20 DW	5855	6080	6300	
												30 DW	5200	5405	5600	
												40 DW	4645	4825	5000	
50 DW	4180	4345	4500	1.70												
750/60 - 30.5	AG 24.00	-	754	1675	710	4935	STD	16	TL	170 A8/ 167 B	182 A8/ 179 B	1.80				
												10 FR	10585	11255	11900	
												20 FR	9525	10130	10710	
												30 FR	8465	9005	9520	
												40 FR	7560	8040	8500	
												50 FR	6805	7235	7750	
												10 DW	7470	7945	8400	
												20 DW	6720	7150	7560	
												30 DW	5975	6355	6720	
												40 DW	5335	5675	6000	
50 DW	4800	5110	5450	2.20												

STD: Standard - HD: Heavy Duty

Technologies



Performance





FLOTATION 648

Ø 30.5"	Tire size	RIM		S.W. (mm)	O.D. (mm)	SLR (mm)	RC (mm)	Version	PR	Type	LI/SS Drive Wheel	LI/SS Free Rolling	Load capacity (kg/tire)			
		Rec.	Alt.										km/h - bar			
													1.10	1.30	1.50	1.80
850/50 - 30.5	AG 28.00	-	850	1650	710	4935	STD	12	TL	168 A8/ 164 B	180 A8/ 176 B	10 FR	9345	10305	11200	
												20 FR	8410	9275	10080	
												30 FR	7475	8245	8960	
												40 FR	6675	7360	8000	
												50 FR	6010	6625	7100	
												10 DW	6540	7210	7840	
												20 DW	5885	6490	7055	
												30 DW	5230	5770	6270	
												40 DW	4670	5150	5600	
												50 DW	4205	4635	5000	
850/50 - 30.5	AG 28.00	-	850	1650	710	4935	STD	16	TL	174 A8/ 170 B	186 A8/ 182 B	10 FR	11830	12580	13300	
												20 FR	10645	11320	11970	
												30 FR	9465	10065	10640	
												40 FR	8450	8985	9500	
												50 FR	7605	8085	8500	
												10 DW	8345	8870	9380	
												20 DW	7510	7980	8440	
												30 DW	6675	7095	7505	
												40 DW	5960	6335	6700	
												50 DW	5365	5700	6000	
850/50 - 30.5	AG 28.00	-	850	1650	710	4935	HD	16	TL	174 A8/ 170 B	186 A8/ 182 B	10 FR	11830	12580	13300	
												20 FR	10645	11320	11970	
												30 FR	9465	10065	10640	
												40 FR	8450	8985	9500	
												50 FR	7605	8085	8500	
												10 DW	8345	8870	9380	
												20 DW	7510	7980	8440	
												30 DW	6675	7095	7505	
												40 DW	5960	6335	6700	
												50 DW	5365	5700	6000	
850/50 - 30.5	AG 28.00	-	850	1650	710	4935	HD	18	TL	176 A8/ 173 B	189 A8/ 185 B	10 FR	13735	14075	14420	
												20 FR	12360	12670	12980	
												30 FR	10985	11260	11535	
												40 FR	9810	10055	10300	
												50 FR	8830	9050	9250	
												10 DW	9465	9700	9940	
												20 DW	8520	8730	8945	
												30 DW	7570	7760	7950	
												40 DW	6760	6930	7100	
												50 DW	6085	6235	6500	

STD: Standard - HD: Heavy Duty

Technologies



Performance





Bias

FLOTATION 648 T

FLOTATION 648 T is particularly suitable for hay harvesting as well as for field and road transport. The special tread design allows for carrying very heavy loads at low pressure and ensures outstanding self-cleaning properties. The tire also stands for excellent traction and durability.



Ø 22.5"	Tire size	RIM		S.W. (mm)	O.D. (mm)	SLR (mm)	RC (mm)	Version	PR	Type	LI/SS Drive Wheel	LI/SS Free Rolling	Load capacity (kg/tire)			
		Rec.	Alt.										km/h - bar			
													3.00	3.50	4.00	
550/45 - 22.5	AG 16.00	-	550	1070	475	3203	STD	20	TL	154 A8/ 150 B	166 A8/ 162 B	10 FR	6270	6860	7420	
												20 FR	5645	6175	6680	
												30 FR	5020	5490	5935	
												40 FR	4480	4900	5300	
												50 FR	4030	4410	4750	
												10 DW	4440	4860	5250	
												20 DW	3995	4370	4725	
												30 DW	3550	3885	4200	
												40 DW	3170	3470	3750	
												50 DW	2855	3125	3350	
550/45 - 22.5	AG 16.00	-	550	1070	475	3203	STD	16	TL	147 A8/ 144 B	159 A8/ 156 B	10 FR	5600	5865	6125	
												20 FR	5040	5280	5515	
												30 FR	4480	4695	4900	
												40 FR	4000	4190	4375	
												50 FR	3600	3770	4000	
												10 DW	3935	4125	4305	
												20 DW	3540	3710	3875	
												30 DW	3145	3300	3445	
												40 DW	2810	2945	3075	
												50 DW	2530	2650	2800	

STD: Standard

Performance



Durability



High Load Capacity



Traction



FLOTATION TR 675

FLOTATION TR 675 is best suited for field and road transport. It fits trailers and implement machinery. FLOTATION TR 675 has been engineered to provide outstanding traction, high load capacity and a longer tire life.



FLOTATION

Ø 22.5"	Tire size	RIM		S.W. (mm)	O.D. (mm)	SLR (mm)	RC (mm)	Version	PR	Type	LI/SS Drive Wheel	LI/SS Free Rolling	Load capacity (kg/tire)			
		Rec.	Alt.										km/h - bar			
													1.50	2.00	2.40	
500/60 - 22.5	AG 16.00	15.00; 17.00	515	1181	542	3604	STD	12	TL	145 A8/ 142 B	157 A8/ 154 B	10 FR	4390	5195	5775	
												20 FR	3950	4675	5200	
												30 FR	3510	4155	4620	
												40 FR	3135	3710	4125	
												50 FR	2820	3340	3750	
												10 DW	3085	3645	4060	
												20 DW	2780	3280	3655	
												30 DW	2470	2920	3250	
												40 DW	2205	2605	2900	
												50 DW	1985	2345	2650	
500/60 - 22.5	AG 16.00	15.00; 17.00	515	1181	542	3604	STD	16	TL	151 A8/ 148 B	163 A8/ 159 B	10 FR	6315	6575	6825	
												20 FR	5685	5915	6145	
												30 FR	5050	5260	5460	
												40 FR	4510	4695	4875	
												50 FR	4060	4225	4375	
												10 DW	4465	4650	4830	
												20 DW	4020	4185	4345	
												30 DW	3575	3720	3865	
												40 DW	3190	3320	3450	
												50 DW	2870	2990	3150	
500/60 - 22.5	AG 16.00	15.00; 17.00	515	1181	542	3604	DB	20	TL	155 A8/ 151 B	168 A8/ 164 B	10 FR	7425	7545	7840	
												20 FR	6685	6790	7055	
												30 FR	5940	6035	6270	
												40 FR	5305	5390	5600	
												50 FR	4775	4850	5000	
												10 DW	5255	5340	5425	
												20 DW	4730	4805	4885	
												30 DW	4205	4275	4340	
												40 DW	3755	3815	3875	
												50 DW	3380	3435	3450	

STD: Standard - DB: Dual Bead

Performance



Durability



High Load Capacity



Traction





FLOTATION TR 675

∅ 22.5"	Tire size	RIM		S.W. (mm)	O.D. (mm)	SLR (mm)	RC (mm)	Version	PR	Type	LI/SS Drive Wheel	LI/SS Free Rolling	Load capacity (kg/tire)			
		Rec.	Alt.										km/h - bar			
													3.00	3.50	4.00	
550/45 - 22.5	AG 16.00	-	543	1070	-	-	STD	20	TL	154 A8/ 150 B	166 A8/ 162 B	10 FR	6270	6860	7420	
												20 FR	5645	6175	6680	
												30 FR	5020	5490	5935	
												40 FR	4480	4900	5300	
												50 FR	4030	4410	4750	
												10 DW	4440	4860	5250	
												20 DW	3995	4370	4725	
												30 DW	3550	3885	4200	
												40 DW	3170	3470	3750	
												50 DW	2855	3125	3350	
550/60 - 22.5	AG 16.00	-	550	1260	547	3640	STD	12	TL	148 A8/ 144 B	160 A8/ 156 B	10 FR	5175	5755	6300	
												20 FR	4655	5180	5670	
												30 FR	4140	4605	5040	
												40 FR	3695	4110	4500	
												50 FR	3325	3700	4000	
												10 DW	3620	4030	4410	
												20 DW	3255	3630	3970	
												30 DW	2895	3225	3530	
												40 DW	2585	2880	3150	
												50 DW	2325	2590	2800	
550/60 - 22.5	AG 16.00	-	550	1260	547	3640	STD	16	TL	154 A8/ 150 B	167 A8/ 163 B	10 FR	6970	7310	7630	
												20 FR	6275	6575	6865	
												30 FR	5580	5845	6105	
												40 FR	4980	5220	5450	
												50 FR	4480	4700	4875	
												10 DW	4795	5025	5250	
												20 DW	4315	4525	4725	
												30 DW	3835	4020	4200	
												40 DW	3425	3590	3750	
												50 DW	3085	3230	3350	

STD: Standard

Performance



Durability



High Load Capacity



Traction

FLOTATION TR 678

FLOTATION TR 678 has been specially designed for trailers and agricultural implements both on- and off the road. This tire allows for carrying very heavy loads at low pressure ensuring reduced soil compaction at the same time. It provides excellent traction and outstanding self-cleaning properties.



FLOTATION

Ø 12"	Tire size	RIM		S.W. (mm)	O.D. (mm)	SLR (mm)	RC (mm)	Version	PR	Type	LI/SS Drive Wheel	LI/SS Free Rolling	Load capacity (kg/tire)	
		Rec.	Alt.										km/h - bar	
Ø 12"	320/60 - 12	10.50 I	-	328	689	327	2111	STD	-	TT	120 A8	132 A8	4.00	
													40 FR	2000
													40 DW	1400
Ø 15.5"	280/60 - 15.5	8.0	-	275	750	357	2250	STD	-	TL	115 A8		2.40	
													40	1215
	280/60 - 15.5	8.0	-	275	750	357	2250	STD	-	TL	128 A8		4.7	
													40	1800
													6.00	
													40	4500
Ø 22.5"	600/40 - 22.5	AG 20.00	-	615	1085	483	3264	DB	20	TL	157 A8	169 A8	4.10	
													40	5800
	600/40 - 22.5	AG 20.00	-	615	1085	483	3264	DB HD	20	TL	157 A8	169 A8	6.00	
													40	5800
	600/40 - 22.5	AG 20.00	-	615	1085	483	3264	IND	20	TL	157 A8	169 A8	4.10	
													40 FR	5800
													40 DW	4125
	650/45 - 22.5	AG 20.00	-	650	1150	502	3302	STD	20	TL	166 B		4.50	
													50	5300
	650/45 - 22.5	AG 20.00	-	650	1150	502	3302	STD	-	TL	160 D		4.00	
													65	4875
	650/45 - 22.5	AG 20.00	-	650	1150	502	3302	SB	20	TL	166 B		4.50	
50													5300	
710/40 - 22.5	AG 24.00	-	707	1165	-	-	ASB	-	TL	173 A8		6.0		
												40	6500	

Performance



Durability



High Load Capacity



Self-Cleaning



Traction

STD: Standard - DB: Dual Bead - DB HD: Dual Bead HD - IND: Industrial - SB: Steel Belted - ASB: Aramid Steel Belted



FLOTATION

Bias



FLOTATION RIB 774

FLOTATION RIB 774 is suitable in all free-rolling applications, hay harvesting applications and ideal for trailers. It has been designed to provide best handling comfort optimizing the timing of operations as well as high load capacity and a longer tire life.

Ø 22.5"	Tire size	RIM		S.W. (mm)	O.D. (mm)	SLR (mm)	RC (mm)	Version	PR	Type	LI/SS Drive Wheel	LI/SS Free Rolling	Load capacity (kg/tire)		
		Rec.	Alt.										km/h - bar		
													1.50	1.80	2.10
550/60 - 22.5	AG 16.00	-	550	1240	540	3725	STD	12	TL	-	160 A8/ 156 B	10 FR	5175	5755	6300
												20 FR	4655	5180	5670
												30 FR	4140	4605	5040
												40 FR	3695	4110	4500
												50 FR	3325	3700	4000
												km/h - bar	2.40	2.60	2.80
550/60 - 22.5	AG 16.00	-	550	1240	540	3725	STD	16	TL	-	167 A8/ 163 B	10 FR	6970	7310	7630
												20 FR	6275	6575	6865
												30 FR	5580	5845	6105
												40 FR	4980	5220	5450
												50 FR	4480	4700	4875
												km/h - bar	1.50	1.70	2.00
600/55 - 22.5	AG 20.00	-	600	1230	540	3716	STD	12	TL	-	164 A8/ 160 B	10 FR	5915	6365	7000
												20 FR	5325	5725	6300
												30 FR	4730	5090	5600
												40 FR	4225	4545	5000
												50 FR	3805	4090	4500
												km/h - bar	2.20	2.40	2.60
600/55 - 22.5	AG 20.00	-	600	1230	540	3716	STD	16	TL	-	169 A8/ 166 B	10 FR	7365	7750	8120
												20 FR	6630	6975	7310
												30 FR	5890	6200	6495
												40 FR	5260	5535	5800
												50 FR	4735	4980	5300
												km/h - bar	1.50	1.70	2.00

Performance



Durability



High Load Capacity

STD: Standard





FORESTRY





FORESTECH (LS-2)

FORESTECH is a BKT bias steel-belted tire, suitable for forestry applications with forwarders. It provides excellent traction even in heavy-duty service. The strong bead and shoulder area ensure high puncture resistance as well as a longer tire life-cycle. As a result, you can deal with the most difficult operating conditions in a forest without concern.

Ø 22.5"	Tire size	RIM		S.W. (mm)	O.D. (mm)	SLR (mm)	RC (mm)	Version	PR	Type	LI/SS	Load capacity (kg/tire)	
		Rec.	Alt.									km/h - bar	5.00
Ø 22.5"	710/40 - 22.5	AG 24.00	-	710	1165	550	3612	SB	20	TL	161 A8/ 165 A2	40	4625
												30	5000
												10	5150
												km/h - bar	5.00
Ø 26.5"	600/55 - 26.5	AG 20.00	-	610	1335	618	4032	SB	20	TL	165 A8/ 172 A2	40	5150
												30	5510
												10	6300
												km/h - bar	5.00
Ø 26.5"	710/45 - 26.5	AG 24.00	-	710	1340	620	4047	SB	20	TL	168 A8/ 175 A2	40	5600
												30	5990
												10	6900
												km/h - bar	5.00
Ø 26.5"	750/55 - 26.5	AG 24.00	-	755	1485	680	4467	SB	20	TL	177 A8/ 184 A2	40	7300
												30	7810
												10	9000
												km/h - bar	5.00

Technologies



Performance



SB: Steel Belted



FS 216 (LS-2)

FS 216 has a robust log design with optimum angle and wider width to enhance traction performance for loggers and skidders. It provides excellent cut and chip resistance under the most critical operating conditions and ensures maximum protection against possible damages at any time.

Ø 26"	Tire size	RIM		S.W. (mm)	O.D. (mm)	SLR (mm)	RC (mm)	Version	PR	Type	Load capacity (kg/tire)		
		Rec.	Alt.								km/h - bar	2.10	1.70
18.4 - 26	DW 16 A	-	467	1476	682	4433	SB	10	TT	km/h - bar	2.10	1.70	
										10	3600	-	
										30	-	2575	
23.1 - 26	DW 20 A ; DW 20 B	-	587	1615	726	4780	SB	20	TT	km/h - bar	3.20	3.00	
										10	6700	-	
										30	-	5150	
23.1 - 26	DW 20 A ; DW 20 B	-	587	1615	726	4780	SB	10	TT	km/h - bar	1.70	1.40	
										10	4540	-	
										30	-	3250	
23.1 - 26	DW 20 A ; DW 20 B	-	587	1615	726	4780	SB	14	TT	km/h - bar	2.40	2.10	
										10	5760	-	
										30	-	4125	
23.1 - 26	DW 20 A ; DW 20 B	-	587	1615	726	4780	SB	16	TL	km/h - bar	2.80	2.40	
										10	6300	-	
										30	-	4500	
23.1 - 26	DW 20 A ; DW 20 B	-	587	1615	726	4780	SB	12	TT	km/h - bar	2.10	1.70	
										10	5260	-	
										30	-	3750	
23.1 - 26	DW 20 A ; DW 20 B	-	587	1615	726	4780	SB	16	TT	km/h - bar	2.80	2.40	
										10	6300	-	
										30	-	4500	
28L - 26	DW 25 A ; DW 25 B	-	720	1660	742	4912	SB	18	TL	km/h - bar	2.60	2.2	
										10	6900	-	
										30	-	4875	

STD: Standard

Technologies



Reinforced Bead

Performance



Durability



High Load Capacity



High Puncture Resistance



Self-Cleaning



Traction

Ø 26"	Tire size	RIM		S.W. (mm)	O.D. (mm)	SLR (mm)	RC (mm)	Version	PR	Type	Load capacity (kg/tire)		
		Rec.	Alt.								km/h - bar	2.10	1.70
Ø 26"	28L - 26	DW 25 A ; DW 25 B	-	720	1660	742	4912	SB	14	TL	10	5940	-
											30	-	4250
	28L - 26	DW 25 A ; DW 25 B	-	720	1660	742	4912	SB	20	TL	km/h - bar	2.80	2.40
											10	7300	-
	28L - 26	DW 25 A ; DW 25 B	-	720	1660	742	4912	SB	26	TL	30	-	5150
											km/h - bar	4.00	3.40
28L - 26	DW 25 A ; DW 25 B	-	720	1660	742	4912	SB	26	TL	10	9200	-	
										30	-	6550	
Ø 30"	18.4 - 30	DW 16 A	-	467	1577	724	4736	SB	10	TT	km/h - bar	2.10	1.70
											10	3820	-
	18.4 - 30	DW 16 A	-	467	1577	724	4736	SB	14	TT	30	-	2725
											km/h - bar	2.80	2.40
	18.4 - 30	DW 16 A	-	467	1577	724	4736	SB	14	TT	10	4750	-
											30	-	3350
Ø 32"	24.5 - 32	DH 21	DH 21 B	622	1831	836	5456	SB	16	TL	km/h - bar	2.40	2.10
											10	7000	-
	24.5 - 32	DH 21	DH 21 B	622	1831	836	5456	SB	16	TL	30	-	5000
											km/h - bar	3.8	3.5
	30.5L - 32	DH 27	DH 27 B	775	1847	833	5466	SB	32	TL	10	11500	-
											30	-	8000
30.5L - 32	DH 27	DH 27 B	775	1847	833	5466	SB	16	TL	km/h - bar	2.10	1.70	
										10	7450	-	
30.5L - 32	DH 27	DH 27 B	775	1847	833	5466	SB	16	TL	30	-	5300	
										km/h - bar	2.40	2.10	
30.5L - 32	DH 27	DH 27 B	775	1847	833	5466	SB	20	TL	10	8400	-	
										30	-	6000	

SB: Steel Belted

Technologies

Reinforced Bead

Performance

Durability



High Load Capacity



High Puncture Resistance



Self-Cleaning



Traction

FS 216 (LS-2)

Ø 32"	Tire size	RIM		S.W. (mm)	O.D. (mm)	SLR (mm)	RC (mm)	Version	PR	Type	Load capacity (kg/tire)		
		Rec.	Alt.								km/h - bar	3.10	2.80
30.5L - 32	DH 27	DH 27 B	775	1847	833	5466	SB	26	TL	10	10000	-	
										30	-	7100	
										km/h - bar	1.70	2.10	
DH 35.5L - 32	DH 31	DH 31 H	907	2011	912	5992	STD	20	TL	10	-	10200	
										30	7300	-	
										km/h - bar	3.1	3.5	
DH 35.5L - 32	DH 31	DH 31 H	907	2011	912	5992	SB	30	TL	10	-	13950	
										30	10300	-	
										km/h - bar	2.10	2.40	
DH 35.5L - 32	DH 31	DH 31 H	907	2011	912	5992	SB	24	TL	10	-	11200	
										30	8000	-	
										km/h - bar	2.10	1.70	
Ø 34"	18.4 - 34	DW 16 A	-	467	1679	768	5042	SB	10	TT	10	4060	-
											30	-	2900
											km/h - bar	2.80	2.40
18.4 - 34	DW 16 A	-	467	1679	768	5042	SB	14	TL	10	4875	-	
										30	-	3550	
										km/h - bar	2.10	1.70	

SB: Steel Belted - STD: Standard

Technologies



Reinforced Bead

Performance



Durability



High Load Capacity



High Puncture Resistance



Self-Cleaning



Traction





FORESTRY



Bias



F 240 (LS-2)

F 240 is a forestry tire designed for logging applications. Its tread pattern provides excellent traction, self-cleaning properties in addition to good steering. The superior tread compound ensures extraordinary cut-and-wear resistance resulting in a longer service life. F 240 shows a large contact area for better stability.

Ø 15.5"	Tire size	RIM		S.W. (mm)	O.D. (mm)	SLR (mm)	RC (mm)	Version	PR	Type	Load capacity (kg/tire)	
		Rec.	Alt.								km/h - bar	
											3.50	
	18 - 15.5	AG 13.00	-	450	990	430	2930	STD	14	TT	30	4185
	400 - 15.5 (400 - 15.5)	AG 13.00	-	405	865	-	-	STD	12	TT	3.80	
											30	3150

STD: Standard

Performance

- Cut Resistance
- Durability
- Self-Cleaning
- Traction





FORESTRY

 Bias



TR 675 (LS-2)

TR 675 is a bias tire specially designed for forestry applications. Its robust lug design provides excellent traction and self-cleaning, while the strong casing structure allows to carry heavy loads and its steel belts protect the tire from punctures and damages. TR 675 features a cut-resistant tread compound providing excellent cut-and-chip resistance even on difficult terrains under extreme conditions.

Ø 28"	Tire size	RIM		S.W. (mm)	O.D. (mm)	SLR (mm)	RC (mm)	Version	PR	Type	LI/SS	Load capacity (kg/tire)	
		Rec.	Alt.									km/h - bar	
	540/65 - 28	W 16 L	W 18 L	530	1425	663	4440	SB	16	TL	155 A8/ 161 A2	40	3875

SB: Steel Belted

Technologies



Strong Casing



Steel Belted

Performance



Cut and Chip Resistance



High Load Capacity



Self-Cleaning



Traction

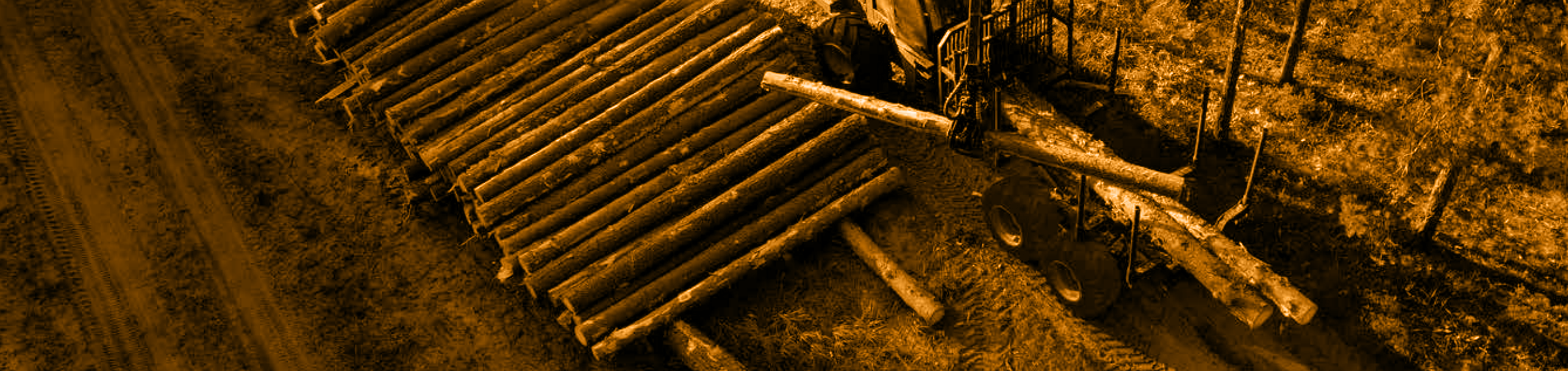



TR 678 (LS-2)

TR 678 has been specially designed for forestry applications. Its robust lug design provides excellent traction and self-cleaning. The strong casing structure stands for high load capacity whereas its steel belts protect the tire from punctures and damages. TR 678 features a cut-resistant tread compound providing excellent cut-and-chip resistance even on difficult terrains under extreme conditions.

Ø 26.5"	Tire size	RIM		S.W. (mm)	O.D. (mm)	SLR (mm)	RC (mm)	Version	PR	Type	LI/SS	Load capacity (kg/tire)	
		Rec.	Alt.									km/h - bar	
Ø 26.5"	600/55 - 26.5	AG 20.00	-	605	1350	-	-	SB	20	TL	172 A2 / 165 A8	5.50	
												40	5150
												10	6300
Ø 28.5"	780/50 - 28.5	AG 26.00	-	770	1515	-	-	SB	24	TL	190 A2 / 182 A8	6.00	
												40	8500
												10	10600
Ø 34"	600/65 - 34	DW 20 B	-	610	1644	758	4916	SB	16	TL	166 A2 / 162 A6	2.60	
												30	4750
												10	5300
	600/65 - 34	DW 20 B	-	610	1644	758	4916	SB	20	TL	170 A2 / 166 A6	3.20	
												30	5300
												10	6000
	600/65 - 34	DW 20 B	-	610	1644	758	4916	SB	14	TL	164 A2 / 160 A6	2.40	
												30	4500
												10	5000
	710/55 - 34	DW 24 B	-	700	1640	757	4890	SB	14	TL	168 A2 / 163 A6	2.40	
												30	4875
												10	5600
710/55 - 34	DW 24 B	-	700	1640	757	4890	SB	20	TL	173 A2 / 168 A6	3.20		
											30	5600	
											10	6500	

SB: Steel Belted

Technologies



Steel Belted

Performance



Cut and Chip Resistance



High Load Capacity



Self-Cleaning



Traction



FORESTLAND (LS-2)

FORESTLAND is BKT's latest and innovative agro-forestry pattern. This bias tire has been specifically designed for heavy-duty service in forestry applications but, it can also be employed in some agricultural operations such as landscaping and light mulching. FORESTLAND is a particularly robust tire thanks to its strong polyester casing. Moreover, the special cut-and-chip resistant tread compound along with the strong sidewall ensure a long tire life even under the harshest operating conditions. Whilst the open shoulder design provides excellent traction on loose soil, the particular tread pattern and its stiff and reinforced lugs stand for good grip in any soil along with top self-cleaning properties. In addition, the strong bead construction ensures a high level of stability in heavy-duty operations.

Ø 28"	Tire size	RIM		S.W. (mm)	O.D. (mm)	SLR (mm)	RC (mm)	Version	PR	Type	LI/SS	Load capacity (kg/tire)	
		Rec.	Alt.									km/h - bar	
14.9 - 28	W 13 W 12, W 11	W 13	W 12, W 11	378	1365	-	-	STD	14	TT	140 A8/ 137 B	3.00	
												40	2500
												50	2300
Ø 38"	18.4 - 38	W 16 L	W 15 L	467	1750	813	5384	STD	14	TT	155 A8/ 152 B	2.60	
												40	3875
												50	3550

STD: Standard

Technologies



Heavy Duty



Strong Casing



Special Compound

Performance



Cut and Chip Resistance



High Puncture Resistance



Durability



Traction



Self-Cleaning



Stability



FORESTMAX

FORESTMAX is BKT's new radial tire for tractors, which has been mainly developed for forestry applications, but can also be employed for some specific farming operations such as soil milling and stone breaking. Its multi-ply polyester casing and the reinforced sidewall are designed to withstand the harsh forestry operating conditions. In addition, the cut-and-chip-resistant tread compound and the steel-belted structure significantly minimize the risk of punctures in the woodland. The tire features a robust open shoulder providing best traction and top stability even on rugged and uneven terrains. The combination of tread resistance and the particular shoulder design stand for optimum self-cleaning properties along with a long tire life making FORESTMAX your ideal partner in the forest.

Ø 28"	Tire size	RIM		S.W. (mm)	O.D. (mm)	SLR (mm)	RC (mm)	Version	PR	Type	LI/SS	Load capacity (kg/tire)						
		Rec.	Alt.									km/h - bar						
		1.2	1.4									1.6	1.8	2.0	2.2	2.4		
540/65R28	W 18 L	-	550	1413	649	4247	SB	-	TL	149A8/ 146B	50	2040	2280	2340	2580	2790	2880	3000
											40	2210	2470	2535	2795	3020	3120	3250
											30	2370	2645	2715	2995	3235	3345	3480
											25	2455	2745	2815	3105	3355	3470	3610
											20	2720	3040	3120	3440	3720	3840	4000
											15	2965	3310	3395	3745	4050	4185	4355
											10	3315	3705	3800	4190	4530	4680	4875
											10 forestry service	-	-	-	-	-	-	4000
											0 forestry service	-	-	-	-	-	-	7475

Ø 38"	Tire size	RIM Rec.	RIM Alt.	S.W. (mm)	O.D. (mm)	SLR (mm)	RC (mm)	Version	PR	Type	LI/SS	Load capacity (kg/tire)						
												km/h - bar						
												1.2	1.4	1.6	1.8	2.0	2.2	2.4
650/65R38	DW 20 B	DW21B; DW23B	645	1811	832	5467	SB	-	TL	164A8/ 160B	50	3060	3420	3510	3870	4185	4320	4500
											40	3400	3800	3900	4300	4650	4800	5000
											30	3640	4070	4175	4600	4975	5140	5350
											25	3775	4220	4330	4775	5160	5330	5550
											20	4185	4675	4795	5290	5715	5905	6150
											15	4560	5095	5225	5760	6230	6435	6700
											10	5100	5700	5850	6450	6970	7200	7500
											10 forestry service	-	-	-	-	-	-	6150
											0 forestry service	-	-	-	-	-	-	11500

SB: Steel Belted

Technologies



Strong Casing



Steel Belted



Special Compound

Performance



Cut and Chip Resistance



Traction



Stability



Self-Cleaning



High Puncture Resistance



Durability

MULTIUSE





MULTIUSE

Radial



MULTIMAX MP 513

MULTIMAX MP 513 has been designed by BKT for multi-purpose vehicles in municipality/maintenance and transport applications, for both agricultural and industrial uses. It is perfect for universal vehicles and fertilizer trucks. Thanks to the strong steel-belted nylon casing, MULTIMAX MP 513 allows to carry heavy loads at high speeds providing a comfortable driving experience. It ensures a longer service life and traction along with outstanding self-cleaning properties.

MULTIMAX

RADIAL MPT TIRES

Ø 16"	Tire size	LI/SS	RIM		S.W. (mm)	O.D. (mm)	SLR (mm)	RC (mm)	SRI (index)	Version	Load capacity (kg/tire)								
			Rec.	Alt.							km/h - bar	1.6	2.0	2.5	3.0	3.5	4.0		
285/80 R 16 MPT	128 G	W 10	-	304	866	394	2617	-	STD	90	840	985	1180	1360	1540	1800			
										65	905	1065	1270	1465	1660	1945			
										40	965	1135	1355	1560	1770	2070			
Ø 17"	425/55 R 17 MPT	134 G	13	13.00	421	900	399	2695	-	STD	90	1080	1280	1550	1830	2120			
											65	1175	1390	1685	1990	2305			
											40	1245	1475	1785	2105	2440			
	425/55 R 17 MPT	142 A8/B	13	13.00	421	900	399	2705	-	STD	50	1035	1275	1515	1725	1965	2200	2440	2650
											40	1035	1275	1515	1725	1965	2200	2440	2650
											30	1110	1365	1620	1850	2105	2360	2530	2840
25	1150	1415	1680	1915	2180	2445	2625	2945											
Ø 18"	325/70 R 18 MPT	132 G	W 10	-	322	916	410	2771	-	STD	90	1095	1285	1530	1770	2000			
											65	1180	1390	1650	1915	2160			
											40	1255	1480	1760	2040	2300			
	365/70 R 18 MPT	133 G	11	11 SDC ; 12 ; 12 SDC	360	969	448	2954	475	STD	90	1080	1280	1520	1760	2000	2060		
											65	1170	1380	1650	1910	2170	2240		
											40	1250	1470	1750	2020	2300	2370		
Ø 20"	375/70 R 20 MPT	136 G	12	W 10 ; DW 10 ; 11 ; 11 SDC ; W 11 ; DW 11 ; 12 SDC	377	1034	472	3121	-	STD	90	1210	1435	1705	1975	2240			
											65	1315	1560	1855	2145	2435			
											40	1395	1655	1965	2275	2580			
	405/70 R 20 MPT	136 G	13	13 SDC ; 12 SDC	407	1076	493	3253	-	STD	90	1340	1580	1820	2040	2240			
											65	1455	1715	1975	2215	2435			
											40	1545	1820	2095	2350	2580			

STD: Standard

Technologies



High Speed



Steel Belted

Performance



Durability



Handling and Comfort



Self-Cleaning



Traction

MULTIMAX MP 513

Ø 20"	Tire size	LI/SS	RIM		S.W. (mm)	O.D. (mm)	SLR (mm)	RC (mm)	SRI (index)	Version	Load capacity (kg/tire)						
			Rec.	Alt.							km/h - bar	1.6	2.0	2.5	3.0	3.5	4.0
425/75 R 20 MPT	148 G	13	13 SDC ; 11 SDC ; 12 SDC ; 11 ; 12		421	1146	521	3479	-	STD	90	1540	1810	2150	2490	2820	3150
											65	1675	1965	2335	2705	3060	3420
											40	1775	2085	2475	2865	3245	3625

Ø 24"	Tire size	LI/SS	W	D	S.W. (mm)	O.D. (mm)	SLR (mm)	RC (mm)	SRI (index)	Version	Load capacity (kg/tire)					
											km/h - bar	1.6	2.0	2.5	3.0	3.5
65	2150	2540	3085	3530	4205											
40	2280	2695	3270	3740	4460											

STD: Standard

Technologies



Performance





MULTIUSE

Radial



MULTIMAX MP 515

MULTIMAX MP 515 is an agro-industrial radial tire designed for universal vehicles and fertilizer trucks. It is suitable for municipality and transport applications. The tire shows a unique tread design providing superior riding comfort on the road as well as excellent self-cleaning properties and great traction. The strong steel-belted nylon casing and the reinforced shoulder ensure extraordinary durability. MULTIMAX MP 515 is the perfect tire also at high speeds (90km/h).

MULTIMAX
RADIAL MPT TIRES

Ø 20"	Tire size	LI/SS	RIM		S.W. (mm)	O.D. (mm)	SLR (mm)	RC (mm)	SRI (index)	Version	Load capacity (kg/tire)								
			Rec.	Alt.							km/h - bar								
											1.6	2.0	2.5	3.0	3.5				
405/70 R 20 MPT	136 G	13	13 SDC; 12 SDC; 11 SDC;11	407	1076	493	3286	-	STD	90	1340	1580	1820	2040	2240				
										65	1455	1715	1975	2215	2435				
										40	1545	1820	2095	2350	2580				
425/75 R 20 MPT	148 G	13	13 SDC; 11 SDC; 12 SDC; 11;12	421	1146	522	3491	-	STD	90	1540	1810	2150	2490	2820	3150			
										65	1675	1965	2335	2705	3060	3420			
										40	1775	2085	2475	2865	3245	3625			
Ø 22.5"	445/65 R 22.5 MPT	160 G	13	14	444	1150	527	3532	-	STD	90	1740	2060	2410	2750	3075	3390	3800	4500
											65	1890	2235	2615	2985	3340	3675	4000	4885
											40	2005	2365	2770	3165	3540	3900	4240	5175
																	1.6	2.0	2.5

STD: Standard

Technologies



High Speed



Reinforced Shoulder



Steel Belted

Performance



Durability



Handling and Comfort



Self-Cleaning



Traction



MULTIUSE

Radial



MULTIMAX MP 519

MULTIMAX MP 519 is a particularly suitable tire for light trucks in all transport applications. The steel-belted casing provides excellent stability at high-speed (90 km/h - 60 mph). Thanks to its low rolling resistance, the tire ensures reduced fuel consumption.

MULTIMAX
RADIAL MPT TIRES

Ø 16"	Tire size	LI/SS	RIM		S.W. (mm)	O.D. (mm)	SLR (mm)	RC (mm)	SRI (index)	Version	Load capacity (kg/tire)	
			Rec.	Alt.							km/h - bar	3.5
											90 LS	90 LD
7.50 R 16 LT	109/107 G	6.00	5.50 F; 6 L;7 L	220	810	377	2449	-	STD	90 LS	1030	
										90 LD	975	
												3.5
7.50 R 16 LT	112/110 G	6.00	5.50 F; 6 L;7 L	220	810	377	2449	-	STD	90 LS	1120	
										90 LD	1060	
												3.5

STD: Standard

Technologies



High Speed

Performance



Fuel Economy



Stability



MULTIMAX MP 522

MULTIMAX MP 522 is the BKT multi-purpose tire developed for agro-industrial applications. It is suitable for all lifting and loading operations on vehicles such as telehandlers and compact loaders. Stability and traction are its strengths as well as outstanding puncture resistance. Thanks to its special compound, MULTIMAX MP 522 has an incredible cut and chip resistance.

MULTIMAX
RADIAL MPT TIRES

Ø 18"	Tire size	LI/SS	RIM		S.W. (mm)	O.D. (mm)	SLR (mm)	RC (mm)	SRI (index)	Version	Load capacity (kg/tire)									
			Rec.	Alt.							km/h - bar	1.6	2.0	2.4	2.8	3.2	3.5	4.0	4.2	4.4
280/80 R 18 IND (10.5/80 R 18)	132 A8/B	W 9 ; 9 ; 9 SDC	W 8 ; W 10	282	907	421	2748	425	STD	km/h - bar	1.6	2.0	2.4	2.8	3.2	3.5	4.0	4.2	4.4	
										50	960	1140	1300	1480	1660	1780	2000	-	-	
										40	960	1140	1300	1480	1660	1780	2000	-	-	
										30	1030	1220	1395	1585	1780	1905	2140	-	-	
										25	1070	1270	1445	1645	1845	1980	2220	-	-	
										10 Cyc.	1170	1440	1695	1950	2220	2415	2730	2880	3000	
Static	1795	2210	2600	2990	3405	3705	4190	4420	4600											
340/80 R 18 IND (12.5/80 R 18)	143 A8/B	11 ; 11 SDC ; W 11	W 10 ; 12 ; 12 SDC	343	1006	458	3023	475	STD	km/h - bar	1.6	2.0	2.4	2.8	3.2	3.5	4.0	4.2	4.4	
										50	1310	1555	1775	2020	2265	2430	2725	-	-	
										40	1310	1555	1775	2020	2265	2430	2725	-	-	
										30	1405	1665	1900	2165	2425	2600	2920	-	-	
										25	1455	1725	1970	2240	2515	2695	3025	-	-	
										10 Cyc.	1600	1965	2315	2660	3030	3295	3725	3930	4090	
Static	2450	3010	3545	4080	4640	5050	5710	6020	6270											
Ø 20"	340/80 R 20 IND	144 A8/B	11	W10 ; 11 SDC ; W11 ; 12 ; 12 SDC	343	1052	481	3212	500	STD	km/h - bar	1.6	2.0	2.4	2.8	3.2	3.5	4.0	4.2	4.4
											50	1345	1600	1820	2075	2325	2495	2800	-	-
											40	1345	1600	1820	2075	2325	2495	2800	-	-
											30	1440	1710	1950	2220	2490	2670	3000	-	-
											25	1495	1775	2025	2305	2585	2770	3110	-	-
											10 Cyc.	1640	2020	2375	2730	3110	3385	3825	4035	4200
Static	2515	3095	3640	4190	4770	5185	5865	6185	6440											
380/75 R 20 IND (14.5 R 20)	148 A8/B	W 12	W 11 ; 11 ; 12	384	1074	483	3251	500	STD	km/h - bar	1.6	2.0	2.4	2.8	3.2	3.6	3.8	4.0	4.2	4.4
										50	1500	1770	2040	2305	2575	2860	3005	3150	-	-
										40	1500	1770	2040	2305	2575	2860	3005	3150	-	-
										30	1610	1900	2195	2490	2780	3075	3220	3370	-	-
										25	1670	1975	2280	2585	2890	3195	3350	3500	-	-
										10 Cyc.	1850	2260	2670	3080	3490	3900	4110	4315	4520	4730
Static	2840	3470	4100	4730	5360	5990	6305	6620	6935	7250										
400/70 R 20 IND (16.0/70 R 20)	149 A8/B	13	12 SDC ; 13 SDC ; 14	404	1068	476	3222	525	STD	km/h - bar	1.6	2.0	2.4	2.8	3.2	3.5	4.0	4.2	4.4	
										50	1560	1855	2115	2405	2700	2895	3250	-	-	
										40	1560	1855	2115	2405	2700	2895	3250	-	-	
										30	1675	1985	2265	2580	2890	3100	3480	-	-	
										25	1735	2060	2350	2675	3000	3215	3610	-	-	
										10 Cyc.	1905	2340	2755	3170	3610	3925	4440	4680	4875	
Static	2920	3590	4225	4860	5535	6020	6805	7180	7475											
Ø 24"	400/70 R 24 IND	152 A8/B	13	DW 12 ; 13 SDC ; DW 13 ; DW 13 L ; DW 14 L	404	1170	533	3527	575	STD	km/h - bar	1.6	2.0	2.4	2.8	3.2	3.5	4.0	4.2	4.4
											50	1705	2025	2310	2630	2950	3160	3550	-	-
											40	1705	2025	2310	2630	2950	3160	3550	-	-
											30	1825	2170	2470	2815	3155	3385	3800	-	-
											25	1895	2250	2565	2920	3275	3515	3945	-	-
											10 Cyc.	2080	2560	3010	3465	3945	4290	4850	5115	5325
Static	3185	3920	4615	5310	6045	6575	7435	7840	8165											

Technologies



Performance



STD: Standard

Ø 24"	Tire size	LI/SS	RIM		S.W. (mm)	O.D. (mm)	SLR (mm)	RC (mm)	SRI (index)	Version	Load capacity (kg/tire)																
			Rec.	Alt.							km/h - bar																
											1.6	2.0	2.4	2.8	3.2	3.4	3.6	4.0	4.4	4.6	4.8	5.0	5.2	5.4			
400/80 R 24 IND	162 A8/B	DW 13	DW 12; DW 13 L; DW 14 L	404	1250	553	3778	600	STD	50	1855	2185	2565	2900	3230	3350	3520	3895	4220	4435	4540	4750	-	-			
										40	1855	2185	2565	2900	3230	3350	3520	3895	4220	4435	4540	4750	-	-			
										30	1985	2340	2750	3105	3460	3590	3770	4170	4515	4745	4860	5085	-	-			
										25	2060	2430	2850	3220	3590	3725	3910	4330	4690	4925	5040	5275	-	-			
										10 Cyc.	2280	2785	3280	3850	4350	4600	4845	5280	5845	6090	6330	6655	6810	7125			
										Static	3500	4270	5030	5900	6670	7050	7430	8100	8960	9340	9710	10205	10445	10925			
										km/h - bar	1.6	2.0	2.4	2.8	3.2	3.5	4.0	4.2	4.4	-	-	-	-	-	-		
50	2220	2640	3010	3425	3840	4120	4625	-	-	-	-	-	-	-	-												
40	2220	2640	3010	3425	3840	4120	4625	-	-	-	-	-	-	-	-												
30	2380	2825	3220	3665	4110	4410	4950	-	-	-	-	-	-	-	-												
25	2465	2930	3340	3800	4265	4575	5135	-	-	-	-	-	-	-	-												
10 Cyc.	2710	3335	3925	4515	5140	5590	6320	6665	6940	-	-	-	-	-	-												
Static	4150	5110	6015	6920	7875	8570	9685	10215	10640	-	-	-	-	-	-												
440/80 R 24 IND	161 A8/B	DW 14 L	DW 13; DW 13 L; DW 15 L	441	1314	586	3958	625	STD	50	2100	2495	2845	3240	3635	3895	4375	-	-	-	-	-					
										40	2100	2495	2845	3240	3635	3895	4375	-	-	-	-	-	-				
										30	2250	2675	3050	3470	3890	4170	4685	-	-	-	-	-	-				
										25	2335	2775	3160	3600	4035	4330	4860	-	-	-	-	-	-				
										10 Cyc.	2565	3155	3710	4270	4860	5285	5975	6305	6565	-	-	-	-	-			
										Static	3930	4835	5690	6545	7450	8105	9160	9665	10065	-	-	-	-	-			
										km/h - bar	1.6	2.0	2.4	2.8	3.2	3.5	4.0	4.2	4.4	-	-	-	-	-	-		
50	2400	2850	3250	3700	4150	4450	5000	-	-	-	-	-	-	-	-												
40	2400	2850	3250	3700	4150	4450	5000	-	-	-	-	-	-	-	-												
30	2570	3050	3480	3960	4445	4765	5350	-	-	-	-	-	-	-	-												
25	2665	3165	3610	4110	4610	4940	5550	-	-	-	-	-	-	-	-												
10 Cyc.	2925	3600	4240	4875	5550	6040	6825	7200	7500	-	-	-	-	-	-												
Static	4485	5520	6500	7475	8510	9260	10465	11040	11500	-	-	-	-	-	-												
460/70 R 24 IND (17.5L R 24)	159 A8/B	DW 15 L	DW 14 L; DW 16 L	465	1250	568	3766	600	STD	50	2690	3195	3640	4145	4650	4985	5600	-	-	-	-	-					
										40	2690	3195	3640	4145	4650	4985	5600	-	-	-	-	-	-				
										30	2880	3420	3900	4440	4980	5340	5995	-	-	-	-	-	-				
										25	2990	3550	4045	4605	5165	5540	6220	-	-	-	-	-	-				
										10 Cyc.	3280	4035	4750	5460	6220	6765	7645	8065	8400	-	-	-	-	-			
										Static	5025	6185	7280	8375	9535	10370	11725	12365	12880	-	-	-	-	-			
										km/h - bar	1.6	2.0	2.4	2.8	3.2	3.5	4.0	4.2	4.4	-	-	-	-	-	-		
50	2610	3060	3330	3555	3780	4005	4275	4500	-	-	-	-	-	-	-												
40	2610	3060	3330	3555	3780	4005	4275	4500	-	-	-	-	-	-	-												
30	2795	3275	3565	3805	4045	4290	4575	4815	-	-	-	-	-	-	-												
25	2900	3400	3700	3950	4200	4450	4750	4995	-	-	-	-	-	-	-												
10 Cyc.	3175	3915	4255	4590	4995	5335	5670	6075	6415	6750	-	-	-	-	-												
Static	4865	6005	6525	7040	7660	8180	8695	9315	9835	10350	-	-	-	-	-												
Ø 26"	480/80 R 26 IND	160 A8/B	DW 15 L	DW 16 L	479	1428	638	4287	675	STD	50	2575	2815	3055	3295	3540	3780	4020	4260	4500	4740	4975	5215	5450	-	-	
											40	2575	2815	3055	3295	3540	3780	4020	4260	4500	4740	4975	5215	5450	-	-	
											30	2790	3045	3300	3550	3805	4060	4315	4565	4820	5075	5330	5580	5835	-	-	
											25	2890	3155	3420	3680	3945	4210	4475	4735	5000	5265	5525	5790	6050	-	-	
											10 Cyc.	3200	3555	3910	4265	4620	4975	5330	5685	6040	6395	6750	7105	7460	7815	-	-
											Static	4900	5445	5990	6535	7080	7625	8170	8715	9260	9805	10350	10895	11445	11990	12535	
											km/h - bar	1.6	1.8	2.0	2.2	2.4	2.6	2.8	3.0	3.2	3.4	3.6	3.8	4.0	4.2	4.4	

Technologies



Performance



STD: Standard

MULTIMAX MP 522

Ø 28"	Tire size	LI/SS	RIM		S.W. (mm)	O.D. (mm)	SLR (mm)	RC (mm)	SRI (index)	Version	Load capacity (kg/tire)									
			Rec.	Alt.																
											km/h - bar	1.6	2.0	2.2	2.4	2.6	2.8	3.0	3.2	3.4
440/80 R 28 IND	156 A8/B	DW 14 L	DW 13 ; DW 13 L ; DW 15 L	441	1415	643	4278	675	STD	50	2300	2725	2940	3150	3360	3575	3790	4000	-	-
										40	2300	2725	2940	3150	3360	3575	3790	4000	-	-
										30	2480	2930	3155	3380	3605	3830	4055	4280	-	-
										25	2570	3040	3270	3505	3740	3970	4205	4440	-	-
										10 Cyc.	2840	3470	3790	4105	4420	4735	5050	5370	5685	6000
										Static	4360	5330	5810	6295	6780	7265	7750	8230	8715	9200

STD: Standard

Technologies



Performance





MULTIUSE

Radial



MULTIMAX MP 527

MULTIMAX MP 527 is a multi-purpose radial tire designed for telehandlers and compact loaders in agro-industrial applications. The tire shows a block pattern design providing excellent traction even on the harder surfaces. The strong sidewall ensures outstanding stability in lift mode. MULTIMAX MP 527 is made of a special cut-and-chip-resistant compound providing and a long service life.

MULTIMAX
RADIAL MPT TIRES

Ø 18"	Tire size	LI/SS	RIM		S.W. (mm)	O.D. (mm)	SLR (mm)	RC (mm)	SRI (index)	Version	Load capacity (kg/tire)									
			Rec.	Alt.							km/h - bar									
											1.6	2.0	2.4	2.8	3.2	3.5	4.0	4.2	4.4	
340/80 R 18 IND	143 A8/B	11 ; 11 SDC ; W 11	W 10 ; 12 ; 12 SDC	343	1001	455	3028	475	STD	50	1310	1555	1775	2020	2265	2430	2725	-	-	
										40	1310	1555	1775	2020	2265	2430	2725	-	-	
										30	1405	1665	1900	2165	2425	2600	2920	-	-	
										25	1455	1725	1970	2240	2515	2695	3025	-	-	
										10 Cyc.	1600	1965	2315	2660	3030	3295	3725	3930	4090	
										Static	2450	3010	3545	4080	4640	5050	5710	6020	6270	
360/70 R 18 IND	142 A8/B	11	W10 ; W11 ; 12 ; 12 SDC	360	969	439	2887	475	STD	50	1275	1515	1725	1965	2200	2360	2650	-	-	
										40	1275	1515	1725	1965	2200	2360	2650	-	-	
										30	1365	1620	1850	2105	2360	2530	2840	-	-	
										25	1415	1680	1915	2180	2445	2625	2945	-	-	
										10 Cyc.	1555	1910	2250	2585	2945	3200	3620	3820	3975	
										Static	2380	2930	3445	3965	4515	4910	5550	5855	6095	
Ø 20"	340/80 R 20 IND	144 A8/B	11	W10 ; 11 SDC ; W11 ; 12 ; 12 SDC	343	1052	483	3176	500	STD	50	1345	1600	1820	2075	2325	2495	2800	-	-
											40	1345	1600	1820	2075	2325	2495	2800	-	-
											30	1440	1710	1950	2220	2490	2670	3000	-	-
											25	1495	1775	2025	2305	2585	2770	3110	-	-
											10 Cyc.	1640	2020	2375	2730	3110	3385	3825	4035	4200
											Static	2515	3095	3640	4190	4770	5185	5865	6185	6440
400/70 R 20 IND (16.0/70 R 20)	149 A8/B	13	12 SDC ; 13 SDC ; 14	404	1068	494	3282	525	STD	50	1560	1855	2115	2405	2700	2895	3250	-	-	
										40	1560	1855	2115	2405	2700	2895	3250	-	-	
										30	1675	1985	2265	2580	2890	3100	3480	-	-	
										25	1735	2060	2350	2675	3000	3215	3610	-	-	
										10 Cyc.	1905	2340	2755	3170	3610	3925	4440	4680	4875	
										Static	2920	3590	4225	4860	5535	6020	6805	7180	7475	
Ø 24"	400/70 R 24 IND	152 A8/B	13	DW 12 ; DW 13 ; DW 13 L ; 13 SDC ; DW 14 L	404	1170	542	3597	575	STD	50	1705	2025	2310	2630	2950	3160	3550	-	-
											40	1705	2025	2310	2630	2950	3160	3550	-	-
											30	1825	2170	2470	2815	3155	3385	3800	-	-
											25	1895	2250	2565	2920	3275	3515	3945	-	-
											10 Cyc.	2080	2560	3010	3465	3945	4290	4850	5115	5325
											Static	3185	3920	4615	5310	6045	6575	7435	7840	8165

STD: Standard

Technologies



Block Pattern

Performance



Cut and Chip Resistance



Hard Surfaces



High Load Capacity



Stability



Traction



Ø 24"	Tire size	LI/SS	RIM		S.W. (mm)	O.D. (mm)	SLR (mm)	RC (mm)	SRI (index)	Version	Load capacity (kg/tire)													
			Rec.	Alt.							km/h - bar													
											1.6	2.0	2.4	2.8	3.2	3.4	3.6	4.0	4.4	4.6	4.8	5.0	5.2	5.4
400/80 R 24 IND	162 A8/B	DW 13	DW 12 ; DW 13 L ; DW 14 L	404	1250	578	3834	600	STD	50	1855	2185	2565	2900	3230	3350	3520	3895	4220	4435	4540	4750	-	-
										40	1855	2185	2565	2900	3230	3350	3520	3895	4220	4435	4540	4750	-	-
										30	1985	2340	2750	3105	3460	3590	3770	4170	4515	4745	4860	5085	-	-
										25	2060	2430	2850	3220	3590	3725	3910	4330	4690	4925	5040	5275	-	-
										10 Cyc.	2280	2785	3280	3850	4350	4600	4845	5280	5845	6090	6330	6655	6810	7125
										Static	3500	4270	5030	5900	6670	7050	7430	8100	8960	9340	9710	10205	10445	10925
440/80 R 24 IND	161 A8/B	DW 14 L	DW 13 ; DW 13 L ; DW 15 L	441	1314	601	3985	625	STD	50	2220	2640	3010	3425	3840	4120	4625	-	-	-	-	-		
										40	2220	2640	3010	3425	3840	4120	4625	-	-	-	-	-		
										30	2380	2825	3220	3665	4110	4410	4950	-	-	-	-	-		
										25	2465	2930	3340	3800	4265	4575	5135	-	-	-	-	-		
										10 Cyc.	2710	3335	3925	4515	5140	5590	6320	6665	6940	-	-	-		
										Static	4150	5110	6015	6920	7875	8570	9685	10215	10640	-	-	-		
460/70 R 24 IND (17.5L R 24)	159 A8/B	DW 15 L	DW 14 L ; DW 16 L	465	1254	574	3801	600	STD	50	2100	2495	2845	3240	3635	3895	4375	-	-	-	-			
										40	2100	2495	2845	3240	3635	3895	4375	-	-	-	-			
										30	2250	2675	3050	3470	3890	4170	4685	-	-	-	-			
										25	2335	2775	3160	3600	4035	4330	4860	-	-	-	-			
										10 Cyc.	2565	3155	3710	4270	4860	5285	5975	6305	6565	-	-			
										Static	3930	4835	5690	6545	7450	8105	9160	9665	10065	-	-			
500/70 R 24 IND	164 A8/B	DW 16 L	DW 15 L ; DW 18 L	503	1310	597	4019	625	STD	50	2400	2850	3250	3700	4150	4450	5000	-	-	-	-			
										40	2400	2850	3250	3700	4150	4450	5000	-	-	-	-			
										30	2570	3050	3480	3960	4445	4765	5350	-	-	-	-			
										25	2665	3165	3610	4110	4610	4940	5550	-	-	-	-			
										10 Cyc.	2925	3600	4240	4875	5550	6040	6825	7200	7500	-	-			
										Static	4485	5520	6500	7475	8510	9260	10465	11040	11500	-	-			
Ø 26"	480/80 R 26 IND	160 A8/B	DW 15 L	DW 16 L	479	1428	642	4259	675	STD	50	2610	3060	3330	3555	3780	4005	4275	4500	-	-	-		
											40	2610	3060	3330	3555	3780	4005	4275	4500	-	-	-		
											30	2795	3275	3565	3805	4045	4290	4575	4815	-	-	-		
											25	2900	3400	3700	3950	4200	4450	4750	4995	-	-	-		
											10 Cyc.	3175	3915	4255	4590	4995	5335	5670	6075	6415	6750	-		
											Static	4865	6005	6525	7040	7660	8180	8695	9315	9835	10350	-		
Ø 28"	440/80 R 28 IND	156 A8/B	DW 14 L	DW 13 ; DW 13 L ; DW 15 L	441	1415	648	4270	675	STD	50	2300	2725	2940	3150	3360	3575	3790	4000	-	-	-		
											40	2300	2725	2940	3150	3360	3575	3790	4000	-	-	-		
											30	2480	2930	3155	3380	3605	3830	4055	4280	-	-	-		
											25	2570	3040	3270	3505	3740	3970	4205	4440	-	-	-		
											10 Cyc.	2840	3470	3790	4105	4420	4735	5050	5370	5685	6000	-		
											Static	4360	5330	5810	6295	6780	7265	7750	8230	8715	9200	-		

STD: Standard

Technologies



Block Pattern

Performance



Cut and Chip Resistance



Hard Surfaces



High Load Capacity



Stability



Traction



MULTIUSE

Radial



MULTIMAX MP 529

MULTIMAX MP 529 is a steel belted multi-purpose radial tire designed for telehandlers in industrial applications. Its tread design has been specially developed for hard surfaces. The strong sidewall and the larger footprint area ensure outstanding stability in lift mode. MULTIMAX MP 529 also features a strong puncture-resistant casing and is made of a special cut-and-chip-resistant compound providing extraordinary durability and a long service life.

MULTIMAX
RADIAL MPT TIRES

Ø 18"	Tire size	LI/SS	RIM		S.W. (mm)	O.D. (mm)	SLR (mm)	RC (mm)	SRI (index)	Version	Load capacity (kg/tire)									
			Rec.	Alt.							km/h - bar	1.6	2.0	2.4	2.8	3.2	3.5	4.0	4.2	4.4
340/80 R 18	143 A8/B	11; 11 SDC; W 11	W 10; 12; 12 SDC	343	1001	445	3007	475	STD	50	1310	1555	1775	2020	2265	2430	2725	-	-	
										40	1310	1555	1775	2020	2265	2430	2725	-	-	
										30	1405	1665	1900	2165	2425	2600	2920	-	-	
										25	1455	1725	1970	2240	2515	2695	3025	-	-	
										10 Cyc.	1600	1965	2315	2660	3030	3295	3725	3930	4090	
Static	2450	3010	3545	4080	4640	5050	5710	6020	6270											

STD: Standard

Technologies



Larger Footprint



Steel Belted

Performance



Cut and Chip Resistance



Durability



Hard Surfaces



High Puncture Resistance



Stability





MULTIUSE

Radial



MULTIMAX MP 540

MULTIMAX MP 540 has been designed by BKT for multi-purpose vehicles in municipality/maintenance applications. It is suitable for all universal vehicles. Thanks to the All Steel casing, MULTIMAX MP 540 enables to carry heavy loads at high speeds. In addition, its block pattern design provides outstanding stability and durability.

MULTIMAX

RADIAL MPT TIRES

Ø 16"	Tire size	LI/SS	RIM		O.W. (mm)	O.D. (mm)	SLR (mm)	RC (mm)	SRI (index)	Version	Load capacity (kg/tire)											
			Rec.	Alt.							km/h - bar											
Ø 16"	315/55 R 16	120 K / 124 F	W 10 L	11	305	751	354	2325	-	STD	110	1400										
											80	1600										
											km/h - bar		4.00									
Ø 18"	335/80 R 18 (12.5 R 18)	132 K	11	-	340	985	446	3000	-	STD	110	2000										
											km/h - bar		3.50									
											km/h - bar		5.20									
Ø 20"	275/80 R 20 (10.5 R 20)	134 K	W9	9	270	955	443	2913	-	STD	110	2120										
											km/h - bar		5.20									
	335/80 R 20	149 K	11	-	340	1044	492	3258	-	STD	110	2205	4.0	2420	5.0	2635	5.5	2845	6.0	3050	6.5	3250
											100	2205	2420	2635	2845	3050	3250					
											90	2250	2470	2685	2900	3110	3315					
											80	2290	2520	2740	2955	3170	3380					
											70	2360	2595	2820	3045	3265	3480					
	km/h - bar		6.25																			
	365/80 R 20 (14.5 R 20)	152 K	11	-	365	1086	495	3308	-	STD	110	3550										
											km/h - bar		6.00									
405/70 R 20 (16.0/70 R 20)	152 K	13	12; 13 SDC	402	1082	490	3295	-	STD	110	3550											
										km/h - bar		5.00										
Ø 24"	405/70 R 24 (16.0/70 R 24)	152 J	13	-	402	1174	530	3586	-	STD	100	3550										
											km/h - bar		5.00									

Technologies



Performance



STD: Standard





MULTIUSE

Radial



MULTIMAX MT 518

MULTIMAX MT 518 has been specially designed for military trucks. It is a block pattern and steel-belted tire featuring high puncture resistance as well as outstanding stability. Besides, MULTIMAX MT 518 withstands high speed and provides an extended tire life-cycle.

MULTIMAX
RADIAL MPT TIRES

Ø 16.5"	Tire size	LI/SS	RIM		S.W. (mm)	O.D. (mm)	SLR (mm)	RC (mm)	SRI (index)	Version	Load capacity (kg/tire)	
			Rec.	Alt.							km/h - bar	
36 X 12.5 R 16.5	129 N	9.75	-	315	902	420	2758	-	STD	140	1850	

STD: Standard

Technologies



High Speed



Steel Belted

Performance



Durability



High Puncture Resistance



Stability





MULTIUSE

Radial



MULTIMAX MP 538

MULTIMAX MP 538 is a radial multipurpose tire specifically designed for several applications and machineries: graders and loaders operating in winter conditions, as well as telehandlers, universal vehicles and sweepers in road maintenance. Thanks to the strong steel-belted casing, MULTIMAX MP 538 allows to carry heavy loads even at high speeds. In addition, its unique tread design helps maintaining excellent traction on ice and snow.

Ø 20"	Tire size	LI/SS	RIM		S.W. (mm)	O.D. (mm)	SLR (mm)	RC (mm)	SRI (index)	Version	Load capacity (kg/tire)	
			Rec.	Alt.							km/h - bar	6
	405/70 R 20 MPT	152 G	W 13	-	407	1076	484	3289	-	SB	90	3550
											65	3850
											40	4080

SB: Steel Belted

Technologies



High Speed



M+S



Steel Belted

Performance



Durability



High Load Capacity



Ice and Snow



Traction





MULTIUSE

Bias



CON STAR

CON STAR is particularly suitable for compact loaders and telehandlers in agro-industrial, lifting and loading applications. It features great traction along with excellent vertical and horizontal stability. CON STAR has been made of a cut-and-chip-resistant compound contributing to an extended tire life-cycle.

Ø 18"	Tire size	RIM		S.W. (mm)	O.D. (mm)	SLR (mm)	RC (mm)	Version	PR	Type	LI/SS	Load capacity (kg/tire)	
		Rec.	Alt.									km/h - bar	4.00
Ø 18"	340/80 - 18 (12.5/80 - 18)	11	12; 11 SDC; 12 SDC; W 10; W 11	350	1015	460	3075	IND	-	TL	143 A8	40	2725
												40	4.00
Ø 20"	340/80 - 20 (12.5/80 - 20)	11	12; 11 SDC; 12 SDC; W 10; W 11	350	1065	491	3272	IND	-	TL	144 A8	40	2800
												40	4.00
Ø 20"	380/75 - 20 (114.5 - 20)	W 12	W 11; 12 SDC; 12; W 13; 13 SDC; 13	385	1080	500	3273	IND	-	TL	148 A8	40	3150
												40	4.00
Ø 20"	400/70 - 20 (16.0/70 - 20)	13	12 SDC; 13 SDC; 14	405	1080	501	3303	IND	16	TL	149 A8	40	3250
												40	4.00
Ø 20"	400/70 - 20 (16.0/70 - 20)	13	12 SDC; 13 SDC; 14	405	1080	501	3303	IND	-	TL	156 A8	40	4000
												40	5.00
Ø 24"	400/70 - 24 (16.0/70 - 24)	13	DW 12; 13 SDC; DW 13; DW 13 L; DW 14 L	395	1175	544	3556	IND	-	TL	158 A8	40	4250
												40	5.00
Ø 24"	400/80 - 24 (15.5/80 - 24)	DW 13	DW 12; DW 13 L; DW 14 L	405	1250	570	3781	IND	20	TL	162 A8	40	4750
												40	5.00

Technologies



Special Compound

Performance



Cut and Chip Resistance



Stability



Traction

IND: Industrial





MULTIUSE

CON STAR

Ø 24"	Tire size	RIM		S.W. (mm)	O.D. (mm)	SLR (mm)	RC (mm)	Version	PR	Type	LI/SS	Load capacity (kg/tire)	
		Rec.	Alt.									km/h - bar	
												5.00	
	440/80 - 24 (17.0/80 - 24)	DW 14 L	DW 13 ; DW 13 L ; DW 15 L	455	1315	610	3986	IND	22	TL	168 A8	40	5600
												km/h - bar	4.00
	460/70 - 24 (17.0/80 - 24)	DW 15 L	DW 14 L ; DW 16 L	460	1250	562	3784	IND	-	TL	159 A8	40	4375
												km/h - bar	4.00
	500/70 - 24 (19.5L - 24)	DW 16 L	DW 15 L ; DW 18 L	505	1300	579	3926	IND	-	TL	164 A8	40	5000
												km/h - bar	3.20
	480/80 - 26 (18.4 - 26)	DW 15 L	DW 16 L	490	1410	643	4272	IND	-	TL	160 A8	40	4500
												km/h - bar	3.20
	440/80 - 28 (16.9 - 28)	DW 14 L	DW 13 ; DW 13 L ; DW 15 L	450	1420	632	4299	IND	-	TL	156 A8	40	4000
												km/h - bar	3.20

IND: Industrial

Technologies



Special Compound

Performance

Cut and Chip
Resistance

Stability



Traction

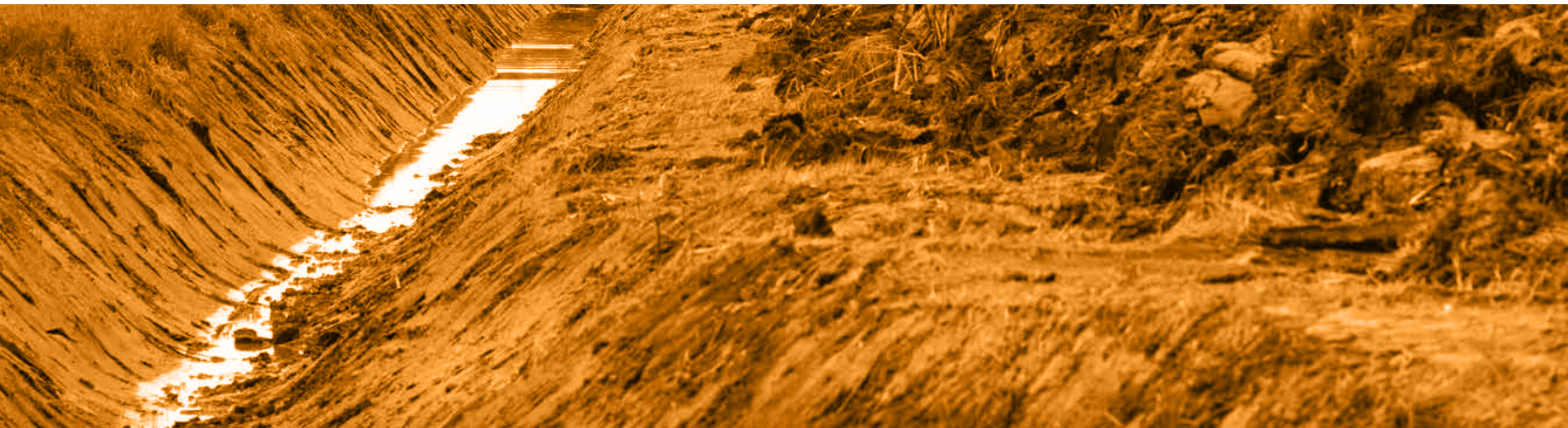



MULTIUSE

Bias



AS 504

AS 504 is an agro-industrial tire mainly designed for soil tillage, implement and material-handling operations. This tire, which features excellent self-cleaning properties and increased grip, is suitable for field trailers and telehandlers. AS 504 is available in several versions to meet specific end-user requirements: an "HD" version with a special cut-and-chip resistance compound, while the "special" version has a reinforced casing that ensures a longer tire life.

Ø 12"	Tire size	RIM		S.W. (mm)	O.D. (mm)	SLR (mm)	RC (mm)	Version	PR	Type	LI/SS Drive Wheel	LI/SS Free Rolling	Load capacity (kg/tire)	
		Rec.	Alt.										km/h - bar	
6.5/80 - 12	5 J	5 JA	169	608	283	1836	STD	4	TT	72 A8	84 A8	km/h - bar	2.40	
												10 FR	700	
												25 FR	595	
												30 FR	560	
												40 FR	500	
												10 DW	495	
												25 DW	420	
												30 DW	400	
40 DW	355													
6.5/80 - 12	5 J	5 JA	169	608	283	1836	STD	4	TL	72 A8	84 A8	km/h - bar	2.40	
												10 FR	700	
												25 FR	595	
												30 FR	560	
												40 FR	500	
												10 DW	495	
												25 DW	420	
												30 DW	400	
40 DW	355													
6.5/80 - 12	5 J	5 JA	169	608	283	1836	STD	6	TT	80 A8	93 A8	km/h - bar	3.60	
												10 FR	910	
												25 FR	775	
												30 FR	730	
												40 FR	650	
												10 DW	630	
												25 DW	535	
												30 DW	505	
40 DW	450													
6.5/80 - 12	5 J	5 JA	169	608	283	1836	STD	6	TL	80 A8	93 A8	km/h - bar	3.60	
												10 FR	910	
												25 FR	775	
												30 FR	730	
												40 FR	650	
												10 DW	630	
												25 DW	535	
												30 DW	505	
40 DW	450													

STD: Standard

Technologies



Heavy Duty



Reinforced Carcass



Aramid Belted

Performance



Cut and Chip Resistance



Durability



Self-Cleaning



Stability



Traction

Ø 12"	Tire size	RIM		S.W. (mm)	O.D. (mm)	SLR (mm)	RC (mm)	Version	PR	Type	LI/SS Drive Wheel	LI/SS Free Rolling	Load capacity (kg/tire)	
		Rec.	Alt.										km/h - bar	
6.5/80 - 12	5 J	5 JA	169	608	283	1836	HD	6	TT	80 A8	93 A8	3.60		
												10 FR	910	
												25 FR	775	
												30 FR	730	
												40 FR	650	
												10 DW	630	
												25 DW	535	
												30 DW	505	
40 DW	450													
7.00 - 12	4.5	-	187	683	300	2001	STD	6	TT	83 A8	95 A8	2.50		
												10 FR	965	
												25 FR	820	
												30 FR	775	
												40 FR	690	
												10 DW	680	
												25 DW	575	
												30 DW	545	
40 DW	485													
7.00 - 12	4.5	-	187	683	311	2049	STD	4	TT	75 A8	88 A8	1.70		
												10 FR	785	
												25 FR	665	
												30 FR	625	
												40 FR	560	
												10 DW	540	
												25 DW	460	
												30 DW	430	
40 DW	385													
7.00 - 12	4.5	-	187	683	311	2049	STD	4	TL	75 A8	88 A8	1.70		
												10 FR	785	
												25 FR	665	
												30 FR	625	
												40 FR	560	
												10 DW	540	
												25 DW	460	
												30 DW	430	
40 DW	385													
7.00 - 12	4.5	-	187	683	311	2049	STD	6	TL	83 A8	95 A8	2.50		
												10 FR	965	
												25 FR	820	
												30 FR	775	
												40 FR	690	
												10 DW	680	
												25 DW	575	
												30 DW	545	
40 DW	485													

STD: Standard - HD: Heavy Duty

Technologies



Heavy Duty



Reinforced Carcass



Aramid Belted

Performance



Cut and Chip Resistance



Durability



Self-Cleaning



Stability



Traction

Ø 12"	Tire size	RIM		S.W. (mm)	O.D. (mm)	SLR (mm)	RC (mm)	Version	PR	Type	LI/SS Drive Wheel	LI/SS Free Rolling	Load capacity (kg/tire)	
		Rec.	Alt.										km/h - bar	
7.00 - 12	4.5	-	187	683	311	2049	AB	8	TL	88 A8	100 A8	3.30		
												10 FR	1120	
												25 FR	950	
												30 FR	895	
												40 FR	800	
												10 DW	785	
												25 DW	665	
												30 DW	625	
40 DW	560													
7.00 - 12	4.5	-	187	683	311	2049	SPL	8	TL	88 A8	100 A8	3.30		
												10 FR	1120	
												25 FR	950	
												30 FR	895	
												40 FR	800	
												10 DW	785	
												25 DW	665	
												30 DW	625	
40 DW	560													
10.0/80 - 12	9.00	7.0	270	730	335	2233	STD	-	TL	109 A8	121 A8	3.90		
												10 FR	2030	
												25 FR	1725	
												30 FR	1625	
												40 FR	1450	
												10 DW	1440	
												25 DW	1225	
												30 DW	1155	
40 DW	1030													
11.0/65 - 12	9.00	-	273	700	321	2072	STD	8	TT	101 A8	114 A8	2.90		
												10 FR	1650	
												25 FR	1405	
												30 FR	1320	
												40 FR	1180	
												10 DW	1155	
												25 DW	980	
												30 DW	925	
40 DW	825													
11.0/65 - 12	9.00	-	273	700	321	2072	STD	8	TL	101 A8	114 A8	2.90		
												10 FR	1650	
												25 FR	1405	
												30 FR	1320	
												40 FR	1180	
												10 DW	1155	
												25 DW	980	
												30 DW	925	
40 DW	825													
26 X 12.00 - 12	10.50 AT	8.0 AT ; 8.5 AT ; 9.0 AT	310	648	298	1932	STD	-	TL	112 A6		3.0		
												30	1120	

Technologies



Heavy Duty



Reinforced Carcass



Aramid Belted

Performance



Cut and Chip Resistance



Durability



Self-Cleaning



Stability



Traction

STD: Standard - SPL: Special - AB: Aramid Belted

Ø 15"	Tire size	RIM		S.W. (mm)	O.D. (mm)	SLR (mm)	RC (mm)	Version	PR	Type	LI/SS Drive Wheel	LI/SS Free Rolling	Load capacity (kg/tire)	
		Rec.	Alt.										km/h - bar	
400/50 - 15	13 LB	-	395	790	369	2387	STD	-	TL	109 A8	121 A8	3.00		
												10 FR	2030	
												25 FR	1725	
												30 FR	1625	
												40 FR	1450	
												10 DW	1440	
												25 DW	1225	
												30 DW	1155	
40 DW	1030													
5.00 - 15	3.50 D	3.00 D ; 4.00 E ; 4 J	140	657	308	1957	STD	6	TT	75 A8	88 A8	3.50		
												10 FR	785	
												25 FR	665	
												30 FR	625	
												40 FR	560	
												10 DW	540	
												25 DW	460	
												30 DW	430	
40 DW	385													
5.00 - 15	3.50 D	3.00 D ; 4.00 E ; 4 J	140	657	308	1957	STD	6	TL	75 A8	88 A8	3.50		
												10 FR	785	
												25 FR	665	
												30 FR	625	
												40 FR	560	
												10 DW	540	
												25 DW	460	
												30 DW	430	
40 DW	385													
5.00 - 15	3.50 D	3.00 D ; 4.00 E ; 4 J	140	657	308	1957	STD	4	TT	67 A8	79 A8	230		
												10 FR	610	
												25 FR	520	
												30 FR	485	
												40 FR	435	
												10 DW	425	
												25 DW	365	
												30 DW	340	
40 DW	305													
7.5L - 15	6 LB	5 K ; 5½ J ; 5½ K	210	765	354	2280	STD	6	TT	97 A8	109 A8	3.10		
												10 FR	1440	
												25 FR	1225	
												30 FR	1155	
												40 FR	1030	
												10 DW	1020	
												25 DW	870	
												30 DW	820	
40 DW	730													

STD: Standard

Technologies

- Heavy Duty
- Reinforced Carcass
- Aramid Belted

Performance

- Cut and Chip Resistance
- Durability
- Self-Cleaning
- Stability
- Traction



Ø 15"	Tire size	RIM		S.W. (mm)	O.D. (mm)	SLR (mm)	RC (mm)	Version	PR	Type	LI/SS Drive Wheel	LI/SS Free Rolling	Load capacity (kg/tire)	
		Rec.	Alt.										km/h - bar	
Ø 15"	7.5L - 15	6 LB	5 K ; 5½ J ; 5½ K	210	765	354	2280	STD	8	TT	100 A8	113 A8	3.70	
													10 FR	1610
													25 FR	1370
													30 FR	1290
													40 FR	1150
													10 DW	1120
													25 DW	950
	30 DW	895												
	40 DW	800												
	7.5L - 15	6 LB	5 K ; 5½ J ; 5½ K	210	765	354	2280	STD	8	TL	100 A8	113 A8	3.70	
													10 FR	1610
													25 FR	1370
													30 FR	1290
40 FR													1150	
10 DW													1120	
25 DW													950	
30 DW	895													
40 DW	800													
7.5L - 15	6 LB	5 K ; 5½ J ; 5½ K	210	765	354	2280	AB HD	8	TL	100 A8	113 A8	3.70		
												10 FR	1610	
												25 FR	1370	
												30 FR	1290	
												40 FR	1150	
												10 DW	1120	
												25 DW	950	
30 DW	895													
40 DW	800													
7.5L - 15	6 LB	5 K ; 5½ J ; 5½	210	765	354	2280	HD	8	TT	100 A8	113 A8	3.70		
												10 FR	1610	
												25 FR	1370	
												30 FR	1290	
												40 FR	1150	
												10 DW	1120	
												25 DW	950	
30 DW	895													
40 DW	800													
Ø 15.3"	10.0/75 - 15.3	9.00	-	264	785	360	2404	STD	8	TT	106 A8	119 A8	3.10	
													10 FR	1905
													25 FR	1620
													30 FR	1525
													40 FR	1360
													10 DW	1330
													25 DW	1130
													30 DW	1065
													40 DW	950

STD: Standard - AB HD: Aramid Belted HD - HD: Heavy Duty

Technologies

- Heavy Duty
- Reinforced Carcass
- Aramid Belted

Performance

- Cut and Chip Resistance
- Durability
- Self-Cleaning
- Stability
- Traction

Ø 15.3"	Tire size	RIM		S.W. (mm)	O.D. (mm)	SLR (mm)	RC (mm)	Version	PR	Type	LI/SS Drive Wheel	LI/SS Free Rolling	Load capacity (kg/tire)	
		Rec.	Alt.										km/h - bar	
10.0/75 - 15.3	9.00	-	264	785	360	2404	STD	8	TL	106 A8	119 A8	3.10		
												10 FR	1905	
												25 FR	1620	
												30 FR	1525	
												40 FR	1360	
												10 DW	1330	
												25 DW	1130	
												30 DW	1065	
40 DW	950													
10.0/75 - 15.3	9.00	-	264	785	360	2404	STD	10	TL	111 A8	123 A8	3.90		
												10 FR	2170	
												25 FR	1845	
												30 FR	1735	
												40 FR	1550	
												10 DW	1525	
												25 DW	1295	
												30 DW	1220	
40 DW	1090													
10.0/75 - 15.3	9.00	-	264	785	360	2404	STD	14	TL	118 A8	130 A8	5.50		
												10 FR	2660	
												25 FR	2260	
												30 FR	2130	
												40 FR	1900	
												10 DW	1850	
												25 DW	1570	
												30 DW	1480	
40 DW	1320													
10.0/75 - 15.3	9.00	-	264	785	360	2404	STD	18	TT	123 A8	135 A8	7.10		
												10 FR	3050	
												25 FR	2595	
												30 FR	2440	
												40 FR	2180	
												10 DW	2170	
												25 DW	1845	
												30 DW	1735	
40 DW	1550													
10.0/75 - 15.3	9.00	-	264	785	360	2404	STD	18	TL	123 A8	135 A8	7.10		
												10 FR	3050	
												25 FR	2595	
												30 FR	2440	
												40 FR	2180	
												10 DW	2170	
												25 DW	1845	
												30 DW	1735	
40 DW	1550													

STD: Standard

Technologies



Heavy Duty



Reinforced Carcass



Aramid Belted

Performance



Cut and Chip Resistance



Durability



Self-Cleaning



Stability



Traction

Ø 15.3"	Tire size	RIM		S.W. (mm)	O.D. (mm)	SLR (mm)	RC (mm)	Version	PR	Type	LI/SS Drive Wheel	LI/SS Free Rolling	Load capacity (kg/tire)	
		Rec.	Alt.										km/h - bar	
10.0/75 - 15.3	9.00	-	264	785	360	2404	IND	8	TL	106 A8	119 A8	km/h - bar	3.10	
												10 FR	1905	
												25 FR	1620	
												30 FR	1525	
												40 FR	1360	
												10 DW	1330	
												25 DW	1130	
												30 DW	1065	
40 DW	950													
11.5/80 - 15.3	9.00	-	290	867	380	2540	STD	8	TT	114 A8	126 A8	km/h - bar	2.70	
												10 FR	2380	
												25 FR	2025	
												30 FR	1905	
												40 FR	1700	
												10 DW	1650	
												25 DW	1405	
												30 DW	1320	
40 DW	1180													
11.5/80 - 15.3	9.00	-	290	867	380	2540	STD	8	TL	114 A8	126 A8	km/h - bar	2.70	
												10 FR	2380	
												25 FR	2025	
												30 FR	1905	
												40 FR	1700	
												10 DW	1650	
												25 DW	1405	
												30 DW	1320	
40 DW	1180													
11.5/80 - 15.3	9.00	-	290	867	380	2540	STD	10	TL	119 A8	131 A8	km/h - bar	3.40	
												10 FR	2730	
												25 FR	2320	
												30 FR	2185	
												40 FR	1950	
												10 DW	1905	
												25 DW	1620	
												30 DW	1525	
40 DW	1360													
11.5/80 - 15.3	9.00	-	290	867	380	2540	STD	12	TT	123 A8	135 A8	km/h - bar	4.10	
												10 FR	3050	
												25 FR	2595	
												30 FR	2440	
												40 FR	2180	
												10 DW	2170	
												25 DW	1845	
												30 DW	1735	
40 DW	1550													

Technologies



Heavy Duty



Reinforced Carcass



Aramid Belted

Performance



Cut and Chip Resistance



Durability



Self-Cleaning



Stability



Traction

STD: Standard - IND: Industrial

Ø 15.3"	Tire size	RIM		S.W. (mm)	O.D. (mm)	SLR (mm)	RC (mm)	Version	PR	Type	LI/SS Drive Wheel	LI/SS Free Rolling	Load capacity (kg/tire)	
		Rec.	Alt.										km/h - bar	
11.5/80 - 15.3	9.00	-	290	867	380	2540	STD	12	TL	123 A8	135 A8	km/h - bar	4.10	
												10 FR	3050	
												25 FR	2595	
												30 FR	2440	
												40 FR	2180	
												10 DW	2170	
												25 DW	1845	
												30 DW	1735	
40 DW	1550													
11.5/80 - 15.3	9.00	-	290	867	380	2540	STD	14	TT	126 A8	139 A8	km/h - bar	4.80	
												10 FR	3400	
												25 FR	2890	
												30 FR	2720	
												40 FR	2430	
												10 DW	2380	
												25 DW	2025	
												30 DW	1905	
40 DW	1700													
11.5/80 - 15.3	9.00	-	290	867	380	2540	STD	14	TL	126 A8	139 A8	km/h - bar	4.80	
												10 FR	3400	
												25 FR	2890	
												30 FR	2720	
												40 FR	2430	
												10 DW	2380	
												25 DW	2025	
												30 DW	1905	
40 DW	1700													
11.5/80 - 15.3	9.00	-	290	867	380	2540	SR	12	TL	123 A8	135 A8	km/h - bar	4.10	
												10 FR	3050	
												25 FR	2595	
												30 FR	2440	
												40 FR	2180	
												10 DW	2170	
												25 DW	1845	
												30 DW	1735	
40 DW	1550													
27 X 10 - 15.3	9.00	-	260	695	317	2071	STD	8	TL	95 A8	107 A8	km/h - bar	3.10	
												10 FR	1365	
												25 FR	1160	
												30 FR	1090	
												40 FR	975	
												10 DW	965	
												25 DW	820	
												30 DW	775	
40 DW	690													

Technologies



Heavy Duty



Reinforced Carcass



Aramid Belted

Performance



Cut and Chip Resistance



Durability



Self-Cleaning



Stability



Traction

STD: Standard - SR: Stubble Resistant

Ø 15.3"	Tire size	RIM		S.W. (mm)	O.D. (mm)	SLR (mm)	RC (mm)	Version	PR	Type	LI/SS Drive Wheel	LI/SS Free Rolling	Load capacity (kg/tire)	
		Rec.	Alt.										km/h - bar	
27 X 10 - 15.3	27 X 10 - 15.3	9.00	-	260	695	317	2071	STD	8	TT	95 A8	107 A8	3.10	
													10 FR	1365
													25 FR	1160
													30 FR	1090
													40 FR	975
													10 DW	965
													25 DW	820
													30 DW	775
40 DW	690													
Ø 16"	270/75 - 16	9.00	-	250	810	-	-	STD	-	TL	111 A8	123 A8	3.90	
													10 FR	2170
													25 FR	1845
													30 FR	1735
													40 FR	1550
													10 DW	1525
													25 DW	1295
													30 DW	1220
	40 DW	1090												
	4.00 - 16	3.00 D	2.50 C	110	628	296	1935	STD	4	TT	66 A8	78 A8		2.80
													10 FR	595
													25 FR	505
													30 FR	475
													40 FR	425
													10 DW	420
													25 DW	355
30 DW													335	
40 DW	300													
6.00 - 16	4.00 E	4.50 E; 4½ K	164	735	343	2190	STD	6	TT	83 A8	95 A8		2.80	
												10 FR	965	
												25 FR	820	
												30 FR	775	
												40 FR	690	
												10 DW	680	
												25 DW	575	
												30 DW	545	
40 DW	485													
6.00 - 16	4.00 E	4.50 E; 4½ K	164	735	343	2190	HD	6	TT	83 A8	95 A8		2.80	
												10 FR	965	
												25 FR	820	
												30 FR	775	
												40 FR	690	
												10 DW	680	
												25 DW	575	
												30 DW	545	
40 DW	485													

STD: Standard - HD: Heavy Duty

Technologies



Performance



Ø 16"	Tire size	RIM		S.W. (mm)	O.D. (mm)	SLR (mm)	RC (mm)	Version	PR	Type	LI/SS Drive Wheel	LI/SS Free Rolling	Load capacity (kg/tire)	
		Rec.	Alt.										km/h - bar	
6.00 - 16	4.00 E	4.50 E ; 4½ K	164	735	343	2190	HD	8	TT	91 A8	103 A8	4.00		
												10 FR	1225	
												25 FR	1040	
												30 FR	980	
												40 FR	875	
												10 DW	860	
												25 DW	730	
												30 DW	690	
40 DW	615													
7.50 - 16	5.50 F	4.50 E ; 5.00 F ; 4.00 E ; 5 K ; 6 LB ; 6.00 F	209	803	372	2475	STD	8	TL	99 A8	112 A8	3.20		
												10 FR	1570	
												25 FR	1335	
												30 FR	1255	
												40 FR	1120	
												10 DW	1085	
												25 DW	920	
												30 DW	870	
40 DW	775													
7.50 - 16	5.50 F	4.50 E ; 5.00 F ; 4.00 E ; 5 K ; 6 LB ; 6.00 F	209	803	372	2475	STD	6	TT	92 A8	104 A8	2.30		
												10 FR	1260	
												25 FR	1070	
												30 FR	1010	
												40 FR	900	
												10 DW	880	
												25 DW	750	
												30 DW	705	
40 DW	630													
7.50 - 16	5.50 F	4.50 E ; 5.00 F ; 4.00 E ; 5 K ; 6 LB ; 6.00 F	209	803	372	2475	STD	8	TT	99 A8	112 A8	3.20		
												10 FR	1570	
												25 FR	1335	
												30 FR	1255	
												40 FR	1120	
												10 DW	1085	
												25 DW	920	
												30 DW	870	
40 DW	775													
7.50 - 16	5.50 F	4.50 E ; 5.00 F ; 4.00 E ; 5 K ; 6 LB ; 6.00 F	209	803	372	2475	HD	8	TT	99 A8	112 A8	3.20		
												10 FR	1570	
												25 FR	1335	
												30 FR	1255	
												40 FR	1120	
												10 DW	1085	
												25 DW	920	
												30 DW	870	
40 DW	775													

STD: Standard - HD: Heavy Duty

Technologies



Heavy Duty



Reinforced Carcass



Aramid Belted

Performance



Cut and Chip Resistance



Durability



Self-Cleaning



Stability



Traction

Ø 16"	Tire size	RIM		S.W. (mm)	O.D. (mm)	SLR (mm)	RC (mm)	Version	PR	Type	LI/SS Drive Wheel	LI/SS Free Rolling	Load capacity (kg/tire)	
		Rec.	Alt.										km/h - bar	
9.0/70 - 16 (230/70 - 16)	W 7	-	222	760	355	2285	STD	10	TL	106 A8	119 A8	4.40		
												10 FR	1905	
												25 FR	1620	
												30 FR	1525	
												40 FR	1360	
												10 DW	1330	
												25 DW	1130	
												30 DW	1065	
40 DW	950													
Ø 17"	15.0/55 - 17	13.00	13	380	890	395	2608	STD	10	TL	122 A8	134 A8	2.60	
													10 FR	2970
													25 FR	2525
													30 FR	2375
													40 FR	2120
													10 DW	2100
													25 DW	1785
													30 DW	1680
40 DW	1500													
15.0/55 - 17	13.00	13	380	890	395	2608	STD	14	TL	128 A8	141 A8	3.60		
												10 FR	3605	
												25 FR	3065	
												30 FR	2885	
												40 FR	2575	
												10 DW	2520	
												25 DW	2140	
												30 DW	2010	
40 DW	1800													
19.0/45 - 17	16.00	-	465	865	389	2578	STD	14	TL	131 A8	144 A8	2.80		
												10 FR	3920	
												25 FR	3330	
												30 FR	3135	
												40 FR	2800	
												10 DW	2730	
												25 DW	2320	
												30 DW	2185	
40 DW	1950													
19.0/45 - 17	16.00	-	465	865	389	2578	STD	16	TL	134 A8	147 A8	3.10		
												10 FR	4305	
												25 FR	3660	
												30 FR	3445	
												40 FR	3075	
												10 DW	2970	
												25 DW	2525	
												30 DW	2375	
40 DW	2120													

STD: Standard

Technologies



Heavy Duty



Reinforced Carcass



Aramid Belted

Performance



Cut and Chip Resistance



Durability



Self-Cleaning



Stability



Traction

Ø 17"	Tire size	RIM		S.W. (mm)	O.D. (mm)	SLR (mm)	RC (mm)	Version	PR	Type	LI/SS Drive Wheel	LI/SS Free Rolling	Load capacity (kg/tire)	
		Rec.	Alt.										km/h - bar	
420/55 - 17	13.00	-	430	910	407	2712	STD	14	TL	129 A8	142 A8	3.00		
												10 FR	3710	
												25 FR	3155	
												30 FR	2970	
												40 FR	2650	
												10 DW	2590	
												25 DW	2200	
30 DW	2070													
40 DW	1850													
420/55 - 17	13.00	-	430	910	407	2712	STD	16	TL	133 A8	145 A8	3.50		
												10 FR	4060	
												25 FR	3450	
												30 FR	3250	
												40 FR	2900	
												10 DW	2885	
												25 DW	2450	
30 DW	2305													
40 DW	2060													
Ø 18"	Tire size	RIM		S.W. (mm)	O.D. (mm)	SLR (mm)	RC (mm)	Version	PR	Type	LI/SS Drive Wheel	LI/SS Free Rolling	Load capacity (kg/tire)	
		Rec.	Alt.										km/h - bar	
7.50 - 18	5.50 F	4.50 E ; 6.00 F ; 5.00 F	209	854	407	2649	STD	6	TT	94 A8	106 A8	2.30		
												10 FR	1330	
												25 FR	1130	
												30 FR	1065	
												40 FR	950	
												10 DW	940	
												25 DW	795	
30 DW	750													
40 DW	670													
7.50 - 18	5.50 F	4.50 E ; 6.00 F ; 5.00 F	209	854	407	2649	STD	8	TT	101 A8	114 A8	3.10		
												10 FR	1650	
												25 FR	1405	
												30 FR	1320	
												40 FR	1180	
												10 DW	1155	
												25 DW	980	
30 DW	925													
40 DW	825													
7.50 - 18	5.50 F	4.50 E ; 6.00 F ; 5.00 F	209	854	407	2649	STD	12	TT	111 A8	122 A8	5.10		
												10 FR	2100	
												25 FR	1785	
												30 FR	1680	
												40 FR	1500	
												10 DW	1525	
												25 DW	1295	
30 DW	1220													
40 DW	1090													

STD: Standard

Technologies



Heavy Duty



Reinforced Carcass



Aramid Belted

Performance



Cut and Chip Resistance



Durability



Self-Cleaning



Stability



Traction

Ø 18"	Tire size	RIM		S.W. (mm)	O.D. (mm)	SLR (mm)	RC (mm)	Version	PR	Type	LI/SS Drive Wheel	LI/SS Free Rolling	Load capacity (kg/tire)	
		Rec.	Alt.										km/h - bar	
10.5/80 - 18	W 9	9 ; W 8	274	907	427	2790	STD	10	TL	119 A8	131 A8	3.70		
												10 FR	2730	
												25 FR	2320	
												30 FR	2185	
												40 FR	1950	
												10 DW	1905	
												25 DW	1620	
												30 DW	1525	
40 DW	1360													
12.5/80 - 18	W 9	9 ; 11	308	987	438	2892	STD	12	TL	129 A8	142 A8	3.70		
												10 FR	3710	
												25 FR	3155	
												30 FR	2970	
												40 FR	2650	
												10 DW	2590	
												25 DW	2200	
												30 DW	2070	
40 DW	1850													
12.5/80 - 18	W 9	9 ; 11	308	987	438	2892	STD	16	TL	135 A8	148 A8	4.90		
												10 FR	4410	
												25 FR	3750	
												30 FR	3530	
												40 FR	3150	
												10 DW	3050	
												25 DW	2595	
												30 DW	2440	
40 DW	2180													
12.5/80 - 18	W 9	9 ; 11	308	987	438	2892	STD	18	TL	138 A8	150 A8	5.50		
												10 FR	4690	
												25 FR	3985	
												30 FR	3750	
												40 FR	3350	
												10 DW	3305	
												25 DW	2810	
												30 DW	2645	
40 DW	2360													
12.5/80 - 18	W 9	9 ; 11	308	987	438	2892	SPL	12	TL	129 A8	142 A8	3.70		
												10 FR	3710	
												25 FR	3155	
												30 FR	2970	
												40 FR	2650	
												10 DW	2590	
												25 DW	2200	
												30 DW	2070	
40 DW	1850													

STD: Standard - SPL: Special

Technologies



Heavy Duty



Reinforced Carcass



Aramid Belted

Performance



Cut and Chip Resistance



Durability



Self-Cleaning



Stability



Traction

Ø 20"	Tire size	RIM		S.W. (mm)	O.D. (mm)	SLR (mm)	RC (mm)	Version	PR	Type	LI/SS Drive Wheel	LI/SS Free Rolling	Load capacity (kg/tire)	
		Rec.	Alt.										km/h - bar	
7.50 - 20	5.50 F	4.50 E ; 6.00 F ; 5.00 F	209	904	422	2695	STD	8	TT	103 A8	116 A8		km/h - bar	3.20
													10 FR	1750
													25 FR	1490
													30 FR	1400
													40 FR	1250
													10 DW	1225
													25 DW	1040
													30 DW	980
40 DW	875													
16.0/70 - 20	13	12 SDC ; 14 ; 13 SDC	418	1097	487	3214	STD	14	TL	142 A8	154 A8		km/h - bar	3.50
													10 FR	5250
													25 FR	4465
													30 FR	4200
													40 FR	3750
													10 DW	3710
													25 DW	3155
													30 DW	2970
40 DW	2650													
16.0/70 - 20	13	12 SDC ; 14 ; 13 SDC	418	1097	487	3214	STD	16	TL	144 A8	156 A8		km/h - bar	4.00
													10 FR	5600
													25 FR	4760
													30 FR	4480
													40 FR	4000
													10 DW	3920
													25 DW	3330
													30 DW	3135
40 DW	2800													
16.0/70 - 20	13	12 SDC ; 14 ; 13 SDC	418	1097	487	3214	STD	10	TL	135 A8	147 A8		km/h - bar	2.50
													10 FR	4305
													25 FR	3660
													30 FR	3445
													40 FR	3075
													10 DW	3050
													25 DW	2595
													30 DW	2440
40 DW	2180													
16.0/70 - 20	13	12 SDC ; 14 ; 13 SDC	418	1097	487	3214	STD	12	TL	139 A8	151 A8		km/h - bar	3.00
													10 FR	4830
													25 FR	4105
													30 FR	3865
													40 FR	3450
													10 DW	3400
													25 DW	2890
													30 DW	2720
40 DW	2430													
400/70 - 20	13	12 SDC ; 14 ; 13 SDC	408	1097	487	3214	IND	-	TL	149 A8			km/h - bar	4.00
													10	4060
													25	3445
													30	3380
40	3250													

Technologies



Heavy Duty



Reinforced Carcass



Aramid Belted

Performance



Cut and Chip Resistance



Durability



Self-Cleaning



Stability



Traction

Ø 24"	Tire size	RIM		S.W. (mm)	O.D. (mm)	SLR (mm)	RC (mm)	Version	PR	Type	LI/SS Drive Wheel	LI/SS Free Rolling	Load capacity (kg/tire)	
		Rec.	Alt.										km/h - bar	
15.5/80 - 24	W 12	W 13 ; W 14 L	384	1262	570	3875	STD	14	TL	148 A8	160 A8		10 FR	6300
													25 FR	5355
													30 FR	5040
													40 FR	4500
													10 DW	4410
													25 DW	3750
													30 DW	3530
													40 DW	3150
15.5/80 - 24	W 12	W 13 ; W 14 L	384	1262	570	3875	STD	16	TL	151 A8	163 A8		10 FR	6825
													25 FR	5800
													30 FR	5460
													40 FR	4875
													10 DW	4830
													25 DW	4105
													30 DW	3865
													40 DW	3450
15.5/80 - 24	W 12	W 13 ; W 14 L	384	1262	570	3875	STD	10	TL	142 A8	154 A8		10 FR	5250
													25 FR	4465
													30 FR	4200
													40 FR	3750
													10 DW	3710
													25 DW	3155
													30 DW	2970
													40 DW	2650
15.5/80 - 24	W 12	W 13 ; W 14 L	384	1262	570	3875	STD	12	TL	145 A8	157 A8		10 FR	5775
													25 FR	4910
													30 FR	4620
													40 FR	4125
													10 DW	4060
													25 DW	3450
													30 DW	3250
													40 DW	2900
15.5/80 - 24	W 12	W 13 ; W 14 L	384	1262	570	3875	SPL	14	TL	148 A8	160 A8		10 FR	6300
													25 FR	5355
													30 FR	5040
													40 FR	4500
													10 DW	4410
													25 DW	3750
													30 DW	3530
													40 DW	3150

STD: Standard - SPL: Special

Technologies



Heavy Duty



Reinforced Carcass



Aramid Belted

Performance



Cut and Chip Resistance



Durability



Self-Cleaning



Stability



Traction

Ø 24"	Tire size	RIM		S.W. (mm)	O.D. (mm)	SLR (mm)	RC (mm)	Version	PR	Type	LI/SS Drive Wheel	LI/SS Free Rolling	Load capacity (kg/tire)	
		Rec.	Alt.										km/h - bar	
16.5/85 - 24	W 13	W 14 L; W 15 L	415	1325	591	3837	STD	16	TT	155 A8	168 A8	3.80		
												10 FR	7840	
												25 FR	6665	
												30 FR	6270	
												40 FR	5600	
												10 DW	5425	
												25 DW	4610	
												30 DW	4340	
40 DW	3875													
16.5/85 - 24	W 13	W 14 L; W 15 L	415	1325	591	3837	STD	16	TL	155 A8	168 A8	3.80		
												10 FR	7840	
												25 FR	6665	
												30 FR	6270	
												40 FR	5600	
												10 DW	5425	
												25 DW	4610	
												30 DW	4340	
40 DW	3875													
16.5/85 - 24	W 13	W 14 L; W 15 L	415	1325	591	3837	STD	10	TL	146 A8	158 A8	2.40		
												10 FR	5950	
												25 FR	5060	
												30 FR	4760	
												40 FR	4250	
												10 DW	4200	
												25 DW	3570	
												30 DW	3360	
40 DW	3000													
16.5/85 - 24	W 13	W 14 L; W 15 L	415	1325	591	3837	STD	12	TL	151 A8	163 A8	2.80		
												10 FR	6825	
												25 FR	5800	
												30 FR	5460	
												40 FR	4875	
												10 DW	4830	
												25 DW	4105	
												30 DW	3865	
40 DW	3450													
400/80 - 24	W 13	W 12 ; W 14 L	394	1262	566	3655	IND	-	TL	156 A8	3.80			
											10	5000		
											25	4240		
											30	4160		
40	4000													
400/80 - 24	W 13	W 12 ; W 14 L	394	1262	566	3655	IND	-	TL	162 A8	5.00			
											10	5940		
											25	5035		
											30	4940		
40	4750													

STD: Standard - IND: Industrial

Technologies



Heavy Duty



Reinforced Carcass



Aramid Belted

Performance



Cut and Chip Resistance



Durability



Self-Cleaning



Stability



Traction



MULTIUSE

Bias



AT 603

AT 603 is a bias agro-industrial tire for implement machinery and backhoe loaders. AT 603 has been engineered to ensure great durability and traction on drive wheels providing best performance on every surface as well as excellent self-cleaning properties. The AT 603 "special" version has a reinforced casing, while the "HD" version offers improved cut and chip resistance.

Ø 18"	Tire size	RIM		S.W. (mm)	O.D. (mm)	SLR (mm)	RC (mm)	Version	PR	Type	LI/SS Drive Wheel	LI/SS Free Rolling	Load capacity (kg/tire)	
		Rec.	Alt.										km/h - bar	3.70
10.5/80 - 18	W 9	W 8 ; 9	274	907	422	2727	STD	10	TL	119 A8	131 A8	10 FR	2730	
												25 FR	2320	
												30 FR	2185	
												40 FR	1950	
												10 DW	1905	
												25 DW	1620	
												30 DW	1525	
												40 DW	1360	
												10.5/80 - 18	W 9	W 8 ; 9
25 FR	2320													
30 FR	2185													
40 FR	1950													
10 DW	1905													
25 DW	1620													
30 DW	1525													
40 DW	1360													
10.5/80 - 18	W 9	W 8 ; 9	274	907	422	2727	SPL	10	TL	119 A8	131 A8			
												25 FR	2320	
												30 FR	2185	
												40 FR	1950	
												10 DW	1905	
												25 DW	1620	
												30 DW	1525	
												40 DW	1360	
												12.5/80 - 18	W 9	11
25 FR	3155													
30 FR	2970													
40 FR	2650													
10 DW	2590													
25 DW	2200													
30 DW	2070													
40 DW	1850													

STD: Standard - SPL: Special - HD: Heavy Duty

Technologies



Heavy Duty



Reinforced Carcass

Performance



Cut and Chip Resistance



Durability



Self-Cleaning



Traction





MULTIUSE

AT 603

Ø 18"	Tire size	RIM		S.W. (mm)	O.D. (mm)	SLR (mm)	RC (mm)	Version	PR	Type	LI/SS Drive Wheel	LI/SS Free Rolling	Load capacity (kg/tire)														
		Rec.	Alt.										km/h - bar	2.50	4.00	2.50											
12.5/80 - 18	W 9	11	308	1000	448	3027	STD	16	TL	135 A8	148 A8	10 FR	4410	25 FR	3750	30 FR	3530	40 FR	3150	10 DW	3050	25 DW	2595	30 DW	2440	40 DW	2180
												10 FR	4690	25 FR	3985	30 FR	3750	40 FR	3350	10 DW	3305	25 DW	2810	30 DW	2645	40 DW	2360
												10 FR	3710	25 FR	3155	30 FR	2970	40 FR	2650	10 DW	2590	25 DW	2200	30 DW	2070	40 DW	1850
												50	3250	10	-	5600	40	-	2650								
												50	3250	10	-	5600	40	-	2650								
												10	-	5600	40	-	2650										
												10	-	5600	40	-	2650										
												40	-	5600	40	-	2650										
												40	-	5600	40	-	2650										
												40	-	5600	40	-	2650										

Technologies



Heavy Duty



Reinforced Carcass

Performance



Cut and Chip Resistance



Durability



Self-Cleaning



Traction

STD: Standard - SPL: Special





MULTIUSE

Bias



AT 621 (R-4)

AT 621 is suitable for backhoe loaders and compact loaders in all digging and loading operations in agriculture. The AT 621 tire features an extra deep tread which ensures great cut and chip resistance and higher durability. In addition, this BKT tire ensures great durability and self cleaning properties. AT 621 is available in several versions to meet the most differing user requirements.

Ø 15"	Tire size	RIM		S.W. (mm)	O.D. (mm)	SLR (mm)	RC (mm)	Version	PR	Type	LI/SS Drive Wheel	LI/SS Free Rolling	Load capacity (kg/tire)	
		Rec.	Alt.										km/h - bar	
33 X 12.5 - 15	10.00 F SDC	-	318	851	385	2493	STD	8	TT	-	-	10	2130	
												3.25		
Ø 15.3"	10.0/75 - 15.3	9.0	-	267	780	373	2385	STD	10	TL	127A6	10	5.25	
												30	1750	
Ø 16"	9.00 - 16	6.50 H	6.00 G	260	925	-	-	IND	16	TT	137A6	10	7.25	
												30	2300	
	12.5/70 - 16	10 LB	-	315	855	385	2584	STD	14	TL	-	-	10	4.4
													2240	
12.5/70 - 16	10 LB	-	315	855	385	2584	STD	14	TT	-	-	10	4.4	
												2240		
12.5/70 - 16	10 LB	-	315	855	385	2584	STD	8	TL	-	-	10	2.60	
												1645		
Ø 18"	12.5/80 - 18	W 9	11.0	308	987	434	2916	STD	12	TT	129 A8	142 A8	10	3.70
													10 FR	3710
													25 FR	3155
													30 FR	2970
													40 FR	2650
													10 DW	2590
													25 DW	2200
													30 DW	2070
40 DW	1850													

Performance



STD: Standard - IND: Industrial



Ø 18"	Tire size	RIM		S.W. (mm)	O.D. (mm)	SLR (mm)	RC (mm)	Version	PR	Type	LI/SS Drive Wheel	LI/SS Free Rolling	Load capacity (kg/tire)	
		Rec.	Alt.										km/h - bar	
12.5/80 - 18	W 9	11.0	308	987	434	2916	STD	16	TL	135 A8	148 A8	km/h - bar	4.90	
												10 FR	4410	
												25 FR	3750	
												30 FR	3530	
												40 FR	3150	
												10 DW	3050	
												25 DW	2595	
												30 DW	2440	
												40 DW	2180	
												km/h - bar	3.70	
10 FR	3710													
25 FR	3155													
30 FR	2970													
40 FR	2650													
10 DW	2590													
25 DW	2200													
30 DW	2070													
40 DW	1850													
12.5/80 - 18	W 9	11.0	308	987	434	2916	STD	16	TT	135 A8	148 A8	km/h - bar	4.90	
												10 FR	4410	
												25 FR	3750	
												30 FR	3530	
												40 FR	3150	
												10 DW	3050	
												25 DW	2595	
												30 DW	2440	
												40 DW	2180	
												12.5/80 - 18	W 9	11.0
10 FR	4410													
25 FR	3750													
30 FR	3530													
40 FR	3150													
10 DW	3050													
25 DW	2595													
30 DW	2440													
40 DW	2180													
12.5/80 - 18	W 9	11.0	308	987	434	2916	SPL	12	TL	129 A8	142 A8			
												10 FR	3710	
												25 FR	3155	
												30 FR	2970	
												40 FR	2650	
												10 DW	2590	
												25 DW	2200	
												30 DW	2070	
												40 DW	1850	
												15.5/60 - 18	W 13	-
10	2430													
15.5/60 - 18	W 13	-	394	940	428	2871	STD	12	TL	141 A2	km/h - bar	3.00		
											10	2575		

Performance



Cut and Chip Resistance



Durability



Self-Cleaning



Traction

STD: Standard - SPL: Special - IND HD: Industrial HD



Ø 18"	Tire size	RIM		S.W. (mm)	O.D. (mm)	SLR (mm)	RC (mm)	Version	PR	Type	LI/SS Drive Wheel	LI/SS Free Rolling	Load capacity (kg/tire)	
		Rec.	Alt.										km/h - bar	
	15.5/70 - 18 (400/70 - 18)	W 13	-	400	1030	474	3111	STD	10	TL	-	-	10	2700
													km/h - bar	2.60
													10	2700
													0 (STATIONARY)	2700
													km/h - bar	6.90
													10	5150
													0 (STATIONARY)	6700
													km/h - bar	3.50
													40 FR	3350
													40 DW	2300
													km/h - bar	2.40
													10	3195
													km/h - bar	4.00
													50	3550
													10	5600
													km/h - bar	4.00
													40	3250
													km/h - bar	3.00
													10	3690
													km/h - bar	2.60
													40	3250
													km/h - bar	1.70
													40	2430
													km/h - bar	2.30
													40	3450

Performance



STD: Standard - IND: Industrial



MULTIUSE

AT 621 (R-4)

Ø 26"	Tire size	RIM		S.W. (mm)	O.D. (mm)	SLR (mm)	RC (mm)	Version	PR	Type	LI/SS Drive Wheel	LI/SS Free Rolling	Load capacity (kg/tire)	
		Rec.	Alt.										km/h - bar	
18.4 - 26	DW 16 L DW 15 L	480	1425	649	4288	STD	12	TL	156A8	40	2.50	4000		
Ø 28"	16.9 - 28	DW 15 L DW 14 L	450	1410	639	4199	IND	14	TL	154A8	40	2.90	3750	
16.9 - 28	DW 15 L DW 14 L	450	1410	639	4199	IND	12	TT	152A8	40	2.60	3550		
16.9 - 28	DW 15 L DW 14 L	450	1410	639	4199	IND	12	TL	152A8	40	2.60	3550		
16.9 - 28	DW 15 L DW 14 L	450	1410	639	4199	IND	14	TL	154A8	40	2.90	3750		
Ø 30"	16.9 - 30	DW 15 L DW 14 L	450	1460	670	4398	IND	12	TL	153A8	40	2.60	3650	

Performance



Cut and Chip Resistance



Durability



Self-Cleaning



Traction

STD: Standard - IND: Industrial





MULTIUSE

Bias



MP 567

MP 567 is an agro-industrial tire suitable for field and road transport and municipality/ maintenance operations. It is the perfect tire for telehandlers and implement machinery. The MP 567 tire provides good traction in all the weather conditions as well as excellent self-cleaning properties. This tire ensures a comfortable driving experience, together with a longer service life.

Ø 15"	Tire size	RIM		S.W. (mm)	O.D. (mm)	SLR (mm)	RC (mm)	Version	PR	Type	LI/SS Drive Wheel	LI/SS Free Rolling	Load capacity (kg/tire)	
		Rec.	Alt.										km/h - bar	
11.5/80 - 15	8 LB	-	290	875	-	-	IMP	12	TL	123 A8	135 A8	km/h - bar	4.10	
												40 FR	2180	
												40 DW	1550	
Ø 15.3"	10.0/75 - 15.3	9.0	-	258	774	365	2401	IMP	18	TL	123 A8	135 A8	km/h - bar	7.10
													40 FR	2180
													40 DW	1550
10.0/75 - 15.3	9.0	-	258	774	365	2401	IMP	10	TL	111 A8	123 A8	km/h - bar	3.90	
												40 FR	1550	
												40 DW	1090	
10.0/75 - 15.3	9.0	-	258	774	365	2401	IMP	12	TL	114 A8	126 A8	km/h - bar	4.70	
												40 FR	1700	
												40 DW	1180	
10.0/75 - 15.3	9.0	-	258	774	365	2401	IMP	14	TL	118 A8	130 A8	km/h - bar	5.50	
												40 FR	1900	
												40 DW	1320	
11.5/80 - 15.3	9.0	-	292	868	393	2578	IMP	18	TL	130 A8	143 A8	km/h - bar	6.00	
												40 FR	2725	
												40 DW	1900	
11.5/80 - 15.3	9.0	-	292	868	393	2578	IMP	10	TL	119 A8	131 A8	km/h - bar	3.40	
												40 FR	1950	
												40 DW	1360	

Performance



IMP: Implement



Ø 15.3"	Tire size	RIM		S.W. (mm)	O.D. (mm)	SLR (mm)	RC (mm)	Version	PR	Type	LI/SS Drive Wheel	LI/SS Free Rolling	Load capacity (kg/tire)	
		Rec.	Alt.										km/h - bar	
	11.5/80 - 15.3	9.0	-	292	868	393	2578	IMP	14	TL	126 A8	139 A8	40 FR	2430
													40 DW	1700
Ø 18"	10.5 - 18	9	9 SDC	273	905	415	2768	STD	10	TT	-	-	km/h - bar	3.75
													90	1700
													40	1955
	10.5 - 18	9	9 SDC	273	905	415	2768	STD	10	TL	-	-	km/h - bar	3.75
													90	1700
													40	1955
	10.5 - 18	9	9 SDC	273	905	415	2768	STD	12	TL	-	-	km/h - bar	4.50
													90	1900
													40	2190
	10.5 - 18	9	9 SDC	273	905	415	2768	SPL	12	TL	-	-	km/h - bar	4.50
													90	1900
													40	2190
	12.0/75 - 18 (300/75 - 18)	W 9	9 ; 11	298	915	426	2723	IMP	12	TL	126 A8	139 A8	km/h - bar	4.00
													40 FR	2430
													40 DW	1700
	12.5 - 18	11	12 SDC	325	990	450	2940	STD	10	TT	-	-	km/h - bar	3.00
													90	1800
													40	2070
	12.5 - 18	11	12 SDC	325	990	450	2940	STD	10	TL	-	-	km/h - bar	3.00
													90	1800
													40	2070
	12.5 - 18	11	12 SDC	325	990	450	2940	STD	12	TT	-	-	km/h - bar	3.50
													90	1950
													40	2245

Performance



Comfort



Durability



Self-Cleaning



Traction

STD: Standard - IMP: Implement - SPL: Special



Ø 18"	Tire size	RIM		S.W. (mm)	O.D. (mm)	SLR (mm)	RC (mm)	Version	PR	Type	LI/SS Drive Wheel	LI/SS Free Rolling	Load capacity (kg/tire)	
		Rec.	Alt.										km/h - bar	
Ø 18"	12.5 - 18	11	12 SDC	325	990	466	3024	STD	12	TL	-	-	90	1950
													40	2245
													km/h - bar	3.50
	12.5 - 18	11	12 SDC	325	990	450	2940	STD	16	TL	-	-	90	2250
													40	2585
													km/h - bar	4.50
Ø 19.5"	18 - 19.5 IND	14.00	-	460	1104	498	3280	STD	16	TL	160 B / 162 A8		90	6.00
													50	4500
													40	4700
	18 - 19.5 IND	14.00	-	460	1104	498	3280	STD	18	TL	165 B / 167 A8		90	7.25
													50	5150
													40	5460
Ø 20"	10.5 - 20	9	9 SDC	270	955	445	2880	STD	10	TT	-		90	3.75
													40	1800
													40	2070
	10.5 - 20	9	9 SDC	270	955	445	2880	STD	10	TL	-		90	3.75
													40	1800
													40	2070
	12.5 - 20	11.0	12 SDC	325	1040	490	3142	STD	10	TT	-		90	3.00
													40	1850
													40	2130
	12.5 - 20	11.0	12 SDC	325	1040	490	3142	STD	10	TL	-		90	3.00
													40	1850
													40	2130
	12.5 - 20	11.0	12 SDC	325	1040	490	3142	STD	12	TT	-		90	3.50
													40	2000
													40	2300

Performance



Comfort



Durability



Self-Cleaning



Traction

STD: Standard



Ø 20"	Tire size	RIM		S.W. (mm)	O.D. (mm)	SLR (mm)	RC (mm)	Version	PR	Type	LI/SS	Load capacity (kg/tire)	
		Rec.	Alt.									km/h - bar	
12.5 - 20	11.0	12 SDC	325	1040	490	3142	STD	12	TL	-		90	2000
												40	2300
12.5 - 20	11.0	12 SDC	325	1040	490	3142	STD	16	TL	-		90	2300
												40	2750
12.5 - 20	11.0	12 SDC	325	1040	490	3142	HD	12	TL	-		90	2000
												40	2300
14.5 - 20	11	12 SDC	360	1116	495	3315	STD	10	TL	-		90	2000
												40	2300
14.5 - 20	11	12 SDC	360	1116	495	3315	STD	12	TL	-		90	2240
												40	2580
14.5 - 20	11	12 SDC	360	1116	495	3315	STD	14	TL	-		90	2430
												40	2790
14.5 - 20	11	12 SDC	360	1116	495	3315	STD	16	TL	-		90	2575
												40	2960
14.5 - 20	11	12 SDC	360	1116	495	3315	STD	18	TL	-		90	2725
												40	3135
14.5 - 20	11	12 SDC	360	1116	495	3315	HD	14	TL	-		90	2430
												40	2790

Performance



Comfort



Durability





Self-Cleaning



Traction

STD: Standard - HD: Heavy Duty



Ø 20"	Tire size	RIM		S.W. (mm)	O.D. (mm)	SLR (mm)	RC (mm)	Version	PR	Type	LI/SS	Load capacity (kg/tire)	
		Rec.	Alt.									km/h - bar	
													
16.0/70 - 20 (405/70 - 20)	13 SDC	12	405	1128	490	3350	STD	14	TL	-		3.50	
												90	2900
												40	3340
16.0/70 - 20 (405/70 - 20)	13 SDC	12	405	1128	490	3350	STD	14	TT	-		3.50	
												90	2900
												40	3340

STD: Standard

Performance



Comfort



Durability



Self-Cleaning



Traction





MULTIUSE

Bias



MP 570

MP 570 is an agro-industrial tire, which is suitable for excavators and backhoe loaders. This tire provides good traction and durability, as well as excellent self-cleaning properties in all operating conditions.

Ø 18"	Tire size	RIM		S.W. (mm)	O.D. (mm)	SLR (mm)	RC (mm)	Version	PR	Type	LI/SS	Load capacity (kg/tire)		
		Rec.	Alt.									km/h - bar		
12.5 - 18	11	12 SDC	308	990	450	2950	STD	12	TL	-		3.50		
												80	2030	
												50	2180	
12.5 - 18	11	12 SDC	308	990	450	2950	STD	10	TL	-		3.00		
												80	1930	
												50	2000	
Ø 20"	12.5 - 20	11	12 SDC	335	1050	480	3130	STD	10	TL	-		3.00	
													80	1850
													50	2065
12.5 - 20	11	12 SDC	335	1050	480	3130	STD	12	TL	-		3.50		
												80	2060	
												50	2300	
14.5 - 20	11	12 SDC	360	1116	505	3325	STD	12	TL	-		3.00		
												65	2430	
												50	2500	

Performance



Durability



Self-Cleaning



Traction

STD: Standard



MULTIUSE

Bias



MP 585

MP 585 is an agro-industrial tire, which is suitable for multi-purpose vehicles in municipality/maintenance applications. This tire is specially engineered with a block pattern that offers maximum stability and durability in the most difficult working conditions, also at high speeds.

Ø 20"	Tire size	RIM		S.W. (mm)	O.D. (mm)	SLR (mm)	RC (mm)	Version	PR	Type	LI/SS	Load capacity (kg/tire)	
		Rec.	Alt.									km/h - bar	
	6.50 - 20	5.50 F	4.00 E ; 5.00 F	200	875	-	-	STD	10	TT	106 A6	30	5.50 950
	10.5 - 20	9	9 SDC	273	970	455	2890	STD	10	TL	-	3.75 90	1800
	12.5 - 20	11	12 SDC	335	1050	480	3130	STD	12	TL	-	3.50 90	2000
												50	2240

STD: Standard

Technologies



Performance



MULTIUSE

Bias



MP 590

MP 590 is an agro-industrial tire suitable for loading operations with telehandlers and forklifts. This tire provides good traction and excellent stability as well as increased durability.

Ø 22.5"	Tire size	RIM		S.W. (mm)	O.D. (mm)	SLR (mm)	RC (mm)	Version	PR	Type	LI/SS	Load capacity (kg/tire)	
		Rec.	Alt.									km/h - bar	
	18 - 22.5 (445/65 - 22.5)	14.0	-	480	1190	530	3534	STD	16	TL	-	40 DW 30 DW	5.50 4875 5450
	18 - 22.5 (445/65 - 22.5)	14.0	-	480	1190	530	3534	STD	20	TL	-	7.50 40 DW 30 DW	5800 6500

STD: Standard

Performance





MULTIUSE

Bias



MP 600

MP 600 is an agro-industrial tire, suitable for municipality/maintenance operations with telehandlers and implement machinery, providing a comfortable driving experience. This tire provides good traction and excellent self-cleaning properties along with an extended product life-cycle.

Ø 18"	Tire size	RIM		S.W. (mm)	O.D. (mm)	SLR (mm)	RC (mm)	Version	PR	Type	LI/SS Drive Wheel	Load capacity (kg/tire)	
		Rec.	Alt.									km/h - bar	
10.5 - 18	9	9 SDC	272	920	420	2740	STD	10	TL	-	-	km/h - bar	3.75
												40 DW	1950
												50 DW	1900
12.5 - 18	11	12 SDC	308	990	450	2950	STD	10	TL	-	-	km/h - bar	3.00
												40 DW	2060
												50 DW	2000
12.5 - 18	11	12 SDC	308	990	450	2950	STD	12	TL	-	-	km/h - bar	3.50
												40 DW	2300
												50 DW	2240
Ø 20"	400/70 - 20 (16.0/70 - 20)	13 SDC	12	405	1085	-	-	STD	14	TL	-	km/h - bar	4.00
												40 DW	3550
												50 DW	3250
Ø 24"	400/70 - 24 (16.0/70 - 24)	13 SDC	12	405	1185	545	3530	STD	14	TL	-	km/h - bar	3.50
												40 DW	3650
												50 DW	3550
400/70 - 24 (16.0/70 - 24)	13 SDC	12	405	1185	545	3530	STD	10	TL	-	-	km/h - bar	2.50
												40 DW	2975
												50 DW	2900
400/70 - 24 (16.0/70 - 24)	13 SDC	12	405	1185	545	3530	STD	18	TL	158 A8	-	km/h - bar	4.50
												40 DW	4250
												50 DW	4125
400/70 - 24 (16.0/70 - 24)	13 SDC	12	405	1185	545	3530	SPL	14	TL	-	-	km/h - bar	3.50
												40 DW	3650
												50 DW	3550

Performance



STD: Standard - SPL: Special



MULTIUSE

Bias



TR 459 (R-4)

TR 459 has been particularly designed for digging and loading operations as well as municipality and maintenance applications with tractors and backhoe loaders. It offers high stability and is available in two versions. The "special" version provides an extended tire life-cycle.

Ø 20"	Tire size	RIM		S.W. (mm)	O.D. (mm)	SLR (mm)	RC (mm)	Version	PR	Type	LI/SS	Load capacity (kg/tire)	
		Rec.	Alt.									km/h - bar	4.00
	400/70 - 20	13	12 SDC ; 13 SDC ; 14	404	1090	-	-	IND	-	TL	149 A8	40	3250
Ø 24"	14.9 - 24	DW 13	DW 12 ; DW 11 ; DW 13 L	390	1244	562	3657	IIND	8	TL	137 A8	40	2300
	14.9 - 24	DW 13	DW 12 ; DW 11 ; DW 13 L	390	1244	562	3657	IIND	12	TL	145 A8	40	2900
	16.9 - 24	DW 15 L	DW 14 L	440	1310	590	3850	IIND	8	TL	142 A8	40	2650
	16.9 - 24	DW 15 L	DW 14 L	440	1310	590	3850	IND	10	TL	145 A8	40	2900
	16.9 - 24	DW 15 L	DW 14 L	440	1310	590	3850	IND	12	TL	149 A8	40	3250
	17.5L - 24	DW 15 L	DW 14 L	445	1270	557	3825	IND	8	TL	139 A8	40	2430
	17.5L - 24	DW 15 L	DW 14 L	445	1270	557	3825	IND	10	TL	144 A8	40	2800
	17.5L - 24	DW 15 L	DW 14 L	445	1270	557	3825	IND	12	TL	148 A8	40	3150
	18.4 - 24	DW 16 L	DW 15 L	472	1375	610	4114	IND	12	TL	155 A8	40	3875

Performance



IND: Industrial



Ø 24"	Tire size	RIM		S.W. (mm)	O.D. (mm)	SLR (mm)	RC (mm)	Version	PR	Type	LI/SS	Load capacity (kg/tire)		
		Rec.	Alt.									km/h - bar		
Ø 24"	19.5L - 24	DW 16 L	-	490	1333	585	4031	IND	10	TL	147 A8	40	1.90	3075
	19.5L - 24	DW 16 L	-	490	1333	585	4031	IND	12	TL	151 A8	40	2.30	3450
	19.5L - 24	DW 16 L	-	490	1333	585	4031	IND SPL	12	TL	151 A8	40	2.30	3450
	21L - 24	DW 18 L	-	533	1378	605	3995	IND	12	TL	155 A8	40	2.20	3875
	21L - 24	DW 18 L	-	533	1378	605	3995	IND	14	TL	157 A8	40	2.50	4125
Ø 26"	18.4 - 26	DW 16 L	DW 15 L	472	1425	628	4346	IND	12	TL	156 A8	40	2.50	4000
	18.4 - 26	DW 16 L	DW 15 L	472	1425	628	4346	IND	14	TL	159 A8	40	2.90	4375
	18.4 - 26	DW 16 L	DW 15 L	472	1425	628	4346	IND	16	TL	162 A8	40	3.30	4750
Ø 28"	16.9 - 28	DW 15 L	DW 14 L	440	1410	640	4145	IND	8	TL	145 A8	40	1.90	2900
	16.9 - 28	DW 15 L	DW 14 L	440	1410	640	4145	IND	10	TL	148 A8	40	2.20	3150
	16.9 - 28	DW 15 L	DW 14 L	440	1410	640	4145	IND	12	TL	152 A8	40	2.60	3550
	18.4 - 28	DW 16 L	DW 15 L	472	1475	664	4495	IND	12	TL	157 A8	40	2.50	4125

Performance



IND: Industrial - IND SPL - Industrial Special

Ø 28"	Tire size	RIM		S.W. (mm)	O.D. (mm)	SLR (mm)	RC (mm)	Version	PR	Type	LI/SS	Load capacity (kg/tire)	
		Rec.	Alt.									km/h - bar	
	21L - 28	DW 18 A	-	535	1480	-	-	IND	12	TL	157 A8	40	4125
												40	2.20

Ø 30"	Tire size	DW 15 L	DW 14 L	440	1470	657	4484	IND	12	TL	153 A8	Load capacity (kg/tire)	
												km/h - bar	
	16.9 - 30											40	3650
												40	2.70

Performance



Stability



Traction

IND: Industrial





MULTIUSE

Bias



TR 461 (R-4)

TR 461 is a BKT pattern suitable for municipality and maintenance applications with tractors as well as for loading operations with telehandlers. The sidewall protection features particular resistance against cuts and bruises providing a longer life even on hard surfaces in addition to excellent stability.

Ø 18"	Tire size	RIM		S.W. (mm)	O.D. (mm)	SLR (mm)	RC (mm)	Version	PR	Type	LI/SS Drive Wheel	LI/SS Free Rolling	Load capacity (kg/tire)	
		Rec.	Alt.										km/h - bar	
12.5/80 - 18	W 9	11	305	987	435	2902	STD	12	TL	129 A8	142 A8	km/h - bar	3.70	
												10 FR	3710	
												25 FR	3155	
												30 FR	2970	
												40 FR	2650	
												10 DW	2590	
												25 DW	2200	
												30 DW	2070	
												40 DW	1850	
												12.5/80 - 18	W 9	11
10 FR	4690													
25 FR	3985													
30 FR	3750													
40 FR	3350													
10 DW	3305													
25 DW	2810													
30 DW	2645													
40 DW	2360													
Ø 24"	16.9 - 24	DW 15 L	DW 14 L	440	1280	566	3763	STD	14	TL	151 A8			
												40	3450	
												km/h - bar	2.30	
												40	3450	
19.5L - 24	DW 16 L	-	490	1310	578	3851	STD	12	TL	151 A8	km/h - bar	2.60		
											40	3750		
19.5L - 24	DW 16 L	-	490	1310	578	3851	STD	14	TL	154 A8	km/h - bar	2.50		
											40	4125		
21L - 24	DW 18 L	-	540	1385	607	4072	STD	14	TL	157 A8	km/h - bar	2.90		
											40	3750		
Ø 28"	16.9 - 28	DW 15 L	DW 14 L	440	1390	620	4087	STD	14	TL	154 A8	km/h - bar	4.00	
												40	6900	
Ø 34"	620/60 B 34	DW 20 B	-	615	1629	750	4930	HD	-	TL	175 A8	km/h - bar	4.00	
												40	6900	

Performance



STD: Standard - HD: Heavy Duty



MULTIUSE

 Bias



TR 463 (R-4)

TR 463 has been specially designed for backhoe loaders and industrial tractors. Made of a superior tread compound and featuring a strong nylon casing, this tire stands for best results in industrial and OTR applications, and on construction sites. TR 463 provides excellent traction for drive wheels.

Ø 24"	Tire size	RIM		S.W. (mm)	O.D. (mm)	SLR (mm)	RC (mm)	Version	PR	Type	LI/SS	Load capacity (kg/tire)	
		Rec.	Alt.									km/h - bar	2.60
	16.9 - 24	DW 15 L	DW 14 L	445	1300	584	3877	IND	12	TL	149 A8	40	3250
												km/h - bar	2.50
	18.4 - 26	DW 16 L	DW 15 L	480	1425	637	4215	IND	12	TL	156 A8	40	4000
												km/h - bar	2.60
	16.9 - 28	DW 15 L	DW 14 L	450	1405	636	4190	IND	12	TL	152 A8	40	3550

Performance



IND: Industrial



FRONT





TF 8181 (F-2)

TF 8181 is a field and road tire designed for 2WD tractors in soil tillage and haulage applications. This tire provides excellent steering performance.

Ø 15"	Tire size	RIM		S.W. (mm)	O.D. (mm)	SLR (mm)	RC (mm)	Version	PR	Type	LI/SS	Load capacity (kg/tire)	
		Rec.	Alt.									km/h - bar	3.40
4.00 - 15	3.00 D	4 J	112	605	287	1834	STD	4	TT	66 A6	30	300	
5.00 - 15	4.00 E	3.00 D ; 4 J ; 4½ J	142	655	307	1951	STD	4	TT	73 A6	km/h - bar	2.80	
											30	365	
5.00 - 15	4.00 E	3.00 D ; 4 J ; 4½ J	142	655	307	1951	STD	6	TT	82 A6	km/h - bar	3.70	
											30	475	
5.00 - 15	4.00 E	3.00 D ; 4 J ; 4½ J	142	655	307	1951	SPL	6	TT	82 A6	km/h - bar	3.70	
											30	475	

Ø 16"	Tire size	RIM Rec.	RIM Alt.	S.W. (mm)	O.D. (mm)	SLR (mm)	RC (mm)	Version	PR	Type	LI/SS	Load capacity (kg/tire)	
												km/h - bar	3.40
4.00 - 16	3.00 D	-	112	630	301	1877	STD	4	TT	69 A6	30	325	
4.50 - 16	3.00 D	-	122	655	311	1952	STD	4	TT	73 A6	km/h - bar	3.10	
											30	365	
5.00 - 16	4.00 E	3.00 D ; 4 J ; 4½ J	140	680	322	2025	STD	4	TT	76 A6	km/h - bar	2.80	
											30	400	
5.00 - 16	4.00 E	3.00 D ; 4 J ; 4½ J	140	680	322	2025	STD	6	TT	84 A6	km/h - bar	4.20	
											30	500	
5.00 - 16	4.00 E	3.00 D ; 4 J ; 4½ J	140	680	322	2025	SPL	6	TT	84 A6	km/h - bar	4.20	
											30	500	

Performance



Steering Control

STD: Standard - SPL: Special





TF 8181 (F-2)

Ø 16"	Tire size	RIM		S.W. (mm)	O.D. (mm)	SLR (mm)	RC (mm)	Version	PR	Type	LI/SS	Load capacity (kg/tire)	
		Rec.	Alt.									km/h - bar	3.70
5.50 - 16	4.00 E	3.50 D ; 4.50 E	158	720	340	2145	STD	6	TT	86 A6		30	530
5.50 - 16	4.00 E	3.50 D ; 4.50 E	158	720	340	2145	SPL	6	TT	86 A6		30	530
6.00 - 16	4.50 E	4.00 E ; 5 K ; 5.00 F	173	745	350	2220	STD	6	TT	88 A6		30	560
6.00 - 16	4.50 E	4.00 E ; 5 K ; 5.00 F	173	745	350	2220	STD	8	TT	94 A6		30	670
6.00 - 16	4.50 E	4.00 E ; 5 K ; 5.00 F	173	745	350	2220	SPL	6	TT	88 A6		30	560
6.00 - 16	4.50 E	4.00 E ; 5 K ; 5.00 F	173	745	350	2220	SPL	8	TT	94 A6		30	670
6.50 - 16	4.50 E	4.00 E ; 5 K ; 5.00 F ; 5.50 F	180	770	361	2295	STD	6	TT	91 A6		30	615
6.50 - 16	4.50 E	4.00 E ; 5 K ; 5.00 F ; 5.50 F	180	770	361	2295	HD	8	TT	98 A6		30	750
6.50 - 16	4.50 E	4.00 E ; 5 K ; 5.00 F ; 5.50 F	180	770	361	2295	SPL	10	TT	102 A6		30	850
6.50 - 16	4.50 E	4.00 E ; 5 K ; 5.00 F ; 5.50 F	180	770	361	2295	SPL	6	TT	91 A6		30	615
7.50 - 16	5.50 F	5.00 F ; 5 K ; 6.00 F	205	820	383	2445	STD	10	TT	109 A6		30	1030

Performance



Steering Control

STD: Standard - SPL: Special - HD: Heavy Duty



TF 8181 (F-2)

Ø 16"	Tire size	RIM		S.W. (mm)	O.D. (mm)	SLR (mm)	RC (mm)	Version	PR	Type	LI/SS	Load capacity (kg/tire)		
		Rec.	Alt.									km/h - bar	2.80	
7.50 - 16	5.50 F	5.00 F; 5 K; 6.00 F	205	820	383	2445	STD	6	TT	98 A6		30	750	
												km/h - bar	3.70	
7.50 - 16	5.50 F	5.00 F; 5 K; 6.00 F	205	820	383	2445	STD	8	TT	103 A6		30	875	
												km/h - bar	5.50	
7.50 - 16	5.50 F	5.00 F; 5 K; 6.00 F	205	820	383	2445	IMP	14	TT	122 A6		30	1500	
												km/h - bar	2.80	
7.50 - 16	5.50 F	5.00 F; 5 K; 6.00 F	205	820	383	2445	SPL	6	TT	98 A6		30	750	
												km/h - bar	3.70	
7.50 - 16	5.50 F	5.00 F; 5 K; 6.00 F	205	820	383	2445	SPL	8	TT	103 A6		30	875	
												km/h - bar	2.80	
10.00 - 16	W 8	W 8 L	273	895	411	2667	STD	8	TT	115 A6		30	1215	
												km/h - bar	2.50	
11.00 - 16	W 10 L	W 8 ; W 8 L	326	970	447	2920	STD	8	TT	118 A6		30	1320	
												km/h - bar	4.20	
Ø 18"	6.00 - 18	4.50 E	4.00 E; 5.00 F	172	800	374	2410	STD	8	TT	101 A6		30	825
													km/h - bar	2.80
7.50 - 18	5.50 F	-	208	875	410	2605	STD	6	TT	101 A6		30	825	
												km/h - bar	3.70	
7.50 - 18	5.50 F	-	208	875	410	2605	STD	8	TT	106 A6		30	950	
												km/h - bar	3.70	
7.50 - 18	5.50 F	-	208	875	410	2605	HD	8	TT	106 A6		30	950	
												km/h - bar		

Performance



STD: Standard - SPL: Special - IMP: Implement - HD: Heavy Duty



TF 8181 (F-2)

Ø 18"	Tire size	RIM		S.W. (mm)	O.D. (mm)	SLR (mm)	RC (mm)	Version	PR	Type	LI/SS	Load capacity (kg/tire)	
		Rec.	Alt.									km/h - bar	2.80
7.50 - 18	5.50 F	-	208	875	410	2605	SPL	6	TT	101 A6	30	825	
7.50 - 18	5.50 F	-	208	875	410	2605	SPL	8	TT	106 A6	30	950	
Ø 19"	6.00 - 19	4.50 E	4.00 E; 5.00 F	174	830	385	2425	STD	6	TT	93 A6/ 89 A8	km/h - bar	3.30
												30	650
Ø 20"	6.50 - 20	5.00 F	4.00 E; 5.50 F	180	865	409	2578	STD	6	TT	97 A6	30	730
	6.50 - 20	5.00 F	4.00 E; 5.50 F	180	865	409	2578	STD	8	TT	101 A6	30	825
	6.50 - 20	5.00 F	4.00 E; 5.50 F	180	865	409	2578	SPL	8	TT	101 A6	30	825
	7.50 - 20	5.50 F	5.00 F	205	915	431	2725	STD	6	TT	103 A6	30	875
	7.50 - 20	5.50 F	5.00 F	205	915	431	2725	STD	8	TT	109 A6	30	1030
	7.50 - 20	5.50 F	5.00 F	205	915	431	2725	HD	6	TT	103 A6	30	875
	7.50 - 20	5.50 F	5.00 F	205	915	431	2725	HD	8	TT	109 A6	30	1030
	7.50 - 20	5.50 F	5.00 F	205	915	431	2725	SPL	8	TT	109 A6	30	1030

Performance



STD: Standard - SPL: Special - HD: Heavy Duty



TF 9090 (F-2)

TF 9090 is a tire designed for small tractors in soil tillage operations. The special tread design provides excellent steering performance on loose soil.

Ø 12"	Tire size	RIM		S.W. (mm)	O.D. (mm)	SLR (mm)	RC (mm)	Version	PR	Type	LI/SS	Load capacity (kg/tire)	
		Rec.	Alt.									km/h - bar	
4.00 - 12	3.00 D	2.50 C	112	530	255	1573	STD	4	TT	60 A6	30	3.40	
											30	250	
4.00 - 12	3.00 D	2.50 C	112	530	255	1573	STD	6	TT	68 A6	30	5.10	
											30	315	
Ø 15"	5.00 - 15	4.00 E	3.00 D ; 4 J ; 4½ J	140	655	307	1951	STD	4	TT	73 A6	30	2.80
												30	365
5.00 - 15	4.00 E	3.00 D ; 4 J ; 4½ J	140	655	307	1951	STD	6	TT	82 A6	30	3.70	
											30	475	
Ø 16"	4.00 - 16	3.00 D	-	112	630	301	1877	STD	4	TT	69 A6	30	3.40
												30	325
5.50 - 16	4.00 E	3.50 D ; 4.50 E	150	710	332	2116	STD	6	TT	86 A6	30	3.70	
											30	530	
6.00 - 16	4.50 E	4.00 E ; 5 K ; 5.00 F	170	735	346	2190	STD	6	TT	88 A6	30	3.30	
											30	560	
6.00 - 16	4.50 E	4.00 E ; 5 K ; 5.00 F	170	735	346	2190	STD	8	TT	94 A6	30	4.50	
											30	670	
6.00 - 16	4.50 E	4.00 E ; 5 K ; 5.00 F	170	735	346	2190	SPL	6	TT	88 A6	30	3.30	
											30	560	
6.00 - 16	4.50 E	4.00 E ; 5 K ; 5.00 F	170	735	346	2190	SPL	8	TT	94 A6	30	4.50	
											30	670	

Performance



Steering Control

STD: Standard - SPL: Special



TF 9090 (F-2)

Ø 16"	Tire size	RIM		S.W. (mm)	O.D. (mm)	SLR (mm)	RC (mm)	Version	PR	Type	LI/SS	Load capacity (kg/tire)	
		Rec.	Alt.									km/h - bar	3.10
6.50 - 16	4.50 E	4.00 E; 5 K; 5.00 F; 5.50 F		180	765	359	2280	STD	6	TT	91 A6	30	615
6.50 - 16	4.50 E	4.00 E; 5 K; 5.00 F; 5.50 F		180	765	359	2280	STD	8	TT	98 A6	30	750
7.50 - 16	5.50 F	5.00 F; 5 K; 6.00 F		207	810	379	2414	STD	6	TT	98 A6	30	750
7.50 - 16	5.50 F	5.00 F; 5 K; 6.00 F		207	810	379	2414	STD	8	TT	103 A6	30	875
7.50 - 16	5.50 F	5.00 F; 5 K; 6.00 F		207	810	379	2414	STD	10	TT	109 A6	30	1030
7.50 - 16	5.50 F	5.00 F; 5 K; 6.00 F		207	810	379	2414	SPL	6	TT	98 A6	30	750
7.50 - 16	5.50 F	5.00 F; 5 K; 6.00 F		207	810	379	2414	SPL	8	TT	103 A6	30	875
9.00 - 16	W 8	6.00 F; W 7; W 8 L		257	855	398	2548	STD	8	TT	111 A6	30	1090
9.00 - 16	W 8	6.00 F; W 7; W 8 L		257	855	398	2548	STD	10	TT	116 A6	30	1250
9.00 - 16	W 8	6.00 F; W 7; W 8 L		257	855	398	2548	SPL	10	TT	116 A6	30	1250
10.00 - 16	W 8	W 8 L		275	900	409	2714	STD	8	TT	115 A6	30	1215
10.00 - 16	W 8	W 8 L		275	900	409	2714	STD	10	TT	119 A6	30	1360

Performance



Steering Control

STD: Standard - SPL: Special





TF 9090 (F-2)

Ø 16"	Tire size	RIM		S.W. (mm)	O.D. (mm)	SLR (mm)	RC (mm)	Version	PR	Type	LI/SS	Load capacity (kg/tire)	
		Rec.	Alt.									km/h - bar	2.80
10.00 - 16	W 8	W 8 L		275	900	409	2714	SPL	8	TT	115 A6	30	1215
10.00 - 16	W 8	W 8 L		275	900	409	2714	SPL	10	TT	119 A6	30	1360
11.00 - 16	W 10 L	W 8 ; W 8 L		320	970	448	2890	STD	8	TT	118 A6	30	1320
11.00 - 16	W 10 L	W 8 ; W 8 L		320	970	448	2890	STD	8	TL	118 A6	30	1320
11.00 - 16	W 10 L	W 8 ; W 8 L		320	970	448	2890	SPL	8	TT	118 A6	30	1320
Ø 18"	7.50 - 18	5.50 F	-	207	860	404	2562	STD	6	TT	101 A6	30	825
	7.50 - 18	5.50 F	-	207	860	404	2562	STD	8	TT	106 A6	30	950
	7.50 - 18	5.50 F	-	207	860	404	2562	SPL	6	TT	101 A6	30	825
	7.50 - 18	5.50 F	-	207	860	404	2562	SPL	8	TT	106 A6	30	950
	7.50 - 18	5.50 F	-	207	860	404	2562	STD	10	TT	113 A6	30	1150
Ø 19"	4.00 - 19	3.00 D	-	115	715	343	2145	STD	4	TT	72 A6	30	355
	6.00 - 19	4.50 E	4.00 E ; 5.00 F	167	815	386	2445	STD	6	TT	93 A6	30	650

Performance



Steering Control

STD: Standard - SPL: Special





FRONT

TF 9090 (F-2)

Ø 20"	Tire size	RIM		S.W. (mm)	O.D. (mm)	SLR (mm)	RC (mm)	Version	PR	Type	LI/SS	Load capacity (kg/tire)	
		Rec.	Alt.									km/h - bar	
	7.50 - 20	5.50 F	5.00 F	205	915	431	2725	STD	6	TT	103 A6	30	2.80 875
	7.50 - 20	5.50 F	5.00 F	205	915	431	2725	STD	8	TT	109 A6	30	3.40 1030
	7.50 - 20	5.50 F	5.00 F	205	915	431	2725	SPL	6	TT	103 A6	30	2.80 875
	7.50 - 20	5.50 F	5.00 F	205	915	431	2725	SPL	8	TT	109 A6	30	3.40 1030

Performance



Steering Control

STD: Standard - SPL: Special

Bias

TF 9393 (F-2)



TF 9393 is an agricultural front tire specifically designed for small tractors in soils tillage applications and it is particularly suitable on loose soils. Its tread shows a wide center part and shoulder ribs. The special tread design provides excellent steering performance on all surfaces.

Ø 16"	Tire size	RIM		S.W. (mm)	O.D. (mm)	SLR (mm)	RC (mm)	Version	PR	Type	LI/SS	Load capacity (kg/tire)	
		Rec.	Alt.									km/h - bar	
	7.50 - 16	5.50 F	5.00 F ; 6.00 F	210	810	-	-	STD	8	TT	103 A6	30	3.70 875

Performance



Steering Control

STD: Standard



COMMANDER (F) (F-2)

COMMANDER (F) is a front 3-rib pattern tire - perfect for soil tillage and haulage applications. Its deep tread made of a cut-and-chip resistant compound ensures a longer tire life, together with high load capacity.

Ø 16"	Tire size	RIM		S.W. (mm)	O.D. (mm)	SLR (mm)	RC (mm)	Version	PR	Type	LI/SS	Load capacity (kg/tire)	
		Rec.	Alt.									km/h - bar	
	5.50 - 16	4.00 E	3.50D ; 4.50E	155	720	340	2145	STD	6	TT	86 A6	30	530
	6.00 - 16	4.50 E	4.00 E ; 5.00 F	175	750	357	2308	STD	8	TT	94 A6	30	670
	6.50 - 16	4.50 E	4.00 E ; 5.00 F ; 5.50 F	183	770	362	2332	STD	8	TT	98 A6	30	750
	6.50 - 16	4.50 E	4.00 E ; 5.00 F ; 5.50 F	183	770	362	2332	STD	10	TT	102 A6	30	850
	7.50 - 16	5.50 F	5.00 F ; 5 K ; 6.00 F	210	810	376	2433	STD	8	TT	103 A6	30	875

STD: Standard

Technologies



Deep Tread

Performance



Cut and Chip Resistance



Durability



High Load Capacity





COMMANDER TWIN RIB (F-2)

COMMANDER TWIN RIB is a 4-rib pattern tire with shoulder notches providing excellent grip. Its wider tread profile ensures good weight distribution. The strong casing along with a superior tread compound provide a longer tire life. COMMANDER TWIN RIB is perfect for soil tillage and haulage applications.

Ø 15"	Tire size	RIM		S.W. (mm)	O.D. (mm)	SLR (mm)	RC (mm)	Version	PR	Type	LI/SS	Load capacity (kg/tire)	
		Rec.	Alt.									km/h - bar	
	5.00 - 15	4.00 E	-	145	665	-	-	STD	6	TT	82 A6	30	475
	6.00 - 16	4.50 E	4.00 E ; 5.00 F	170	750	-	-	STD	8	TT	94 A6	30	670
	6.50 - 16	4.50 E	4.00 E ; 5.00 F ; 5.50 F	180	761	-	-	STD	8	TT	98 A6	30	750
	7.50 - 16	5.50 F	5.00 F ; 5 K ; 6.00 F	210	810	-	-	STD	8	TT	103 A6	30	875
	6.50 - 20	5.00 F	4.00 E ; 5.50 F	190	875	-	-	STD	8	TT	101 A6	30	825

Technologies



Deep Tread

Performance



Cut and Chip Resistance



Durability



High Load Capacity

STD: Standard

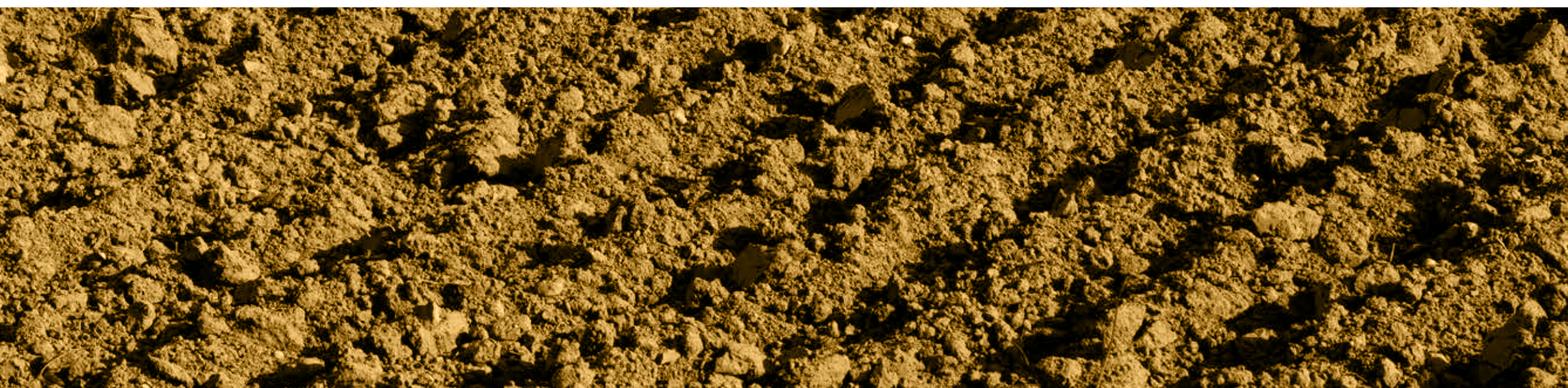



FRONT

Bias



COMMANDER 3 RIB (F-2)

COMMANDER 3 RIB is a 3-rib pattern front tire designed for soil tillage and haulage operations. It provides excellent durability and load capacity thanks to the optimized weight distribution on center and shoulder ribs. The strong casing along with the cut-and-chip resistant compound ensure outstanding puncture resistance.

Ø 16"	Tire size	RIM		S.W. (mm)	O.D. (mm)	SLR (mm)	RC (mm)	Version	PR	Type	LI/SS	Load capacity (kg/tire)		
		Rec.	Alt.									km/h - bar		
	6.00 - 16	4.50 E	4.00 E ; 5.00 F	175	740	-	-	STD	8	TT	94 A6	30	4.50 670	
	6.50 - 16	4.50 E	4.00 E ; 5.00 F ; 5.50 F	183	765	-	-	STD	8	TT	98 A6	30	4.20 750	

STD: Standard

Technologies



Deep Tread

Performance



Cut and Chip Resistance



Durability



High Load Capacity



FRONT

Bias



POWER RIB F2 (F-2)

POWER RIB F2 has been specially designed for 2WD tractors in soil tillage applications. This field-oriented tire is particularly suitable for all operations where excellent steering performance is required.

Ø 15"	Tire size	RIM		S.W. (mm)	O.D. (mm)	SLR (mm)	RC (mm)	Version	PR	Type	LI/SS	Load capacity (kg/tire)		
		Rec.	Alt.									km/h - bar		
	11L - 15 SL	8 LB	10 LB	279	813	374	2423	STD	8	TL	110 A6	30	3.00 1060	

STD: Standard

Performance



Steering Control



PRO RIB F2M (F-2M)

PRO RIB F2M is an agricultural tire for 2WD tractors in soil tillage applications. It is particularly suitable for all operations requiring a high level of handling.

Ø 15"	Tire size	RIM		S.W. (mm)	O.D. (mm)	SLR (mm)	RC (mm)	Version	PR	Type	LI/SS	Load capacity (kg/tire)			
		Rec.	Alt.									km/h - bar			
9.5L - 15 SL	7.00	8 LB	240	780	364	2325	STD	8	TL	102 A8		40	3.30	850	
	11L - 15 SL	8 LB	10 LB	280	795	370	2370	STD	8	TL	106 A8		40	3.00	950
Ø 16"	10.00 - 16 SL	8 LB	W 8 L	275	894	409	2620	STD	8	TL	110 A8		40	3.00	1060
	10.00 - 16 SL	8 LB	W 8 L	275	894	409	2620	STD	8	TT	110 A8		40	3.00	1060
10.00 - 16 SL	8 LB	W 8 L	275	894	409	2620	IND	8	TT	110 A8		40	3.00	1060	
11.00 - 16 SL	10 LB	W 8 L; 8 LB	335	950	440	2830	STD	8	TT	114 A8		40	2.80	1180	
11.00 - 16 SL	10 LB	W 8 L; 8 LB	335	950	440	2830	STD	8	TL	114 A8		40	2.80	1180	
11.00 - 16 SL	10 LB	W 8 L; 8 LB	335	950	440	2830	IND	8	TT	114 A8		40	2.80	1180	
Ø 16.1"	14L - 16.1 SL	W 11 C	-	355	980	453	2920	STD	12	TL	127 A8		40	3.60	1750
	16.5L - 16.1 SL	W 14 C	W 14 CH	430	1072	-	-	STD	10	TL	129 A8		40	2.80	1850

Performance



Steering Control

STD: Standard - IND: Industrial



RIB F3 (F-3)

RIB F3 is a field-oriented tire designed for 2WD tractors in soil tillage and haulage operations. Some sizes are suitable for transport applications using trailers. The RIB F3 tire is the ideal partner for all operations that require a high level of handling. It has been designed with a hard compound to ensure great durability and stubble resistance.

Ø 16"	Tire size	RIM		S.W. (mm)	O.D. (mm)	SLR (mm)	RC (mm)	Version	PR	Type	LI/SS	Load capacity (kg/tire)	
		Rec.	Alt.									km/h - bar	
9.00 - 16	W 8	6.00 F; W 7; W 8 L	245	878	387	2573	STD	12	TT	120 A6/ 112 A8		30	470
												40	1400
													1120
9.00 - 16	W 8	6.00 F; W 7; W 8 L	245	878	387	2573	STD	12	TL	120 A6/ 112 A8		30	470
												40	1400
													1120
9.00 - 16	W 8	6.00 F; W 7; W 8 L	245	878	387	2573	HD	12	TT	120 A6/ 112 A8		30	470
												40	1400
													1120

STD: Standard - HD: Heavy Duty

Technologies



Hard Compound

Performance



Durability



Steering Control



Stubble Resistance





STEER FARM (F-2)

STEER FARM has been designed for 2WD tractors in soil tillage applications, providing excellent steering performance.

Ø 14"	Tire size	RIM		S.W. (mm)	O.D. (mm)	SLR (mm)	RC (mm)	Version	PR	Type	LI/SS	Load capacity (kg/tire)		
		Rec.	Alt.									km/h - bar	4.50	
	5.20 - 14	3.50 D	4.00 E	135	625	296	1837	STD	6	TT	75 A6	30	387	
	6.00 - 16	4.50 E	4.00 E ; 5 K ; 5.00 F	170	740	353	2279	STD	8	TT	94 A6	km/h - bar	4.50	
												30	670	
	6.50 - 16	4.50 E	4.00 E ; 5.00 F ; 5.50 F	185	770	-	-	STD	8	TT	98 A6	km/h - bar	4.20	
												30	750	
	7.50 - 16	5.50 F	5.00 F ; 5 K ; 6.00 F	205	805	378	2451	STD	8	TT	103 A6	km/h - bar	3.70	
												30	875	
	7.50 - 16	5.50 F	5.00 F ; 5 K ; 6.00 F	205	805	378	2451	STD	10	TT	109 A6	km/h - bar	4.80	
												30	1030	
	Ø 20"	6.50 - 20	5.50 F	4.00 E ; 5.00 F	196	878	418	2701	STD	8	TT	101 A6	km/h - bar	4.50
												30	825	

Performance



Steering Control

STD: Standard



IMPLEMENT





IMPLEMENT

Radial



AW 711

AW 711 is a radial implement tire specially designed for modern farming, and suitable for haulage, hay harvesting and soil tillage applications. Thanks to its special tread compound, AW 711 has an extended product life-cycle, whether it is used on soft or hard surfaces. The low rolling resistance during on-road travel ensures significant savings in fuel consumption. Thanks to the VF technology, AW 711 can carry heavy loads at low inflating pressure.

Ø 16.5"	Tire size	LI/SS	RIM		S.W. (mm)	O.D. (mm)	SLR (mm)	RC (mm)	SRI (index)	Version	Load capacity (kg/tire)									
			Rec.	Alt.							km/h - bar	0.8	1.2	1.6	2.0	2.4	2.8	3.2	3.6	4.0
265/70 R 16.5 (10 R 16.5)	134 A8/B	8.25	-	264	773	343	2286	370	SR	km/h - bar	0.8	1.2	1.6	2.0	2.4	2.8	3.2	3.6	4.0	
										50	680	895	1085	1255	1445	1635	1760	1930	2120	
										40	680	895	1085	1255	1445	1635	1760	1930	2120	
										30	760	1000	1215	1405	1615	1830	1975	2165	2375	
										25	810	1065	1290	1490	1720	1945	2100	2300	2525	
										20	860	1125	1365	1580	1820	2060	2225	2435	2675	
10	955	1250	1515	1755	2020	2290	2470	2705	2970											
305/70 R 16.5 (12 R 16.5)	148 A8/B	9.75	-	325	851	371	2552	410	SR	km/h - bar	0.8	1.2	1.6	2.0	2.4	2.8	3.2	3.6	4.0	5.0
										50	945	1230	1515	1735	2020	2300	2460	2710	2965	3150
										40	945	1230	1515	1735	2020	2300	2460	2710	2965	3150
										30	1060	1380	1695	1945	2260	2580	2755	3040	3320	3530
										25	1125	1465	1800	2065	2400	2740	2925	3225	3525	3750
										20	1195	1550	1910	2185	2545	2900	3100	3415	3735	3970
10	1325	1720	2120	2430	2825	3220	3440	3795	4150	4410										
340/60 R 16.5	145 A8/B	11	-	324	820	368	2476	390	SR	km/h - bar	0.8	1.2	1.6	2.0	2.4	2.8	3.2	3.6	4.0	5.0
										50	870	1135	1395	1595	1860	2120	2265	2495	2730	2900
										40	870	1135	1395	1595	1860	2120	2265	2495	2730	2900
										30	975	1270	1560	1790	2080	2375	2535	2795	3055	3250
										25	1040	1350	1660	1905	2215	2525	2695	2975	3250	3455
										20	1100	1430	1755	2015	2340	2670	2855	3145	3440	3655
10	1220	1585	1950	2235	2600	2965	3170	3495	3820	4060										
380/55 R 16.5	150 A8/B	12	11.75	360	830	372	2500	390	SR	km/h - bar	0.8	1.2	1.6	2.0	2.4	2.8	3.2	3.6	4.0	5.0
										50	1005	1310	1610	1845	2145	2450	2615	2885	3150	3350
										40	1005	1310	1610	1845	2145	2450	2615	2885	3150	3350
										30	1130	1465	1805	2070	2405	2745	2930	3230	3530	3755
										25	1200	1560	1920	2195	2555	2915	3115	3435	3755	3990
										20	1270	1650	2030	2325	2705	3085	3300	3635	3975	4225
10	1410	1830	2255	2580	3005	3425	3660	4035	4410	4690										
395/55 R 16.5	152 A8/B	12	-	394	838	365	2516	400	SR	km/h - bar	0.8	1.2	1.6	2.0	2.4	2.8	3.2	3.6	4.0	5.0
										50	1065	1385	1705	1955	2275	2595	2770	3055	3340	3550
										40	1065	1385	1705	1955	2275	2595	2770	3055	3340	3550
										30	1195	1555	1915	2190	2550	2910	3105	3425	3745	3980
										25	1270	1650	2030	2325	2705	3085	3300	3635	3975	4225
										20	1345	1750	2150	2465	2865	3270	3495	3850	4210	4475
10	1495	1940	2390	2735	3185	3630	3880	4275	4675	4970										

SR: Stubble Resistant

Technologies



Steel Belted



VF Technology



IF Technology

Performance



Durability



Fuel Economy



High Load Capacity



Stubble Resistance





IMPLEMENT

AW 711

Ø 16.5"	Tire size	LI/SS	RIM		S.W. (mm)	O.D. (mm)	SLR (mm)	RC (mm)	SRI (index)	Version	Load capacity (kg/tire)												
			Rec.	Alt.							km/h - bar	0.8	1.2	1.6	2.0	2.4	2.8	3.2	3.6	4.0	4.6		
	VF 410/50 R 16.5	153 B	AG 11.75	-	410	835	350	2513	400	SB	From 10 to 50	1025	1345	1630	1890	2175	2465	2655	2910	3195	3650		
											km/h - bar	0.8	1.2	1.6	2.0	2.4	2.8	3.2	3.6	4.0	5.0		
	VF 480/45 R 17	167 A8/B	16.00	-	491	866	363	2644	410	SB	From 10 to 50	1585	2020	2455	2780	3220	3655	4035	4415	4855	5450		
											km/h - bar	0.8	1.2	1.6	2.0	2.4	2.8	3.2	3.6	3.8	4.0	5.0	5.5
											50	1220	1585	1950	2235	2600	2965	3165	3490	3655	3815	4057	4375
											40	1220	1585	1950	2235	2600	2965	3165	3490	3655	3815	4057	4375
											30	1365	1775	2185	2500	2910	3320	3550	3910	4095	4275	4545	4900
											25	1450	1885	2320	2660	3095	3530	3770	4155	4350	4545	4830	5210
											20	1535	1995	2460	2815	3275	3735	3990	4400	4605	4810	5115	5515
											10	1705	2220	2730	3125	3640	4150	4435	4885	5115	5340	5680	6125
											km/h - bar	0.8	1.2	1.6	2.0	2.4	2.8	3.2	3.6	4.0	5.0		
											50	1315	1710	2100	2410	2800	3195	3415	3765	4115	4375		
											40	1315	1710	2100	2410	2800	3195	3415	3765	4115	4375		
											30	1470	1915	2355	2695	3140	3580	3825	4215	4610	4900		
											25	1565	2035	2505	2870	3335	3805	4065	4485	4900	5210		
											20	1655	2155	2650	3035	3530	4030	4305	4745	5185	5515		
											10	1840	2390	2940	3370	3920	4475	4780	5270	5760	6125		
											km/h - bar	0.8	1.2	1.6	2.0	2.4	2.8	3.2	3.6	4.0			
											From 10 to 50	1170	1535	1865	2155	2485	2815	3030	3325	3650			
											km/h - bar	0.8	1.2	1.6	2.0	2.4	2.8	3.2	3.6	4.0	5.0	5.5	
											65	660	855	1045	1170	1365	1535	1705	1850	2045	2285	2430	
											50	840	1090	1340	1495	1745	1960	2180	2365	2615	2925	3110	
											40	885	1145	1405	1565	1830	2055	2285	2480	2740	3065	3260	
											25	960	1245	1530	1710	1995	2240	2490	2705	2990	3345	3555	
											10	1335	1730	2125	2370	2765	3110	3455	3755	4150	4640	4935	

SR: Stubble Resistant - SB: Steel Belted

Technologies



Steel Belted



VF Technology



IF Technology

Performance



Durability



Fuel Economy



High Load Capacity



Stubble Resistance



IMPLEMENT

Radial



AW 712

AW 712 is an implement radial tire that is particularly suitable for slurry tank trucks and trailers. It features a strong casing in addition to a stubble-resistant compound to ensure great durability. AW 712 provides also excellent driving comfort.

Ø 15.3"	Tire size	LI/SS	RIM		S.W. (mm)	O.D. (mm)	SLR (mm)	RC (mm)	SRI (index)	Version	Load capacity (kg/tire)											
			Rec.	Alt.							km/h - bar	0.8	1.2	1.6	2.0	2.4	2.8	3.2	3.6	4.0	5.0	6.0
260/70 R 15.3	134 A8/B	9.00	-	264	760	344	2304	370	IMP	50	615	785	955	1105	1275	1445	1550	1720	1780	1995	2120	
										40	615	785	955	1105	1275	1445	1550	1720	1780	1995	2120	
										30	690	880	1070	1235	1425	1615	1735	1925	1990	2235	2375	
										25	735	935	1140	1315	1515	1720	1845	2050	2115	2375	2525	
										20	780	990	1205	1375	1605	1820	1955	2170	2240	2515	2675	
										10	865	1100	1340	1545	1785	2020	2170	2410	2490	2795	2970	

IMP: Implement

Performance



Comfort



Durability



Stubble Resistance

Radial



IMPLEMENT



AS 511

AS 511 is best suited for grassland operations with implement machinery. The robust casing and the special cut-resistant tread compound ensure extraordinary stability plus enhanced performance. Thanks to its large contact area, AS 511 ensures excellent traction and minimizes soil compaction.

Ø 15"	Tire size	LI/SS	RIM		S.W. (mm)	O.D. (mm)	SLR (mm)	RC (mm)	SRI (index)	Version	Load capacity (kg/tire)	
			Rec.	Alt.							km/h - bar	2.8
31 X 15.50 R 15	122 B	13 LB	-	388	785	353	2387	380	STD	50	1500	

STD: Standard

Performance



Cut and Chip Resistance



Reduced Soil Compaction



Stability



Traction



IMPLEMENT

Radial



RM 500

RM 500 is a steel-belted radial tire suitable for harvester implement applications. It features a strong casing and a special tread design providing high load capacity and particular cut-and-chip resistance. Thanks to its large footprint, RM 500 ensures great pressure distribution on the ground with reduced soil compaction in addition to excellent traction.

Ø 24"	Tire size	RIM		S.W. (mm)	O.D. (mm)	SLR (mm)	RC (mm)	SRI (index)	Version	LI/SS Drive Wheel	LI/SS Free Rolling	Load capacity (kg/tire)									
		Rec.	Alt.									km/h - bar	0.8	1.0	1.2	1.6	2.0	2.4	2.8		
												40 Free Rolling	40 Drive Wheel	40 Free Rolling	40 Drive Wheel	40 Free Rolling	40 Drive Wheel	40 Free Rolling	40 Drive Wheel	40 Free Rolling	40 Drive Wheel
500/70 R 24	W 16 L	W 15 L	502	1310	572	3907	625	SB	155 A8	167 A8	km/h - bar	0.8	1.0	1.2	1.6	2.0	2.4	2.8			
	40 Free Rolling	2290	2620	2945	3600	4145	4800	5450	40 Drive Wheel	1630	1860	2095	2560	3945	3410	3875					
	500/85 R 24	W 16 L	W 15 L	520	1460	622	4382	700	SB	170 A8	182 A8	km/h - bar	1.2	1.6	2.0	2.4	2.8	3.2	3.6	4.0	
40 Free Rolling	3570	4335	5015	5780	6545	7055	7735	8500	40 Drive Wheel	2520	3060	3540	4080	4620	4980	5460	6000				
	Ø 28"	500/80 R 28	W 16 L	W 15 L	503	1495	635	4355	700	SB	164 A8	176 A8	km/h - bar	0.8	1.0	1.2	1.6	2.0	2.4	2.8	3.2
			40 Free Rolling	2770	3195	3550	4405	5045	5825	6605	7100	40 Drive Wheel	1950	2250	2500	3100	3550	4100	4650	5000	
600/65 R 28			W 18 L	W 20 L	590	1486	640	4340	700	SB	156 A8	168 A8	km/h - bar	0.8	1.0	1.2	1.6	2.0	2.4	2.8	
40 Free Rolling	3080	3530	3980	4820	5600	40 Drive Wheel	2200	2520	2840	3440	4000										
	600/65 R 28	W 18 L	W 20 L	590	1486	640	4340	700	SB	165 A8	177 A8	km/h - bar	0.8	1.0	1.2	1.6	2.0	2.4	2.8		
		40 Free Rolling	3070	3505	3945	4820	5550	6425	7300	40 Drive Wheel	2165	2475	2785	3400	3915	4535	5150				
Ø 30"		500/85 R 30	W 16 L	W 15 L	535	1610	674	4745	775	SB	164 A8	176 A8	km/h - bar	0.8	1.0	1.2	1.6	2.0	2.4	2.8	
	40 Free Rolling		2985	3410	3835	4690	5400	6250	7100	40 Drive Wheel	2100	2400	2700	3300	3800	4400	5000				

SB: Steel Belted

Technologies



Steel Belted

Performance



High Load Capacity



High Puncture Resistance



Stability



Traction

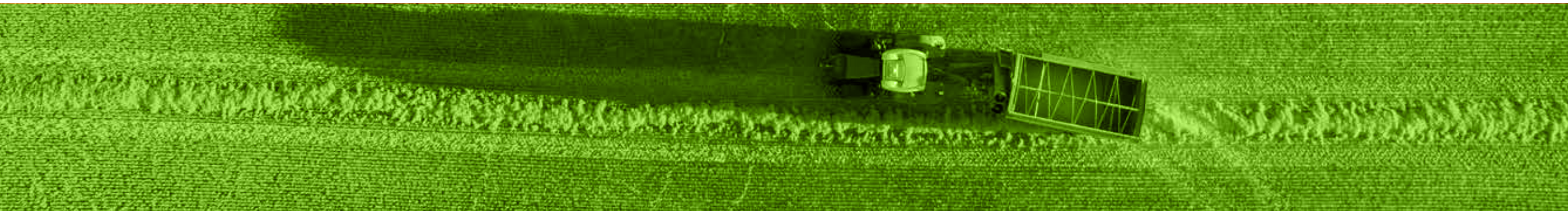



IMPLEMENT

Bias



AW 702

AW 702 has been developed for implement machinery, trailers and balers in soil tillage and haulage applications. This heavy-duty tire has been designed by BKT to provide a new level of durability. AW 702 is available in different versions to meet specific end-user needs: an "aramid belted" version is available for those who need strengthened puncture resistance, the "HD" version has a special cut-and-chip resistant compound, while the "special" version provides extraordinary stubble resistance.

Ø 12"	Tire size	RIM		S.W. (mm)	O.D. (mm)	SLR (mm)	RC (mm)	Version	PR	Type	LI/SS Free Rolling	Load capacity (kg/tire)	
		Rec.	Alt.									km/h - bar	
7.00 - 12	4.25	-	185	665	295	1948	STD	6	TL	95 A8	2.50		
											10 FR	965	
											25 FR	820	
											30 FR	775	
7.00 - 12	4.25	-	185	665	295	1948	AB	6	TL	95 A8	2.50		
											10 FR	965	
											25 FR	820	
											30 FR	775	
10.0/80 - 12	9.00	7.0	264	710	317	2144	STD	8	TL	116 A8	3.10		
											10 FR	1750	
											25 FR	1490	
											30 FR	1400	
10.0/80 - 12	9.00	7.0	264	710	317	2144	STD	10	TL	121 A8	3.90		
											10 FR	2030	
											25 FR	1725	
											30 FR	1625	
10.0/80 - 12	9.00	7.0	264	710	317	2144	AB	10	TL	121 A8	3.90		
											10 FR	2030	
											25 FR	1725	
											30 FR	1625	
10.0/80 - 12	9.00	7.0	264	710	317	2144	SPL	10	TL	121 A8	3.90		
											10 FR	2030	
											25 FR	1725	
											30 FR	1625	
Ø 15.3"	10.0/75 - 15.3	9.00	-	274	760	351	2213	STD	22	TL	137 A8	7.10	
												10 FR	3220
												25 FR	2735
												30 FR	2575
											40 FR	2300	

Technologies



Aramid Belted



Hard Compound



Heavy Duty

Performance



Cut and Chip Resistance



Durability



High Load Capacity



High Puncture Resistance



Stubble Resistance

AB: Aramid Belted - STD: Standard - SPL: Special





AW 702

Ø 15.3"	Tire size	RIM		S.W. (mm)	O.D. (mm)	SLR (mm)	RC (mm)	Version	PR	Type	LI/SS Free Rolling	Load capacity (kg/tire)	
		Rec.	Alt.									km/h - bar	
10.0/75 - 15.3	9.00	-	274	760	351	2213	STD	12	TT	126 A8		km/h - bar	4.70
												10 FR	2380
												25 FR	2025
												30 FR	1905
10.0/75 - 15.3	9.00	-	274	760	351	2213	STD	12	TL	126 A8		km/h - bar	4.70
												10 FR	2380
												25 FR	2025
												30 FR	1905
10.0/75 - 15.3	9.00	-	274	760	351	2213	STD	14	TT	130 A8		km/h - bar	5.50
												10 FR	2660
												25 FR	2260
												30 FR	2130
10.0/75 - 15.3	9.00	-	274	760	351	2213	STD	14	TL	130 A8		km/h - bar	5.50
												10 FR	2660
												25 FR	2260
												30 FR	2130
10.0/75 - 15.3	9.00	-	274	760	351	2213	STD	18	TL	135 A8		km/h - bar	7.10
												10 FR	3050
												25 FR	2595
												30 FR	2440
10.0/75 - 15.3	9.00	-	274	760	351	2213	STD	8	TT	119 A8		km/h - bar	3.10
												10 FR	1905
												25 FR	1620
												30 FR	1525
10.0/75 - 15.3	9.00	-	274	760	351	2213	STD	10	TT	123 A8		km/h - bar	3.90
												10 FR	2170
												25 FR	1845
												30 FR	1735
10.0/75 - 15.3	9.00	-	274	760	351	2213	STD	10	TL	123 A8		km/h - bar	3.90
												10 FR	2170
												25 FR	1845
												30 FR	1735
10.0/75 - 15.3	9.00	-	274	760	351	2213	HD	18	TL	135 A8		km/h - bar	7.10
												10 FR	3050
												25 FR	2595
												30 FR	2440

Technologies



Aramid Belted



Hard Compound



Heavy Duty

Performance



Cut and Chip Resistance



Durability



High Load Capacity



High Puncture Resistance



Stubble Resistance

HD: Heavy Duty - STD: Standard





AW 702

Ø 15.3"	Tire size	RIM		S.W. (mm)	O.D. (mm)	SLR (mm)	RC (mm)	Version	PR	Type	LI/SS Free Rolling	Load capacity (kg/tire)	
		Rec.	Alt.									km/h - bar	
10.0/75 - 15.3	9.00	-	274	760	351	2213	SPL	14	TL	130 A8		km/h - bar	5.50
												10 FR	2660
												25 FR	2260
												30 FR	2130
11.5/80 - 15.3	9.00	-	297	844	370	2473	STD	16	TL	141 A8		km/h - bar	5.40
												10 FR	3605
												25 FR	3065
												30 FR	2885
11.5/80 - 15.3	9.00	-	297	844	370	2473	STD	18	TL	143 A8		km/h - bar	6.10
												10 FR	3815
												25 FR	3245
												30 FR	3050
11.5/80 - 15.3	9.00	-	297	844	370	2473	STD	10	TL	131 A8		km/h - bar	3.40
												10 FR	2730
												25 FR	2320
												30 FR	2185
11.5/80 - 15.3	9.00	-	297	844	370	2473	STD	12	TT	135 A8		km/h - bar	4.10
												10 FR	3050
												25 FR	2595
												30 FR	2440
11.5/80 - 15.3	9.00	-	297	844	370	2473	STD	12	TL	135 A8		km/h - bar	4.10
												10 FR	3050
												25 FR	2595
												30 FR	2440
11.5/80 - 15.3	9.00	-	297	844	370	2473	STD	14	TT	139 A8		km/h - bar	4.75
												10 FR	3400
												25 FR	2890
												30 FR	2720
11.5/80 - 15.3	9.00	-	297	844	370	2473	AB	14	TL	139 A8		km/h - bar	4.75
												10 FR	3400
												25 FR	2890
												30 FR	2720
11.5/80 - 15.3	9.00	-	297	844	370	2473	STD	16	TT	141 A8		km/h - bar	5.40
												10 FR	3605
												25 FR	3065
												30 FR	2885

Technologies



Aramid Belted



Hard Compound



Heavy Duty

Performance



Cut and Chip Resistance



Durability



High Load Capacity



High Puncture Resistance



Stubble Resistance

STD: Standard - SPL: Special - AB: Aramid Belted





AW 702

Ø 15.3"	Tire size	RIM		S.W. (mm)	O.D. (mm)	SLR (mm)	RC (mm)	Version	PR	Type	LI/SS Free Rolling	Load capacity (kg/tire)	
		Rec.	Alt.									km/h - bar	
11.5/80 - 15.3	9.00	-	297	844	370	2473	STD	18	TT	143 A8		km/h - bar	6.10
												10 FR	3815
												25 FR	3245
												30 FR	3050
11.5/80 - 15.3	9.00	-	297	844	370	2473	STD	10	TT	131 A8		km/h - bar	3.40
												10 FR	2730
												25 FR	2320
												30 FR	2185
11.5/80 - 15.3	9.00	-	297	844	370	2473	AR	14	TL	139 A8		km/h - bar	4.75
												10 FR	3400
												25 FR	2890
												30 FR	2720
12.5/80 - 15.3	9.00	-	312	885	387	2593	STD	14	TT	142 A8		km/h - bar	4.30
												10 FR	3710
												25 FR	3155
												30 FR	2970
12.5/80 - 15.3	9.00	-	312	885	387	2593	STD	16	TT	144 A8		km/h - bar	4.90
												10 FR	3920
												25 FR	3330
												30 FR	3135
12.5/80 - 15.3	9.00	-	312	885	387	2593	STD	14	TL	142 A8		km/h - bar	4.30
												10 FR	3710
												25 FR	3155
												30 FR	2970
12.5/80 - 15.3	9.00	-	312	885	387	2593	STD	16	TL	144 A8		km/h - bar	4.90
												10 FR	3920
												25 FR	3330
												30 FR	3135
12.5/80 - 15.3	9.00	-	312	885	387	2593	SPL	14	TT	142 A8		km/h - bar	4.30
												10 FR	3710
												25 FR	3155
												30 FR	2970
12.5/80 - 15.3	9.00	-	312	885	387	2593	SPL	18	TL	146 A8		km/h - bar	5.50
												10 FR	4200
												25 FR	3570
												30 FR	3360
												40 FR	3000

Technologies



Aramid Belted



Hard Compound



Heavy Duty

Performance



Cut and Chip Resistance



Durability



High Load Capacity



High Puncture Resistance



Stubble Resistance

AB: Aramid Belted - STD: Standard - SPL: Special





AW 702

Ø 16"	Tire size	RIM		S.W. (mm)	O.D. (mm)	SLR (mm)	RC (mm)	Version	PR	Type	LI/SS Free Rolling	Load capacity (kg/tire)	
		Rec.	Alt.									km/h - bar	
10.5/65 - 16	W 9	W 8 ; W 8 L	270	760	350	2329	STD	14	TT	130 A8		km/h - bar	5.30
												10 FR	2660
												25 FR	2260
												30 FR	2130
												40 FR	1900
10.5/65 - 16	W 9	W 8 ; W 8 L	270	760	350	2329	STD	14	TL	130 A8		km/h - bar	5.30
												10 FR	2660
												25 FR	2260
												30 FR	2130
												40 FR	1900
10.5/65 - 16	W 9	W 8 ; W 8 L	270	760	350	2329	STD	10	TT	123 A8		km/h - bar	3.80
												10 FR	2170
												25 FR	1845
												30 FR	1735
												40 FR	1550
10.5/65 - 16	W 9	W 8 ; W 8 L	270	760	350	2329	STD	10	TL	123 A8		km/h - bar	3.80
												10 FR	2170
												25 FR	1845
												30 FR	1735
												40 FR	1550
10.5/65 - 16	W 9	W 8 ; W 8 L	270	760	343	2112	IND	14	TL	130 A8		km/h - bar	3.60
												10 FR	2660
												25 FR	2260
												30 FR	2130
												40 FR	1900
10.5/65 - 16	W 9	W 8 ; W 8 L	270	760	350	2329	SPL	10	TL	123 A8		km/h - bar	3.80
												10 FR	2170
												25 FR	1845
												30 FR	1735
												40 FR	1550
10.50 - 16	6.00 T	-	305	975	445	2986	STD	14	TT	-		km/h - bar	6.90
												50	3215
13.0/55 - 16	11.0	-	336	770	345	2256	STD	12	TL	130 A8		km/h - bar	3.60
												10 FR	2660
												25 FR	2260
												30 FR	2130
												40 FR	1900
13.0/55 - 16	11.0	-	336	770	345	2256	STD	14	TL	133 A8		km/h - bar	4.20
												10 FR	2885
												25 FR	2450
												30 FR	2305
												40 FR	2060

Technologies



Aramid Belted



Hard Compound



Heavy Duty

Performance

Cut and Chip
Resistance

Durability



High Load Capacity

High Puncture
Resistance

Stubble Resistance

STD: Standard - SPL: Special - IND: Industrial





AW 702

Ø 16"	Tire size	RIM		S.W. (mm)	O.D. (mm)	SLR (mm)	RC (mm)	Version	PR	Type	LI/SS Free Rolling	Load capacity (kg/tire)	
		Rec.	Alt.									km/h - bar	
Ø 16"	6.00 - 16	4.00 E	4.50 E; 4½ K	169	722	334	2197	STD	6	TL	95 A8	2.75	
												10 FR	965
												25 FR	820
												30 FR	775
	6.00 - 16	4.00 E	4.50 E; 4½ K	169	722	334	2197	STD	8	TT	103 A8	4.00	
												10 FR	1225
												25 FR	1040
												30 FR	980
	6.00 - 16	4.00 E	4.50 E; 4½ K	169	722	334	2197	STD	6	TT	95 A8	2.75	
												10 FR	965
												25 FR	820
												30 FR	775
13.0/55 - 16	11.0	-	336	770	345	2256	STD	18	TL	138 A8	5.40		
											10 FR	3305	
											25 FR	2810	
											30 FR	2645	
13.0/75 - 16	11.0	9;W 9; W 11	340	890	396	2726	STD	10	TL	135 A8	3.00		
											10 FR	3050	
											25 FR	2595	
											30 FR	2440	
Ø 18"	10.5/80 - 18	W 9	W 8;9	275	885	395	2593	STD	10	TL	131 A8	3.70	
												10 FR	2730
												25 FR	2320
												30 FR	2185
	10.5/80 - 18	W 9	W 8;9	275	885	395	2593	STD	14	TL	138 A8	5.10	
												10 FR	3305
												25 FR	2810
												30 FR	2645
	12.5/80 - 18	W 9	11	308	965	432	2827	STD	12	TL	142 A8	3.70	
												10 FR	3710
												25 FR	3155
												30 FR	2970
												40 FR	2650

STD: Standard

Technologies



Aramid Belted



Hard Compound



Heavy Duty

Performance



Cut and Chip Resistance



Durability



High Load Capacity



High Puncture Resistance



Stubble Resistance





AW 702

Ø 18"	Tire size	RIM		S.W. (mm)	O.D. (mm)	SLR (mm)	RC (mm)	Version	PR	Type	LI/SS Free Rolling	Load capacity (kg/tire)	
		Rec.	Alt.									km/h - bar	
12.5/80 - 18	W 9	11	308	965	432	2827	STD	14	TL	145 A8		km/h - bar	4.30
												10 FR	4060
												25 FR	3450
												30 FR	3250
12.5/80 - 18	W 9	11	308	965	432	2827	STD	10	TL	139 A8		km/h - bar	3.10
												10 FR	3400
												25 FR	2890
												30 FR	2720
12.5/80 - 18	W 9	11	308	965	432	2827	STD	18	TL	150 A8		km/h - bar	5.50
												10 FR	4690
												25 FR	3985
												30 FR	3750
12.5/80 - 18	W 9	11	308	965	432	2827	STD	16	TL	148 A8		km/h - bar	4.90
												10 FR	4410
												25 FR	3750
												30 FR	3530
12.5/80 - 18	W 9	11	308	965	432	2827	SPL	14	TL	145 A8		km/h - bar	4.30
												10 FR	4060
												25 FR	3450
												30 FR	3250
12.5/80 - 18	W 9	11	308	965	432	2827	SPL	16	TL	148 A8		km/h - bar	4.90
												10 FR	4410
												25 FR	3750
												30 FR	3530
13.0/65 - 18	11.0	-	336	890	398	2608	STD	14	TT	141 A8		km/h - bar	4.30
												10 FR	3605
												25 FR	3065
												30 FR	2885
13.0/65 - 18	11.0	-	336	890	398	2608	STD	14	TL	141 A8		km/h - bar	4.30
												10 FR	3605
												25 FR	3065
												30 FR	2885
13.0/65 - 18	11.0	-	336	890	398	2608	STD	16	TL	144 A8		km/h - bar	4.90
												10 FR	3920
												25 FR	3330
												30 FR	3135
14.5/80 - 18	11.0	12 ; 13	362	1047	446	3068	STD	12	TT	155 A8		km/h - bar	3.40
												10 FR	4550
												25 FR	3870
												30 FR	3640
												40 FR	3250

Technologies



Aramid Belted



Hard Compound



Heavy Duty

Performance



Cut and Chip Resistance



Durability



High Load Capacity



High Puncture Resistance



Stubble Resistance

STD: Standard - SPL: Special



IMPLEMENT

Bias



AW 705

AW 705 has been developed for implement machinery, trailers and balers in soil tillage and haulage applications. It is ideal for modern farming thanks to improved durability and high load capacity.

Ø 16"	Tire size	RIM		S.W. (mm)	O.D. (mm)	SLR (mm)	RC (mm)	Version	PR	Type	LI/SS Free Rolling	Load capacity (kg/tire)	
		Rec.	Alt.									km/h - bar	
14.0/65 - 16	11.0	-	353	870	388	2549	STD	14	TT	142 A8	4.00		
											10 FR	3710	
											25 FR	3155	
											30 FR	2970	
14.0/65 - 16	11.0	-	353	870	388	2549	STD	10	TT	134 A8	2.80		
											10 FR	2970	
											25 FR	2525	
											30 FR	2375	
14.0/65 - 16	11.0	-	353	870	388	2549	STD	10	TL	134 A8	2.80		
											10 FR	2970	
											25 FR	2525	
											30 FR	2375	
14.0/65 - 16	11.0	-	353	870	388	2549	STD	14	TL	142 A8	4.00		
											10 FR	3710	
											25 FR	3155	
											30 FR	2970	
15.0/55 - 17	13.00	13 ; W 13	381	850	391	2575	STD	10	TL	134 A8	2.60		
											10 FR	2970	
											25 FR	2525	
											30 FR	2375	
15.0/55 - 17	13.00	13 ; W 13	381	850	391	2575	STD	12	TL	138 A8	3.10		
											10 FR	3305	
											25 FR	2810	
											30 FR	2645	
15.0/55 - 17	13.00	13 ; W 13	381	850	391	2575	STD	14	TL	141 A8	3.60		
											10 FR	3605	
											25 FR	3065	
											30 FR	2885	
											40 FR	2575	

Performance



Durability



High Load Capacity

STD: Standard





AW 705

Ø 17"	Tire size	RIM		S.W. (mm)	O.D. (mm)	SLR (mm)	RC (mm)	Version	PR	Type	LI/SS Free Rolling	Load capacity (kg/tire)	
		Rec.	Alt.									km/h - bar	
15.0/55 - 17	13.00	13 ;W 13	381	850	391	2575	STD	18	TL	146 A8		km/h - bar	4.70
												10 FR	4200
												25 FR	3570
												30 FR	3360
15.0/55 - 17	13.00	13 ;W 13	381	850	391	2575	STD	26	TL	155 A8		km/h - bar	7.10
												10 FR	5425
												25 FR	4610
												30 FR	4340
15.0/55 - 17	13.00	13 ;W 13	381	850	391	2575	SPL	10	TL	134 A8		km/h - bar	2.60
												10 FR	2970
												25 FR	2525
												30 FR	2375
15.0/70 - 18	13.00	13 ;W 13	405	1010	447	3092	STD	12	TL	145 A8		km/h - bar	3.10
												10 FR	4060
												25 FR	3450
												30 FR	3250
15.0/70 - 18	13.00	13 ;W 13	405	1010	447	3092	STD	14	TL	148 A8		km/h - bar	3.60
												10 FR	4410
												25 FR	3750
												30 FR	3530
15.0/70 - 18	13.00	13 ;W 13	405	1010	447	3092	STD	16	TL	151 A8		km/h - bar	4.25
												10 FR	4830
												25 FR	4105
												30 FR	3865
16.0/70 - 20	13.0	12 SDC ; 13 SDC ; 14	408	1075	480	3155	STD	12	TT	151 A8		km/h - bar	3.00
												10 FR	4830
												25 FR	4105
												30 FR	3865
16.0/70 - 20	13.0	12 SDC ; 13 SDC ; 14	408	1075	480	3155	STD	12	TL	151 A8		km/h - bar	3.00
												10 FR	4830
												25 FR	4105
												30 FR	3865
16.0/70 - 20	13.0	12 SDC ; 13 SDC ; 14	408	1075	480	3155	STD	14	TT	154 A8		km/h - bar	3.50
												10 FR	5250
												25 FR	4465
												30 FR	4200
												40 FR	3750

Performance



Durability



High Load Capacity

STD: Standard - SPL: Special





IMPLEMENT

AW 705

Ø 20"	Tire size	RIM		S.W. (mm)	O.D. (mm)	SLR (mm)	RC (mm)	Version	PR	Type	LI/SS Free Rolling	Load capacity (kg/tire)		
		Rec.	Alt.									km/h - bar		
Ø 20"	16.0/70 - 20	13.0	12 SDC ; 13 SDC ; 14	408	1075	480	3155	STD	14	TL	154 A8	3.50		
												10 FR	5250	
												25 FR	4465	
												30 FR	4200	
	16.0/70 - 20	13.0	12 SDC ; 13 SDC ; 14	408	1075	480	3155	STD	16	TL	156 A8	4.00		
												10 FR	5600	
												25 FR	4760	
												30 FR	4480	
	16.0/70 - 20	13.0	12 SDC ; 13 SDC ; 14	408	1075	480	3155	SPL	14	TL	154 A8	3.50		
												10 FR	5250	
												25 FR	4465	
												30 FR	4200	
Ø 22.5"	400/55 - 22.5	AG 11.75	12.25 ; AG 13.00	405	1016	443	3072	STD	18	TL	154 A8	4.50		
												10 FR	5250	
												25 FR	4465	
												30 FR	4200	
	400/55 - 22.5	AG 11.75	12.25 ; AG 13.00	405	1016	443	3072	SR	20	TL	156 A8	5.00		
												10 FR	5600	
												25 FR	4760	
												30 FR	4480	
													4000	

Performance



Durability



High Load Capacity

STD: Standard - SPL: Special -SR: Stubble Resistant





IMPLEMENT

Bias



AW 708

AW 708 has been developed for soil tillage, transport and hay harvesting applications with implement machinery, trailers and balers. An HD version is available with a special cut-and-chip resistant compound.

Ø 15.5"	Tire size	RIM		S.W. (mm)	O.D. (mm)	SLR (mm)	RC (mm)	Version	PR	Type	LI/SS Free Rolling	Load capacity (kg/tire)	
		Rec.	Alt.									km/h - bar	
400/60 - 15.5	AG 13.00	-	405	875	380	2564	STD	18	TL	149 A8	km/h - bar	4.50	
											10 FR	4550	
											25 FR	3870	
											30 FR	3640	
400/60 - 15.5	AG 13.00	-	405	875	380	2564	STD	10	TL	136 A8	km/h - bar	2.50	
											10 FR	3135	
											25 FR	2665	
											30 FR	2510	
400/60 - 15.5	AG 13.00	-	405	875	380	2564	STD	14	TT	145 A8	km/h - bar	3.60	
											10 FR	4060	
											25 FR	3450	
											30 FR	3250	
400/60 - 15.5	AG 13.00	-	405	875	380	2564	STD	14	TL	145 A8	km/h - bar	3.60	
											10 FR	4060	
											25 FR	3450	
											30 FR	3250	
400/60 - 15.5	AG 13.00	-	405	875	380	2564	HD	18	TL	149 A8	km/h - bar	4.50	
											10 FR	4550	
											25 FR	3870	
											30 FR	3640	
400/60 - 15.5	AG 13.00	-	405	875	380	2564	SPL	18	TL	149 A8	km/h - bar	4.50	
											10 FR	4550	
											25 FR	3870	
											30 FR	3640	
400/60 - 15.5	AG 13.00	-	405	875	380	2564	SPL	18	TT	149 A8	km/h - bar	4.50	
											10 FR	4550	
											25 FR	3870	
											30 FR	3640	

Technologies



Heavy Duty

Performance



Cut and Chip Resistance



Durability



High Load Capacity

STD: Standard - SPL: Special - HD: Heavy Duty





AW 708

Ø 15.5"	Tire size	RIM		S.W. (mm)	O.D. (mm)	SLR (mm)	RC (mm)	Version	PR	Type	LI/SS Free Rolling	Load capacity (kg/tire)	
		Rec.	Alt.									km/h - bar	
Ø 15.5"	400/60 - 15.5	AG 13.00	-	405	875	380	2564	SR	18	TL	149 A8		4.50
												10 FR	4550
												25 FR	3870
												30 FR	3640
												40 FR	3250
Ø 17"	19.0/45 - 17	16.00	-	470	866	380	2536	STD	10	TL	138 A8	km/h - bar	2.25
												10 FR	3305
												25 FR	2810
												30 FR	2645
	19.0/45 - 17	16.00	-	470	866	380	2536	STD	14	TL	144 A8	km/h - bar	2.80
												10 FR	3920
												25 FR	3330
												30 FR	3135
	19.0/45 - 17	16.00	-	470	866	380	2536	STD	18	TL	148 A8	km/h - bar	3.30
												10 FR	4410
												25 FR	3750
												30 FR	3530
	19.0/45 - 17	16.00	-	470	866	380	2536	SR	22	TL	152 A8	km/h - bar	3.90
												10 FR	4970
												25 FR	4225
												30 FR	3975
	500/50 - 17	16.00	-	500	945	416	2750	STD	10	TL	140 A8	km/h - bar	2.00
												10 FR	3500
												25 FR	2975
												30 FR	2800
	500/50 - 17	16.00	-	500	945	416	2750	STD	14	TL	149 A8	km/h - bar	2.80
												10 FR	4550
												25 FR	3870
												30 FR	3640
500/50 - 17	16.00	-	500	945	416	2750	STD	16	TL	152 A8	km/h - bar	3.20	
											10 FR	4970	
											25 FR	4225	
											30 FR	3975	
												40 FR	3550

STD: Standard - SR: Stubble Resistant

Technologies



Heavy Duty

Performance



Cut and Chip Resistance



Durability



High Load Capacity





IMPLEMENT

AW 708

Ø 17"	Tire size	RIM		S.W. (mm)	O.D. (mm)	SLR (mm)	RC (mm)	Version	PR	Type	LI/SS Free Rolling	Load capacity (kg/tire)	
		Rec.	Alt.									km/h - bar	
500/50 - 17	16.00	-	500	945	416	2750	STD	18	TL	154 A8		3.60	
												10 FR	5250
												25 FR	4465
												30 FR	4200
												40 FR	3750
500/65 - 17	16.0	-	525	1080	462	3135	STD	18	TL	160 A8		3.50	
												10 FR	6300
												25 FR	5355
												30 FR	5040
												40 FR	4500
520/50 - 17	16.00	-	516	952	404	2777	STD	-	TL	162 A8		4.00	
												10 FR	6650
												25 FR	5655
												30 FR	5320
												40 FR	4750

STD: Standard

Technologies



Heavy Duty

Performance

Cut and Chip
Resistance

Durability



High Load Capacity





IMPLEMENT

Bias



AW 726

AW 726 has been specially designed for trailers in transport operations. It is best suited for both on-and-off-the-road usage. AW 726 shows excellent road performance and self-cleaning features. The block pattern design provides an extended tire life-cycle.

Ø 15.3"	Tire size	RIM		S.W. (mm)	O.D. (mm)	SLR (mm)	RC (mm)	Version	PR	Type	LI/SS Drive Wheel	LI/SS Free Rolling	Load capacity (kg/tire)	
		Rec.	Alt.										km/h - bar	
11.5/80 - 15.3	9.00	-	300	855	363	2531	STD	14	TL	126 A8	139 A8	km/h - bar	4.80	
												10 FR	3400	
												25 FR	2890	
												30 FR	2720	
												40 FR	2430	
												10 DW	2380	
												25 DW	2025	
												30 DW	1905	
40 DW	1700													
11.5/80 - 15.3	9.00	-	300	855	363	2531	AB	14	TL	126 A8	139 A8	km/h - bar	4.80	
												10 FR	3400	
												25 FR	2890	
												30 FR	2720	
												40 FR	2430	
												10 DW	2380	
												25 DW	2025	
												30 DW	1905	
40 DW	1700													
11.5/80 - 15.3	9.00	-	300	855	373	2540	SB	14	TL	126 A8	139 A8	km/h - bar	4.80	
												10 FR	3400	
												25 FR	2890	
												30 FR	2720	
												40 FR	2430	
												10 DW	2380	
												25 DW	2025	
												30 DW	1905	
40 DW	1700													
Ø 15.5"	400/60 - 15.5	AG 13.00	-	400	875	-	-	STD	18	TL	137 A8	149 A8	km/h - bar	4.50
													10 FR	4550
													25 FR	3870
													30 FR	3640
													40 FR	3250
													10 DW	3220
													25 DW	2735
													30 DW	2575
40 DW	2300													

AB: Aramid Belted - SB: Steel Belted - STD: Standard

Technologies



Block Pattern

Performance



Durability



Self-Cleaning





IMPLEMENT

AW 726

Ø 17"	Tire size	RIM		S.W. (mm)	O.D. (mm)	SLR (mm)	RC (mm)	Version	PR	Type	LI/SS Drive Wheel	LI/SS Free Rolling	Load capacity (kg/tire)	
		Rec.	Alt.										km/h - bar	2.00
	420/55 - 17	13.00	-	415	890	392	2584	STD	-	TL	121 A8	133 A8	10 FR	2885
													25 FR	2450
													30 FR	2305
													40 FR	2060
													10 DW	2030
													25 DW	1725
													30 DW	1625
													40 DW	1450

STD: Standard

Technologies



Block Pattern

Performance



Durability



Self-Cleaning





IMPLEMENT

Bias



AW 729

AW 729 is an agricultural tire specifically designed for transport, hay harvesting, baling and soil tillage applications. Its rounded shoulder and three central grooves tread design provide low soil compaction and avoids damages to the field. AW 729 is the ideal tire for modern farming, and it is suited for both on-and-off-the-road usage.

Ø 16"	Tire size	RIM		S.W. (mm)	O.D. (mm)	SLR (mm)	RC (mm)	Version	PR	Type	LI/SS Drive Wheel	LI/SS Free Rolling	Load capacity (kg/tire)	
		Rec.	Alt.										km/h - bar	3.20
Ø 16"	340/55 - 16 (13.0/55 - 16)	11.0	-	343	785	358	2358	STD	-	TL	121 A8	133 A8	10 FR	2885
													25 FR	2450
													30 FR	2305
													40 FR	2060
													10 DW	2030
													25 DW	1725
													30 DW	1625
													40 DW	1450
Ø 17"	15.0/55 - 17	13.00	13; W 13	385	850	377	2560	STD	10	TL	122 A8	134 A8	km/h - bar	2.60
													10 FR	2970
													25 FR	2520
													30 FR	2375
													40 FR	2120
													10 DW	2100
													25 DW	1785
													30 DW	1680
	40 DW	1500												
	380/55 - 17	13.00	13; W 13	385	850	377	2560	STD	-	TL	122 A8	134 A8	km/h - bar	2.60
													10 FR	2970
													25 FR	2520
													30 FR	2375
													40 FR	2120
													10 DW	2100
													25 DW	1785
30 DW													1680	
40 DW	1500													
480/45 - 17	16.00	-	480	866	400	2526	STD	-	TL	134 A8	146 A8	km/h - bar	3.20	
												10 FR	4200	
												25 FR	3570	
												30 FR	3360	
												40 FR	3000	
												10 DW	2970	
												25 DW	2525	
												30 DW	2375	
40 DW	2120													

STD: Standard

Performance



Durability



On/Off Road



Reduced Soil Compaction



Self-Cleaning





IMPLEMENT

AW 729

Ø 17"	Tire size	RIM		S.W. (mm)	O.D. (mm)	SLR (mm)	RC (mm)	Version	PR	Type	LI/SS Drive Wheel	LI/SS Free Rolling	Load capacity (kg/tire)	
		Rec.	Alt.										km/h - bar	
	500/50 - 17	16.00	-	500	945	426	2885	STD	-	TL	137A8	149A8		2.80
													10 FR	4550
													25 FR	3870
													30 FR	3640
													40 FR	3250
													10 DW	3220
													25 DW	2735
													30 DW	2575
													40 DW	2300

STD: Standard

Performance



Durability



On/Off Road



Reduced Soil Compaction



Self-Cleaning



IMPLEMENT

Bias

TERRA TRAX



TERRA TRAX has been specially designed for fodder and feeder implement. It is best suited for both on-and-off-the-road usage. TERRA TRAX shows excellent road performance, driving comfort and self-cleaning features. The low rolling resistance contributes to better fuel economy.

Ø 17.5"	Tire size	RIM		S.W. (mm)	O.D. (mm)	SLR (mm)	RC (mm)	Version	PR	Type	LI/SS	Load capacity (kg/tire)	
		Rec.	Alt.									km/h - bar	
	400/45L - 17.5	14.00	-	398	785	361	2370	STD	14	TL	156 A8	40	6.00 4000

STD: Standard

Performance





IMPLEMENT

Bias



AW 909

AW 909 has been developed for soil tillage, hay harvesting and transport applications with implement machinery, trailers and balers. It is ideal for modern farming both on and off the road.

Ø 12"	Tire size	RIM		S.W. (mm)	O.D. (mm)	SLR (mm)	RC (mm)	Version	PR	Type	LI/SS Free Rolling	Load capacity (kg/tire)	
		Rec.	Alt.									km/h - bar	
Ø 12"	10.0/75 - 12	9.00	7.0	264	710	313	2080	STD	8	TL	116 A8	3.10	
												10 FR	1750
												25 FR	1490
												30 FR	1400
	10.0/80 - 12	9.00	7.0	264	710	313	2080	STD	8	TL	116 A8	3.10	
												10 FR	1750
												25 FR	1490
												30 FR	1400
	10.0/80 - 12	9.00	7.0	264	710	313	2080	STD	10	TL	121 A8	3.90	
												10 FR	2030
												25 FR	1725
												30 FR	1625
Ø 15.3"	10.0/75 - 15.3	9.00	-	274	760	343	2227	STD	12	TL	126 A8	4.70	
												10 FR	2380
												25 FR	2025
												30 FR	1905
	10.0/75 - 15.3	9.00	-	274	760	343	2227	STD	14	TL	130 A8	5.50	
												10 FR	2660
												25 FR	2260
												30 FR	2130
	10.0/75 - 15.3	9.00	-	274	760	343	2227	STD	18	TL	135 A8	7.10	
												10 FR	3050
												25 FR	2595
												30 FR	2440
	10.0/75 - 15.3	9.00	-	274	760	343	2227	STD	10	TL	123 A8	3.90	
												10 FR	2170
												25 FR	1845
												30 FR	1735
	11.5/80 - 15.3	9.00	-	300	844	370	2473	STD	10	TL	131 A8	3.40	
												10 FR	2730
												25 FR	2320
												30 FR	2185
												40 FR	1950

Performance



Handling and Comfort

STD: Standard



AW 909

Ø 15.3"	Tire size	RIM		S.W. (mm)	O.D. (mm)	SLR (mm)	RC (mm)	Version	PR	Type	LI/SS Free Rolling	Load capacity (kg/tire)		
		Rec.	Alt.									km/h - bar		
11.5/80 - 15.3	9.00	-	300	844	370	2473	STD	12	TL	135 A8		4.10		
												10 FR	3050	
												25 FR	2595	
												30 FR	2440	
11.5/80 - 15.3	9.00	-	300	844	370	2473	STD	14	TL	139 A8		4.75		
												10 FR	3400	
												25 FR	2890	
												30 FR	2720	
11.5/80 - 15.3	9.00	-	300	844	370	2473	STD	16	TT	141 A8		5.40		
												10 FR	3605	
												25 FR	3065	
												30 FR	2885	
11.5/80 - 15.3	13.00	-	300	844	370	2473	STD	16	TL	141 A8		3.60		
												10 FR	3605	
												25 FR	3065	
												30 FR	2885	
11.5/80 - 15.3	9.00	-	300	844	370	2473	STD	18	TL	143 A8		6.10		
												10 FR	3815	
												25 FR	3245	
												30 FR	3050	
12.5/80 - 15.3	9.00	-	312	889	387	2593	STD	14	TL	142 A8		4.30		
												10 FR	3710	
												25 FR	3155	
												30 FR	2970	
Ø 17"	15.0/55 - 17	13.00	13	391	850	377	2490	STD	10	TL	134 A8		2.60	
													10 FR	2970
													25 FR	2525
													30 FR	2375
15.0/55 - 17	13.00	13	391	850	377	2490	STD	12	TL	138 A8		3.10		
												10 FR	3305	
												25 FR	2810	
												30 FR	2645	
15.0/55 - 17	13.00	13	391	850	377	2490	STD	14	TL	141 A8		3.60		
												10 FR	3605	
												25 FR	3065	
												30 FR	2885	
15.0/55 - 17	13.00	13	391	850	377	2490	STD	14	TL	141 A8		3.60		
												10 FR	3605	
												25 FR	3065	
												30 FR	2885	
15.0/55 - 17	13.00	13	391	850	377	2490	STD	14	TL	141 A8		3.60		
												10 FR	3605	
												25 FR	3065	
												30 FR	2885	

Performance



Handling and Comfort

STD: Standard



IMPLEMENT

Bias



AW 09

AW 09 has been developed for soil tillage, hay harvesting and transport applications with implements, balers and trailers. It is ideal for modern farming both on and off the road. Its reinforced carcass ensures high load capacity and a longer service tire life. AW 09 has been designed with a special cut-and-chip-resistant compound that provides extraordinary stubble resistance.

Ø 15.3"	Tire size	RIM		S.W. (mm)	O.D. (mm)	SLR (mm)	RC (mm)	Version	PR	Type	LI/SS Drive Wheel	LI/SS Free Rolling	Load capacity (kg/tire)	
		Rec.	Alt.										km/h - bar	
260/70 - 15.3	9.00	-	268	753	335	2206	STD	-	TL	110A8	122A8	km/h - bar	3.20	
												10 FR	2100	
												25 FR	1785	
												30 FR	1680	
												40 FR	1500	
												10 DW	1485	
												25 DW	1260	
30 DW	1185													
40 DW	1060													
260/70 - 15.3	9.00	-	268	753	335	2206	STD	-	TL	114A8	126A8	km/h - bar	3.60	
												10 FR	2380	
												25 FR	2025	
												30 FR	1905	
												40 FR	1700	
												10 DW	1650	
												25 DW	1405	
30 DW	1320													
40 DW	1180													
260/70 - 15.3	9.00	-	268	753	335	2206	STD	-	TL	119A8	131A8	km/h - bar	5.00	
												10 FR	2730	
												25 FR	2320	
												30 FR	2185	
												40 FR	1950	
												10 DW	1905	
												25 DW	1620	
30 DW	1525													
40 DW	1360													
300/80 - 15.3	9.00	-	295	860	376	2520	STD	-	TL	129A8	141A8	km/h - bar	4.00	
												10 FR	3605	
												25 FR	3065	
												30 FR	2885	
												40 FR	2575	
												10 DW	2590	
												25 DW	2200	
30 DW	2070													
40 DW	1850													

STD: Standard

Technologies



Performance





Ø 15.3"	Tire size	RIM		S.W. (mm)	O.D. (mm)	SLR (mm)	RC (mm)	Version	PR	Type	LI/SS Drive Wheel	LI/SS Free Rolling	Load capacity (kg/tire)	
		Rec.	Alt.										km/h - bar	
300/80 - 15.3	9.00	-	295	860	376	2520	STD	-	TL	120 A8	132 A8	2.80		
												10 FR	2800	
												25 FR	2380	
												30 FR	2240	
												40 FR	2000	
												10 DW	1960	
												25 DW	1665	
												30 DW	1570	
40 DW	1400													
300/80 - 15.3	9.00	-	295	860	376	2520	STD	-	TL	126 A8	138 A8	3.60		
												10 FR	3305	
												25 FR	2810	
												30 FR	2645	
												40 FR	2360	
												10 DW	2380	
												25 DW	2025	
												30 DW	1905	
40 DW	1700													
320/80 - 15.3	9.00	-	309	901	392	2640	STD	-	TL	133 A8	145 A8	4.00		
												10 FR	4060	
												25 FR	3450	
												30 FR	3250	
												40 FR	2900	
												10 DW	2885	
												25 DW	2450	
												30 DW	2305	
40 DW	2060													
Ø 15.5"	400/60 - 15.5	AG 13.00	-	404	874	382	2561	STD	-	TL	132 A8	145 A8	3.60	
													10 FR	4060
													25 FR	3450
													30 FR	3250
													40 FR	2900
													10 DW	2800
													25 DW	2380
													30 DW	2240
40 DW	2000													
Ø 17"	380/55 - 17	13.00	-	390	850	377	2491	STD	-	TL	125 A8	138 A8	2.80	
													10 FR	3305
													25 FR	2810
													30 FR	2645
													40 FR	2360
													10 DW	2310
													25 DW	1965
													30 DW	1850
40 DW	1650													

STD: Standard

Technologies



Special Compound

Performance



Cut and Chip Resistance



Durability



High Load Capacity



Stubble Resistance





IMPLEMENT

AW 09

Ø 17"	Tire size	RIM		S.W. (mm)	O.D. (mm)	SLR (mm)	RC (mm)	Version	PR	Type	LI/SS Drive Wheel	LI/SS Free Rolling	Load capacity (kg/tire)	
		Rec.	Alt.										km/h - bar	3.20
	380/55 - 17	13.00	-	390	850	377	2491	STD	-	TL	128 A8	141 A8	10 FR	3605
													25 FR	3065
													30 FR	2885
													40 FR	2575
													10 DW	2520
													25 DW	2140
													30 DW	2015
													40 DW	1800

STD: Standard

Technologies



Special Compound

Performance



Cut and Chip Resistance



Durability



High Load Capacity



Stubble Resistance





IMPLEMENT

Bias

AW - 18



AW-18 has been designed for trailers and implement machinery employed in soil tillage operations. Its special design with non-directional lugs and a rounded shoulder area avoids crop damages while maneuvering. The tread pattern has been specifically developed to ensure top self-cleaning properties. AW-18 also stands for best driving comfort and reduced fuel consumption.

Ø 15.3"	Tire size	RIM		S.W. (mm)	O.D. (mm)	SLR (mm)	RC (mm)	Version	PR	Type	LI/SS Drive Wheel	LI/SS Free Rolling	Load capacity (kg/tire)		
		Rec.	Alt.										km/h - bar		
														4.75	
	11.5/80 - 15.3 (300/80 - 15.3)	9.00	-	297	845	-	-	STD	-	TL	-	139A8		10 FR	3400
														25 FR	2890
														30 FR	2720
														40 FR	2430

STD: Standard

Technologies



Performance





IMPLEMENT

Bias



BK 4040

BK 4040 has been specifically designed for agricultural trailers in haulage application. The strong casing ensures best load capacity and durability.

Ø 16"	Tire size	RIM		S.W. (mm)	O.D. (mm)	SLR (mm)	RC (mm)	Version	PR	Type	LI/SS	Load capacity (kg/tire)	
		Rec.	Alt.									km/h - bar	
6.50 - 16	4.50 E	-	182	740	-	-	STD	10	TT	-	30	4.10	1010
7.00 - 16	5.50	5.00 F	198	770	-	-	STD	12	TT	-	30	4.70	1320

Performance



Durability



High Load Capacity

STD: Standard





IMPLEMENT

Bias



RIB IMPLEMENT (A)

RIB IMPLEMENT (A) has been engineered for trailers and implement machinery in transport and soil tillage applications. It is ideal for modern farming and shows top performance both on and off the road. RIB IMPLEMENT (A) is the right choice for all operating conditions which require a high level of handling as well as reduced soil compaction to preserve the crops.

Ø 12"	Tire size	RIM		S.W. (mm)	O.D. (mm)	SLR (mm)	RC (mm)	Version	PR	Type	LI/SS Free Rolling	Load capacity (kg/tire)		
		Rec.	Alt.									km/h - bar		
													2.30	
	10.0/80 - 12	9.00	7.0	264	746	329	2186	STD	6	TL	110 A8		1485	
													1260	
													1185	
													1060	

STD: Standard

Performance



Bias



IMPLEMENT



RIB IMPLEMENT (B)

RIB IMPLEMENT (B) has been specially designed for agricultural implements. This ideal tire for modern farming is made of a stubble-resistant compound providing excellent puncture protection. RIB IMPLEMENT (B) is a 5-rib tread pattern tire featuring a strong casing for a longer service life. It is the right choice for all operating conditions, which require high load capacity along with low rolling resistance.

Ø 17"	Tire size	RIM		S.W. (mm)	O.D. (mm)	SLR (mm)	RC (mm)	Version	PR	Type	LI/SS Drive Wheel	LI/SS Free Rolling	Load capacity (kg/tire)		
		Rec.	Alt.										km/h - bar		
														4.0	
	49 - 17	13.0	14.0	425	1200	-	-	STD	20	TT	146 A8/143 B	158 A8/154 B		4250	
														3750	
														3000	
														2725	

STD: Standard

Performance





IMPLEMENT

Radial



RIB 713 (I-1)

RIB 713 is a steel-belted tire for agricultural implements. As a response to the increasing awareness of low soil compaction in modern farming, RIB 713 has been designed with IF technology. This enables the tire to carry heavier loads at lower inflation pressures and provides a larger footprint with uniform weight distribution. The steel-belted structure provides excellent puncture resistance and hence increased protection against stub penetration and relative damage, even if running into strong stubble. In addition, "D" speed rating (65 km/h - 40 mph) allows for fast road transfers. RIB 713 is BKT's contribution to maximize both the productivity and efficiency of your farming business

Ø 15"	Tire size	LI/SS	RIM		S.W. (mm)	O.D. (mm)	SLR (mm)	RC (mm)	SRI (index)	Version	Load capacity (kg/tire)											
			Rec.	Alt.							km/h - bar											
											0.8	1.2	1.6	2.0	2.4	2.8	3.2	3.6	4.0	5.0		
IF 240/80 R 15	129 D	W 8	-	240	765	354	2324	360	SR	From 10 to 65	540	685	835	945	1095	1240	1370	1500	1650	1850		
										km/h - bar	0.8	1.2	1.6	2.0	2.4	2.8	3.2	3.6	4.0	5.0		
IF 265/85 R 15 (10.5L R15)	121 D	W 8	-	260	831	368	2502	390	SR	From 10 to 65	700	900	1105	1265	1450							
										km/h - bar	0.8	1.2	1.6	2.0	2.4							
IF 280/70 R 15	128 D	W 8	-	279	779	347	2356	360	SR	From 10 to 65	670	775	885	1010	1120	1225	1335	1425	1570	1695	1800	
										km/h - bar	0.6	0.8	1.0	1.2	1.4	1.6	2.0	2.4	2.8	3.2	3.6	
IF 280/70 R 15	134 D	W 8	-	279	779	347	2356	360	SR	From 10 to 65	775	885	1010	1120	1225	1335	1425	1570	1695	1800	1995	2120
										km/h - bar	0.8	1.0	1.2	1.4	1.6	2.0	2.4	2.8	3.2	3.6	4.0	4.4
IF 320/70 R 15	146 D	W10	-	320	823	367	2590	390	SR	From 10 to 65	855	1090	1325	1500	1735	1970	2175	2380	2615	2935	3000	
										km/h - bar	0.8	1.2	1.6	2.0	2.4	2.8	3.2	3.6	4.0	5.0	5.2	

SR: Stubble Resistant

Technologies



High Speed



IF Technology



Steel Belted

Performance



Durability



Fuel Economy



High Load Capacity



Stubble Resistance





IMPLEMENT

Bias



RIB 774 (A)

RIB 774 (A) is a low-section implement tire offering high load capacity and a long tire life-cycle. It is suitable for hay harvesting and transport applications with balers and trailers.

Ø 8"	Tire size	RIM		S.W. (mm)	O.D. (mm)	SLR (mm)	RC (mm)	Version	PR	Type	LI/SS Free Rolling	Load capacity (kg/tire)	
		Rec.	Alt.									km/h - bar	3.00
Ø 8"	18 X 8.50 - 8	7.00 -55 ; -70 ; -90	-	225	460	217	1390	STD	6	TL	85 A8	10 FR	720
												25 FR	615
												30 FR	575
												40 FR	515
	18 X 8.50 - 8	7.00 -55 ; -70 ; -90	-	225	460	217	1390	AB	6	TL	85 A8	10 FR	720
												25 FR	615
												30 FR	575
												40 FR	515
Ø 14.5"	200/60 - 14.5	AG 6.75	-	210	610	288	1888	STD	10	TT	106 A8	10 FR	1330
												25 FR	1130
												30 FR	1065
												40 FR	950
	200/60 - 14.5	AG 6.75	-	210	610	288	1888	STD	10	TL	106 A8	10 FR	1330
												25 FR	1130
												30 FR	1065
												40 FR	950
	200/60 - 14.5	AG 6.75	-	210	610	288	1888	STD	14	TT	113 A8	10 FR	1610
												25 FR	1370
												30 FR	1290
												40 FR	1150
	200/60 - 14.5	AG 6.75	-	210	610	288	1888	STD	14	TL	113 A8	10 FR	1610
												25 FR	1370
												30 FR	1290
												40 FR	1150
	200/60 - 14.5	AG 6.75	-	210	610	288	1888	HD	10	TT	106 A8	10 FR	1330
												25 FR	1130
												30 FR	1065
												40 FR	950
	250/65 - 14.5	AG 8.00	6.75	255	690	303	1978	STD	12	TL	119 A8	10 FR	1905
												25 FR	1620
												30 FR	1525
												40 FR	1360

Performance



Durability



High Load Capacity

STD: Standard - HD: Heavy Duty - AB: Aramid Belted



RIB 774 (A)

Ø 14.5"	Tire size	RIM		S.W. (mm)	O.D. (mm)	SLR (mm)	RC (mm)	Version	PR	Type	LI/SS Free Rolling	Load capacity (kg/tire)	
		Rec.	Alt.									km/h - bar	
Ø 14.5"	250/65 - 14.5	AG 8.00	6.75	255	690	303	1978	STD	14	TL	124 A8	5.50	
												10 FR	2240
												25 FR	1905
												30 FR	1790
												40 FR	1600
Ø 16"	10.5/65 - 16	W 9	W 8 L	265	745	339	2183	STD	14	TT	130 A8	5.30	
												10 FR	2660
												25 FR	2260
												30 FR	2130
												40 FR	1900
Ø 16"	10.5/65 - 16	W 9	W 8 L	265	745	339	2183	IND	14	TT	130 A8	5.30	
												10 FR	2660
												25 FR	2260
												30 FR	2130
												40 FR	1900
Ø 18"	12.0 - 18 (340/70 - 18)	11.0	-	342	902	414	2688	STD	16	TL	150 A8	5.20	
												10 FR	4690
												25 FR	3985
												30 FR	3750
												40 FR	3350

Performance



Durability



High Load Capacity

STD: Standard - IND: Industrial





IMPLEMENT

Bias



RIB 774 (B)

RIB 774 (B) is a low-section implement tire. It is ideal for modern farming and suitable for on- and off-the-road applications with implement machinery and trailers. It features great load capacity and a long tire life-cycle. An "HD" version is available for heavy-duty services.

Ø 17"	Tire size	RIM		S.W. (mm)	O.D. (mm)	SLR (mm)	RC (mm)	Version	PR	Type	LI/SS Free Rolling	Load capacity (kg/tire)	
		Rec.	Alt.									km/h - bar	
15.0/55 - 17	13.00	13	391	850	377	2490	STD	14	TL	141 A8		3.70	
												10 FR	3605
												25 FR	3065
												30 FR	2885
												40 FR	2575
15.0/55 - 17	13.00	13	391	850	377	2490	STD	10	TL	134 A8		2.60	
												10 FR	2970
												25 FR	2525
												30 FR	2375
												40 FR	2120

STD: Standard

Technologies



Special Compound

Performance



Durability



High Load Capacity





IMPLEMENT

Bias



RIB 774 (C)

RIB 774 (C) is a low-section and narrow-width implement tire. It is ideal for hay harvesting and transport applications with balers and trailers, both on- and off-the-road. It features great load capacity and a long tire life-cycle.

Ø 17"	Tire size	RIM		S.W. (mm)	O.D. (mm)	SLR (mm)	RC (mm)	Version	PR	Type	LI/SS Free Rolling	Load capacity (kg/tire)	
		Rec.	Alt.									km/h - bar	
Ø 17"	19.0/45 - 17	16.00	-	455	845	387	2518	STD	10	TL	138 A8	2.25	
												10 FR	3305
												25 FR	2810
												30 FR	2645
												40 FR	2360
Ø 17.5"	215/75 - 17.5	6.75	-	220	775	360	2310	STD	12	TL	134 A8	6.90	
												10 FR	2970
												25 FR	2525
												30 FR	2375
												40 FR	2120
	215/75 - 17.5	6.75	-	220	775	360	2310	STD	16	TL	139 A8	9.00	
												10 FR	3710
												25 FR	3155
												30 FR	2970
												40 FR	2650
	225/75 - 17.5	6.75	-	220	775	360	2310	STD	12	TL	134 A8	6.90	
												10 FR	2970
												25 FR	2525
												30 FR	2375
												40 FR	2120
	225/75 - 17.5	6.75	-	220	775	360	2310	STD	16	TL	139 A8	9.00	
												10 FR	3710
25 FR												3155	
30 FR												2970	
40 FR												2650	

STD: Standard

Performance



Durability



High Load Capacity



IMPLEMENT

Bias



RIB 775

RIB 775 is a low-section cross-ply tire for transport and soil tillage applications with trailers and implement machinery. It offers great load capacity and a long tire life-cycle.

Ø 12"	Tire size	RIM		S.W. (mm)	O.D. (mm)	SLR (mm)	RC (mm)	Version	PR	Type	LI/SS Free Rolling	Load capacity (kg/tire)	
		Rec.	Alt.									km/h - bar	
300/65 - 12	9.0	-	305	685	304	2007	STD	8	TL	116 A8		2.60	
												10 FR	1750
												25 FR	1490
												30 FR	1400
												40 FR	1250

STD: Standard

Performance



Durability



High Load Capacity



IMPLEMENT

Bias



RIB 900

RIB 900 is suitable for transport, soil tillage and hay harvesting operations with trailers, implement machinery and balers. It offers great load capacity and a long tire life-cycle.

Ø 15.5"	Tire size	RIM		S.W. (mm)	O.D. (mm)	SLR (mm)	RC (mm)	Version	PR	Type	LI/SS Free Rolling	Load capacity (kg/tire)	
		Rec.	Alt.									km/h - bar	
400/60 - 15.5	AG 13.00	-	405	875	380	2564	STD	10	TL	139 A8		2.50	
												10 FR	3135
												25 FR	2665
												30 FR	2510
												40 FR	2240
400/60 - 15.5	AG 13.00	-	405	875	380	2564	STD	14	TL	145 A8		3.60	
												10 FR	4060
												25 FR	3450
												30 FR	3250
												40 FR	2900
400/60 - 15.5	AG 13.00	-	405	875	380	2564	STD	16	TL	147 A8		4.00	
												10 FR	4305
												25 FR	3660
												30 FR	3445
												40 FR	3075

STD: Standard

Performance



Durability



High Load Capacity



IMPLEMENT

Bias



RIB MASTER

RIB MASTER is suitable for transport and hay harvesting operations with trailers, balers and implement machinery. This tire offers great load capacity and a long tire life-cycle.

Ø 17.5"	Tire size	RIM		S.W. (mm)	O.D. (mm)	SLR (mm)	RC (mm)	Version	PR	Type	LI/SS Free Rolling	Load capacity (kg/tire)	
		Rec.	Alt.									km/h - bar	
	215/75 - 17.5	6.75	-	220	775	360	2310	STD	16	TL	142 A8	9.00	
												10 FR	3710
												25 FR	3155
												30 FR	2970
												40 FR	2650

STD: Standard

Performance



Durability



High Load Capacity



IMPLEMENT

Bias



FLOTATION RIB IMPLEMENT

FLOTATION RIB IMPLEMENT is a rib pattern tire for trailers, implement and balers in transport and harvesting applications. It features high load capacity and a long tire life-cycle.

Ø 15"	Tire size	RIM		S.W. (mm)	O.D. (mm)	SLR (mm)	RC (mm)	Version	PR	Type	LI/SS	Load capacity (kg/tire)	
		Rec.	Alt.									km/h - bar	
	31 X 13.50 - 15	10 LB	-	360	780	374	2398	STD	12	TL	124 B	5.20	
												50	1600

STD: Standard

Performance



Durability



High Load Capacity



IMPLEMENT

Bias



MULTI RIB

MULTI RIB is an agro-industrial tire for soil tillage and transport applications with 2WD tractors and implement machinery. It offers excellent handling throughout its long product life-cycle. Several versions are available for every need: an "aramid belted" version with improved puncture resistance, while the "HD" is made of a special cut-and-chip resistance compound.

Ø 16"	Tire size	RIM		S.W. (mm)	O.D. (mm)	SLR (mm)	RC (mm)	Version	PR	Type	LI/SS	Load capacity (kg/tire)	
		Rec.	Alt.									km/h - bar	4.10
11.00 - 16	W10 L	W 8 ; W 8 L	315	930	-	-	STD	12	TL	-	40	1550	
11.00 - 16	W10 L	W 8 ; W 8 L	315	930	-	-	AB HD	12	TL	-	40	1550	
11.00 - 16	W10 L	W 8 ; W 8 L	315	930	-	-	HD	12	TL	-	40	1550	

STD: Standard - AB HD: Aramid Belted HD - HD: Heavy Duty

Technologies



Performance





IMPLEMENT

Bias



AS 504

AS 504 is an agro-industrial tire mainly designed for soil tillage, implement and material-handling operations. This tire, which features excellent self-cleaning properties and increased grip, is suitable for field trailers and telehandlers. AS 504 is available in several versions to meet specific end-user requirements: an "HD" version with a special cut-and-chip resistance compound, while the "special" version has a reinforced casing that ensures a longer tire life.

Ø 12"	Tire size	RIM		S.W. (mm)	O.D. (mm)	SLR (mm)	RC (mm)	Version	PR	Type	LI/SS Drive Wheel	LI/SS Free Rolling	Load capacity (kg/tire)	
		Rec.	Alt.										km/h - bar	
6.5/80 - 12	5 J	5 JA	169	608	283	1836	STD	4	TT	72 A8	84 A8	2.40		
												10 FR	700	
												25 FR	595	
												30 FR	560	
												40 FR	500	
												10 DW	495	
												25 DW	420	
												30 DW	400	
40 DW	355													
6.5/80 - 12	5 J	5 JA	169	608	283	1836	STD	4	TL	72 A8	84 A8	2.40		
												10 FR	700	
												25 FR	595	
												30 FR	560	
												40 FR	500	
												10 DW	495	
												25 DW	420	
												30 DW	400	
40 DW	355													
6.5/80 - 12	5 J	5 JA	169	608	283	1836	STD	6	TT	80 A8	93 A8	3.60		
												10 FR	910	
												25 FR	775	
												30 FR	730	
												40 FR	650	
												10 DW	630	
												25 DW	535	
												30 DW	505	
40 DW	450													
6.5/80 - 12	5 J	5 JA	169	608	283	1836	STD	6	TL	80 A8	93 A8	3.60		
												10 FR	910	
												25 FR	775	
												30 FR	730	
												40 FR	650	
												10 DW	630	
												25 DW	535	
												30 DW	505	
40 DW	450													

STD: Standard

Technologies



Heavy Duty



Reinforced Carcass



Aramid Belted

Performance



Cut and Chip Resistance



Durability



Self-Cleaning



Stability



Traction



AS 504

Ø 12"	Tire size	RIM		S.W. (mm)	O.D. (mm)	SLR (mm)	RC (mm)	Version	PR	Type	LI/SS Drive Wheel	LI/SS Free Rolling	Load capacity (kg/tire)	
		Rec.	Alt.										km/h - bar	
6.5/80 - 12	5 J	5 JA	169	608	283	1836	HD	6	TT	80 A8	93 A8	3.60		
												10 FR		910
												25 FR		775
												30 FR		730
												40 FR		650
												10 DW		630
												25 DW		535
												30 DW		505
40 DW		450												
7.00 - 12	4.5	-	187	683	300	2001	STD	6	TT	83 A8	95 A8	2.50		
												10 FR		965
												25 FR		820
												30 FR		775
												40 FR		690
												10 DW		680
												25 DW		575
												30 DW		545
40 DW		485												
7.00 - 12	4.5	-	187	683	311	2049	STD	4	TT	75 A8	88 A8	1.70		
												10 FR		785
												25 FR		665
												30 FR		625
												40 FR		560
												10 DW		540
												25 DW		460
												30 DW		430
40 DW		385												
7.00 - 12	4.5	-	187	683	311	2049	STD	4	TL	75 A8	88 A8	1.70		
												10 FR		785
												25 FR		665
												30 FR		625
												40 FR		560
												10 DW		540
												25 DW		460
												30 DW		430
40 DW		385												
7.00 - 12	4.5	-	187	683	311	2049	STD	6	TL	83 A8	95 A8	2.50		
												10 FR		965
												25 FR		820
												30 FR		775
												40 FR		690
												10 DW		680
												25 DW		575
												30 DW		545
40 DW		485												

STD: Standard - HD: Heavy Duty

Technologies



Heavy Duty



Reinforced Carcass



Aramid Belted

Performance



Cut and Chip Resistance



Durability



Self-Cleaning



Stability



Traction



AS 504

Ø 12"	Tire size	RIM		S.W. (mm)	O.D. (mm)	SLR (mm)	RC (mm)	Version	PR	Type	LI/SS Drive Wheel	LI/SS Free Rolling	Load capacity (kg/tire)	
		Rec.	Alt.										km/h - bar	
7.00 - 12	4.5	-	187	683	311	2049	AB	8	TL	88 A8	100 A8	3.30		
												10 FR	1120	
												25 FR	950	
												30 FR	895	
												40 FR	800	
												10 DW	785	
												25 DW	665	
												30 DW	625	
40 DW	560													
7.00 - 12	4.5	-	187	683	311	2049	SPL	8	TL	88 A8	100 A8	3.30		
												10 FR	1120	
												25 FR	950	
												30 FR	895	
												40 FR	800	
												10 DW	785	
												25 DW	665	
												30 DW	625	
40 DW	560													
10.0/80 - 12	9.00	7.0	270	730	335	2233	STD	-	TL	109 A8	121 A8	3.90		
												10 FR	2030	
												25 FR	1725	
												30 FR	1625	
												40 FR	1450	
												10 DW	1440	
												25 DW	1225	
												30 DW	1155	
40 DW	1030													
11.0/65 - 12	9.00	-	273	700	321	2072	STD	8	TT	101 A8	114 A8	2.90		
												10 FR	1650	
												25 FR	1405	
												30 FR	1320	
												40 FR	1180	
												10 DW	1155	
												25 DW	980	
												30 DW	925	
40 DW	825													
11.0/65 - 12	9.00	-	273	700	321	2072	STD	8	TL	101 A8	114 A8	2.90		
												10 FR	1650	
												25 FR	1405	
												30 FR	1320	
												40 FR	1180	
												10 DW	1155	
												25 DW	980	
												30 DW	925	
40 DW	825													
26 X 12.00 - 12	10.50 AT	8.0 AT ; 8.5 AT ; 9.0 AT	310	648	298	1932	STD	-	TL	112 A6		3.0		
												30	1120	

Technologies



Heavy Duty



Reinforced Carcass



Aramid Belted

Performance

Cut and Chip
Resistance

Durability



Self-Cleaning



Stability



Traction

STD: Standard - SPL: Special - AB: Aramid Belted



AS 504

Ø 15"	Tire size	RIM		S.W. (mm)	O.D. (mm)	SLR (mm)	RC (mm)	Version	PR	Type	LI/SS Drive Wheel	LI/SS Free Rolling	Load capacity (kg/tire)	
		Rec.	Alt.										km/h - bar	
400/50 - 15	13 LB	-	395	790	369	2387	STD	-	TL	109 A8	121 A8	3.00		
												10 FR	2030	
												25 FR	1725	
												30 FR	1625	
												40 FR	1450	
												10 DW	1440	
												25 DW	1225	
												30 DW	1155	
40 DW	1030													
5.00 - 15	3.50 D	3.00 D ; 4.00 E ; 4 J	140	657	308	1957	STD	6	TT	75 A8	88 A8	3.50		
												10 FR	785	
												25 FR	665	
												30 FR	625	
												40 FR	560	
												10 DW	540	
												25 DW	460	
												30 DW	430	
40 DW	385													
5.00 - 15	3.50 D	3.00 D ; 4.00 E ; 4 J	140	657	308	1957	STD	6	TL	75 A8	88 A8	3.50		
												10 FR	785	
												25 FR	665	
												30 FR	625	
												40 FR	560	
												10 DW	540	
												25 DW	460	
												30 DW	430	
40 DW	385													
5.00 - 15	3.50 D	3.00 D ; 4.00 E ; 4 J	140	657	308	1957	STD	4	TT	67 A8	79 A8	230		
												10 FR	610	
												25 FR	520	
												30 FR	485	
												40 FR	435	
												10 DW	425	
												25 DW	365	
												30 DW	340	
40 DW	305													
7.5L - 15	6 LB	5 K ; 5½ J ; 5½ K	210	765	354	2280	STD	6	TT	97 A8	109 A8	3.10		
												10 FR	1440	
												25 FR	1225	
												30 FR	1155	
												40 FR	1030	
												10 DW	1020	
												25 DW	870	
												30 DW	820	
40 DW	730													

STD: Standard

Technologies



Heavy Duty



Reinforced Carcass



Aramid Belted

Performance



Cut and Chip Resistance



Durability



Self-Cleaning



Stability



Traction



AS 504

Ø 15"	Tire size	RIM		S.W. (mm)	O.D. (mm)	SLR (mm)	RC (mm)	Version	PR	Type	LI/SS Drive Wheel	LI/SS Free Rolling	Load capacity (kg/tire)		
		Rec.	Alt.										km/h - bar		
7.5L - 15	6 LB	5 K ; 5½ J ; 5½ K	210	765	354	2280	STD	8	TT	100 A8	113 A8		km/h - bar	3.70	
													10 FR	1610	
													25 FR	1370	
													30 FR	1290	
													40 FR	1150	
													10 DW	1120	
													25 DW	950	
													30 DW	895	
40 DW	800														
7.5L - 15	6 LB	5 K ; 5½ J ; 5½ K	210	765	354	2280	STD	8	TL	100 A8	113 A8		km/h - bar	3.70	
													10 FR	1610	
													25 FR	1370	
													30 FR	1290	
													40 FR	1150	
													10 DW	1120	
													25 DW	950	
													30 DW	895	
40 DW	800														
7.5L - 15	6 LB	5 K ; 5½ J ; 5½ K	210	765	354	2280	AB HD	8	TL	100 A8	113 A8		km/h - bar	3.70	
													10 FR	1610	
													25 FR	1370	
													30 FR	1290	
													40 FR	1150	
													10 DW	1120	
													25 DW	950	
													30 DW	895	
40 DW	800														
7.5L - 15	6 LB	5 K ; 5½ J ; 5½	210	765	354	2280	HD	8	TT	100 A8	113 A8		km/h - bar	3.70	
													10 FR	1610	
													25 FR	1370	
													30 FR	1290	
													40 FR	1150	
													10 DW	1120	
													25 DW	950	
													30 DW	895	
40 DW	800														
Ø 15.3"	10.0/75 - 15.3	9.00	-	264	785	360	2404	STD	8	TT	106 A8	119 A8		km/h - bar	3.10
														10 FR	1905
														25 FR	1620
														30 FR	1525
														40 FR	1360
														10 DW	1330
														25 DW	1130
														30 DW	1065
40 DW	950														

Technologies



Heavy Duty



Reinforced Carcass



Aramid Belted

Performance



Cut and Chip Resistance



Durability



Self-Cleaning



Stability



Traction

STD: Standard - AB HD: Aramid Belted HD - HD: Heavy Duty



AS 504

Ø 15.3"	Tire size	RIM		S.W. (mm)	O.D. (mm)	SLR (mm)	RC (mm)	Version	PR	Type	LI/SS Drive Wheel	LI/SS Free Rolling	Load capacity (kg/tire)	
		Rec.	Alt.										km/h - bar	
10.0/75 - 15.3	9.00	-	264	785	360	2404	STD	8	TL	106 A8	119 A8	3.10		
												10 FR		1905
												25 FR		1620
												30 FR		1525
												40 FR		1360
												10 DW		1330
												25 DW		1130
												30 DW		1065
40 DW		950												
10.0/75 - 15.3	9.00	-	264	785	360	2404	STD	10	TL	111 A8	123 A8	3.90		
												10 FR		2170
												25 FR		1845
												30 FR		1735
												40 FR		1550
												10 DW		1525
												25 DW		1295
												30 DW		1220
40 DW		1090												
10.0/75 - 15.3	9.00	-	264	785	360	2404	STD	14	TL	118 A8	130 A8	5.50		
												10 FR		2660
												25 FR		2260
												30 FR		2130
												40 FR		1900
												10 DW		1850
												25 DW		1570
												30 DW		1480
40 DW		1320												
10.0/75 - 15.3	9.00	-	264	785	360	2404	STD	18	TT	123 A8	135 A8	7.10		
												10 FR		3050
												25 FR		2595
												30 FR		2440
												40 FR		2180
												10 DW		2170
												25 DW		1845
												30 DW		1735
40 DW		1550												
10.0/75 - 15.3	9.00	-	264	785	360	2404	STD	18	TL	123 A8	135 A8	7.10		
												10 FR		3050
												25 FR		2595
												30 FR		2440
												40 FR		2180
												10 DW		2170
												25 DW		1845
												30 DW		1735
40 DW		1550												

STD: Standard

Technologies



Heavy Duty



Reinforced Carcass



Aramid Belted

Performance



Cut and Chip Resistance



Durability



Self-Cleaning



Stability



Traction



AS 504

Ø 15.3"	Tire size	RIM		S.W. (mm)	O.D. (mm)	SLR (mm)	RC (mm)	Version	PR	Type	LI/SS Drive Wheel	LI/SS Free Rolling	Load capacity (kg/tire)	
		Rec.	Alt.										km/h - bar	
10.0/75 - 15.3	9.00	-	264	785	360	2404	IND	8	TL	106 A8	119 A8	3.10		
												10 FR		1905
												25 FR		1620
												30 FR		1525
												40 FR		1360
												10 DW		1330
												25 DW		1130
												30 DW		1065
40 DW		950												
11.5/80 - 15.3	9.00	-	290	867	380	2540	STD	8	TT	114 A8	126 A8	2.70		
												10 FR		2380
												25 FR		2025
												30 FR		1905
												40 FR		1700
												10 DW		1650
												25 DW		1405
												30 DW		1320
40 DW		1180												
11.5/80 - 15.3	9.00	-	290	867	380	2540	STD	8	TL	114 A8	126 A8	2.70		
												10 FR		2380
												25 FR		2025
												30 FR		1905
												40 FR		1700
												10 DW		1650
												25 DW		1405
												30 DW		1320
40 DW		1180												
11.5/80 - 15.3	9.00	-	290	867	380	2540	STD	10	TL	119 A8	131 A8	3.40		
												10 FR		2730
												25 FR		2320
												30 FR		2185
												40 FR		1950
												10 DW		1905
												25 DW		1620
												30 DW		1525
40 DW		1360												
11.5/80 - 15.3	9.00	-	290	867	380	2540	STD	12	TT	123 A8	135 A8	4.10		
												10 FR		3050
												25 FR		2595
												30 FR		2440
												40 FR		2180
												10 DW		2170
												25 DW		1845
												30 DW		1735
40 DW		1550												

Technologies



Heavy Duty



Reinforced Carcass



Aramid Belted

Performance



Cut and Chip Resistance



Durability



Self-Cleaning



Stability



Traction

STD: Standard - IND: Industrial



AS 504

Ø 15.3"	Tire size	RIM		S.W. (mm)	O.D. (mm)	SLR (mm)	RC (mm)	Version	PR	Type	LI/SS Drive Wheel	LI/SS Free Rolling	Load capacity (kg/tire)	
		Rec.	Alt.										km/h - bar	
11.5/80 - 15.3	9.00	-	290	867	380	2540	STD	12	TL	123 A8	135 A8	4.10		
												10 FR		3050
												25 FR		2595
												30 FR		2440
												40 FR		2180
												10 DW		2170
												25 DW		1845
												30 DW		1735
40 DW		1550												
11.5/80 - 15.3	9.00	-	290	867	380	2540	STD	14	TT	126 A8	139 A8	4.80		
												10 FR		3400
												25 FR		2890
												30 FR		2720
												40 FR		2430
												10 DW		2380
												25 DW		2025
												30 DW		1905
40 DW		1700												
11.5/80 - 15.3	9.00	-	290	867	380	2540	STD	14	TL	126 A8	139 A8	4.80		
												10 FR		3400
												25 FR		2890
												30 FR		2720
												40 FR		2430
												10 DW		2380
												25 DW		2025
												30 DW		1905
40 DW		1700												
11.5/80 - 15.3	9.00	-	290	867	380	2540	SR	12	TL	123 A8	135 A8	4.10		
												10 FR		3050
												25 FR		2595
												30 FR		2440
												40 FR		2180
												10 DW		2170
												25 DW		1845
												30 DW		1735
40 DW		1550												
27 X 10 - 15.3	9.00	-	260	695	317	2071	STD	8	TL	95 A8	107 A8	3.10		
												10 FR		1365
												25 FR		1160
												30 FR		1090
												40 FR		975
												10 DW		965
												25 DW		820
												30 DW		775
40 DW		690												

Technologies



Heavy Duty



Reinforced Carcass



Aramid Belted

Performance



Cut and Chip Resistance



Durability



Self-Cleaning



Stability



Traction

STD: Standard - SR: Stubble Resistant





AS 504

Ø 15.3"	Tire size	RIM		S.W. (mm)	O.D. (mm)	SLR (mm)	RC (mm)	Version	PR	Type	LI/SS Drive Wheel	LI/SS Free Rolling	Load capacity (kg/tire)		
		Rec.	Alt.										km/h - bar		
														3.10	
	27 X 10 - 15.3	9.00	-	260	695	317	2071	STD	8	TT	95 A8	107 A8	10 FR	1365	
													25 FR	1160	
													30 FR	1090	
													40 FR	975	
													10 DW	965	
													25 DW	820	
													30 DW	775	
													40 DW	690	
													km/h - bar	3.90	
													10 FR	2170	
													25 FR	1845	
													30 FR	1735	
													40 FR	1550	
													10 DW	1525	
													25 DW	1295	
													30 DW	1220	
													40 DW	1090	
													km/h - bar	2.80	
													10 FR	595	
													25 FR	505	
													30 FR	475	
													40 FR	425	
													10 DW	420	
													25 DW	355	
													30 DW	335	
													40 DW	300	
													km/h - bar	2.80	
													10 FR	965	
													25 FR	820	
													30 FR	775	
													40 FR	690	
													10 DW	680	
													25 DW	575	
													30 DW	545	
													40 DW	485	
													km/h - bar	2.80	
													10 FR	965	
													25 FR	820	
													30 FR	775	
													40 FR	690	
													10 DW	680	
													25 DW	575	
													30 DW	545	
													40 DW	485	

Technologies



Heavy Duty



Reinforced Carcass



Aramid Belted

Performance



Cut and Chip Resistance



Durability



Self-Cleaning



Stability



Traction

STD: Standard - HD: Heavy Duty



AS 504

Ø 16"	Tire size	RIM		S.W. (mm)	O.D. (mm)	SLR (mm)	RC (mm)	Version	PR	Type	LI/SS Drive Wheel	LI/SS Free Rolling	Load capacity (kg/tire)	
		Rec.	Alt.										km/h - bar	
6.00 - 16	4.00 E 4.50 E ; 4½ K	164	735	343	2190	HD	8	TT	91 A8	103 A8	4.00			
											10 FR	1225		
											25 FR	1040		
											30 FR	980		
											40 FR	875		
											10 DW	860		
											25 DW	730		
											30 DW	690		
40 DW	615													
7.50 - 16	5.50 F 4.50 E ; 5.00 F ; 4.00 E ; 5 K ; 6 LB ; 6.00 F	209	803	372	2475	STD	8	TL	99 A8	112 A8	3.20			
											10 FR	1570		
											25 FR	1335		
											30 FR	1255		
											40 FR	1120		
											10 DW	1085		
											25 DW	920		
											30 DW	870		
40 DW	775													
7.50 - 16	5.50 F 4.50 E ; 5.00 F ; 4.00 E ; 5 K ; 6 LB ; 6.00 F	209	803	372	2475	STD	6	TT	92 A8	104 A8	2.30			
											10 FR	1260		
											25 FR	1070		
											30 FR	1010		
											40 FR	900		
											10 DW	880		
											25 DW	750		
											30 DW	705		
40 DW	630													
7.50 - 16	5.50 F 4.50 E ; 5.00 F ; 4.00 E ; 5 K ; 6 LB ; 6.00 F	209	803	372	2475	STD	8	TT	99 A8	112 A8	3.20			
											10 FR	1570		
											25 FR	1335		
											30 FR	1255		
											40 FR	1120		
											10 DW	1085		
											25 DW	920		
											30 DW	870		
40 DW	775													
7.50 - 16	5.50 F 4.50 E ; 5.00 F ; 4.00 E ; 5 K ; 6 LB ; 6.00 F	209	803	372	2475	HD	8	TT	99 A8	112 A8	3.20			
											10 FR	1570		
											25 FR	1335		
											30 FR	1255		
											40 FR	1120		
											10 DW	1085		
											25 DW	920		
											30 DW	870		
40 DW	775													

STD: Standard - HD: Heavy Duty

Technologies



Heavy Duty



Reinforced Carcass



Aramid Belted

Performance

Cut and Chip
Resistance

Durability



Self-Cleaning



Stability



Traction



AS 504

Ø 16"	Tire size	RIM		S.W. (mm)	O.D. (mm)	SLR (mm)	RC (mm)	Version	PR	Type	LI/SS Drive Wheel	LI/SS Free Rolling	Load capacity (kg/tire)	
		Rec.	Alt.										km/h - bar	
9.0/70 - 16 (230/70 - 16)	W 7	-	222	760	355	2285	STD	10	TL	106 A8	119 A8	4.40		
												10 FR	1905	
												25 FR	1620	
												30 FR	1525	
												40 FR	1360	
												10 DW	1330	
												25 DW	1130	
												30 DW	1065	
40 DW	950													
Ø 17"	15.0/55 - 17	13.00	13	380	890	395	2608	STD	10	TL	122 A8	134 A8	2.60	
													10 FR	2970
													25 FR	2525
													30 FR	2375
													40 FR	2120
													10 DW	2100
													25 DW	1785
													30 DW	1680
40 DW	1500													
15.0/55 - 17	13.00	13	380	890	395	2608	STD	14	TL	128 A8	141 A8	3.60		
												10 FR	3605	
												25 FR	3065	
												30 FR	2885	
												40 FR	2575	
												10 DW	2520	
												25 DW	2140	
												30 DW	2010	
40 DW	1800													
19.0/45 - 17	16.00	-	465	865	389	2578	STD	14	TL	131 A8	144 A8	2.80		
												10 FR	3920	
												25 FR	3330	
												30 FR	3135	
												40 FR	2800	
												10 DW	2730	
												25 DW	2320	
												30 DW	2185	
40 DW	1950													
19.0/45 - 17	16.00	-	465	865	389	2578	STD	16	TL	134 A8	147 A8	3.10		
												10 FR	4305	
												25 FR	3660	
												30 FR	3445	
												40 FR	3075	
												10 DW	2970	
												25 DW	2525	
												30 DW	2375	
40 DW	2120													

STD: Standard

Technologies



Heavy Duty



Reinforced Carcass



Aramid Belted

Performance



Cut and Chip Resistance



Durability



Self-Cleaning



Stability



Traction



AS 504

Ø 17"	Tire size	RIM		S.W. (mm)	O.D. (mm)	SLR (mm)	RC (mm)	Version	PR	Type	LI/SS Drive Wheel	LI/SS Free Rolling	Load capacity (kg/tire)	
		Rec.	Alt.										km/h - bar	
420/55 - 17	13.00	-	430	910	407	2712	STD	14	TL	129 A8	142 A8	3.00		
												10 FR	3710	
												25 FR	3155	
												30 FR	2970	
												40 FR	2650	
												10 DW	2590	
												25 DW	2200	
30 DW	2070													
40 DW	1850													
420/55 - 17	13.00	-	430	910	407	2712	STD	16	TL	133 A8	145 A8	3.50		
												10 FR	4060	
												25 FR	3450	
												30 FR	3250	
												40 FR	2900	
												10 DW	2885	
												25 DW	2450	
30 DW	2305													
40 DW	2060													
Ø 18"	7.50 - 18	5.50 F	4.50 E ; 6.00 F ; 5.00 F	209	854	407	2649	STD	6	TT	94 A8	106 A8	2.30	
													10 FR	1330
													25 FR	1130
													30 FR	1065
													40 FR	950
													10 DW	940
													25 DW	795
													30 DW	750
													40 DW	670
													7.50 - 18	5.50 F
10 FR	1650													
25 FR	1405													
30 FR	1320													
40 FR	1180													
10 DW	1155													
25 DW	980													
30 DW	925													
40 DW	825													
7.50 - 18	5.50 F	4.50 E ; 6.00 F ; 5.00 F	209	854	407	2649	STD	12	TT	111 A8	122 A8	5.10		
												10 FR	2100	
												25 FR	1785	
												30 FR	1680	
												40 FR	1500	
												10 DW	1525	
												25 DW	1295	
												30 DW	1220	
												40 DW	1090	

STD: Standard

Technologies



Heavy Duty



Reinforced Carcass



Aramid Belted

Performance



Cut and Chip Resistance



Durability



Self-Cleaning



Stability



Traction



AS 504

Ø 18"	Tire size	RIM		S.W. (mm)	O.D. (mm)	SLR (mm)	RC (mm)	Version	PR	Type	LI/SS Drive Wheel	LI/SS Free Rolling	Load capacity (kg/tire)	
		Rec.	Alt.										km/h - bar	
10.5/80 - 18	W 9	9 ; W 8	274	907	427	2790	STD	10	TL	119 A8	131 A8		3.70	
													10 FR	2730
													25 FR	2320
													30 FR	2185
													40 FR	1950
													10 DW	1905
													25 DW	1620
													30 DW	1525
40 DW	1360													
12.5/80 - 18	W 9	9 ; 11	308	987	438	2892	STD	12	TL	129 A8	142 A8		3.70	
													10 FR	3710
													25 FR	3155
													30 FR	2970
													40 FR	2650
													10 DW	2590
													25 DW	2200
													30 DW	2070
40 DW	1850													
12.5/80 - 18	W 9	9 ; 11	308	987	438	2892	STD	16	TL	135 A8	148 A8		4.90	
													10 FR	4410
													25 FR	3750
													30 FR	3530
													40 FR	3150
													10 DW	3050
													25 DW	2595
													30 DW	2440
40 DW	2180													
12.5/80 - 18	W 9	9 ; 11	308	987	438	2892	STD	18	TL	138 A8	150 A8		5.50	
													10 FR	4690
													25 FR	3985
													30 FR	3750
													40 FR	3350
													10 DW	3305
													25 DW	2810
													30 DW	2645
40 DW	2360													
12.5/80 - 18	W 9	9 ; 11	308	987	438	2892	SPL	12	TL	129 A8	142 A8		3.70	
													10 FR	3710
													25 FR	3155
													30 FR	2970
													40 FR	2650
													10 DW	2590
													25 DW	2200
													30 DW	2070
40 DW	1850													

Technologies



Heavy Duty



Reinforced Carcass



Aramid Belted

Performance



Cut and Chip Resistance



Durability



Self-Cleaning



Stability



Traction

STD: Standard - SPL: Special



AS 504

Ø 20"	Tire size	RIM		S.W. (mm)	O.D. (mm)	SLR (mm)	RC (mm)	Version	PR	Type	LI/SS Drive Wheel	LI/SS Free Rolling	Load capacity (kg/tire)	
		Rec.	Alt.										km/h - bar	
7.50 - 20	5.50 F	4.50 E ; 6.00 F ; 5.00 F	209	904	422	2695	STD	8	TT	103 A8	116 A8		km/h - bar	3.20
													10 FR	1750
													25 FR	1490
													30 FR	1400
													40 FR	1250
													10 DW	1225
													25 DW	1040
													30 DW	980
40 DW	875													
16.0/70 - 20	13	12 SDC ; 14 ; 13 SDC	418	1097	487	3214	STD	14	TL	142 A8	154 A8		km/h - bar	3.50
													10 FR	5250
													25 FR	4465
													30 FR	4200
													40 FR	3750
													10 DW	3710
													25 DW	3155
													30 DW	2970
40 DW	2650													
16.0/70 - 20	13	12 SDC ; 14 ; 13 SDC	418	1097	487	3214	STD	16	TL	144 A8	156 A8		km/h - bar	4.00
													10 FR	5600
													25 FR	4760
													30 FR	4480
													40 FR	4000
													10 DW	3920
													25 DW	3330
													30 DW	3135
40 DW	2800													
16.0/70 - 20	13	12 SDC ; 14 ; 13 SDC	418	1097	487	3214	STD	10	TL	135 A8	147 A8		km/h - bar	2.50
													10 FR	4305
													25 FR	3660
													30 FR	3445
													40 FR	3075
													10 DW	3050
													25 DW	2595
													30 DW	2440
40 DW	2180													
16.0/70 - 20	13	12 SDC ; 14 ; 13 SDC	418	1097	487	3214	STD	12	TL	139 A8	151 A8		km/h - bar	3.00
													10 FR	4830
													25 FR	4105
													30 FR	3865
													40 FR	3450
													10 DW	3400
													25 DW	2890
													30 DW	2720
40 DW	2430													
400/70 - 20	13	12 SDC ; 14 ; 13 SDC	408	1097	487	3214	IND	-	TL	149 A8			km/h - bar	4.00
													10	4060
													25	3445
													30	3380
												40	3250	

Technologies



Heavy Duty



Reinforced Carcass



Aramid Belted

Performance



Cut and Chip Resistance



Durability



Self-Cleaning



Stability



Traction



Traction



Traction



Traction



Traction



Traction

STD: Standard - IND: Industrial



AS 504

Ø 24"	Tire size	RIM		S.W. (mm)	O.D. (mm)	SLR (mm)	RC (mm)	Version	PR	Type	LI/SS Drive Wheel	LI/SS Free Rolling	Load capacity (kg/tire)	
		Rec.	Alt.										km/h - bar	
15.5/80 - 24	W 12	W 13 ; W 14 L	384	1262	570	3875	STD	14	TL	148 A8	160 A8		3.50	
													10 FR	6300
													25 FR	5355
													30 FR	5040
													40 FR	4500
													10 DW	4410
													25 DW	3750
													30 DW	3530
40 DW	3150													
15.5/80 - 24	W 12	W 13 ; W 14 L	384	1262	570	3875	STD	16	TL	151 A8	163 A8		4.00	
													10 FR	6825
													25 FR	5800
													30 FR	5460
													40 FR	4875
													10 DW	4830
													25 DW	4105
													30 DW	3865
40 DW	3450													
15.5/80 - 24	W 12	W 13 ; W 14 L	384	1262	570	3875	STD	10	TL	142 A8	154 A8		2.50	
													10 FR	5250
													25 FR	4465
													30 FR	4200
													40 FR	3750
													10 DW	3710
													25 DW	3155
													30 DW	2970
40 DW	2650													
15.5/80 - 24	W 12	W 13 ; W 14 L	384	1262	570	3875	STD	12	TL	145 A8	157 A8		3.00	
													10 FR	5775
													25 FR	4910
													30 FR	4620
													40 FR	4125
													10 DW	4060
													25 DW	3450
													30 DW	3250
40 DW	2900													
15.5/80 - 24	W 12	W 13 ; W 14 L	384	1262	570	3875	SPL	14	TL	148 A8	160 A8		3.50	
													10 FR	6300
													25 FR	5355
													30 FR	5040
													40 FR	4500
													10 DW	4410
													25 DW	3750
													30 DW	3530
40 DW	3150													

STD: Standard - SPL: Special

Technologies



Heavy Duty



Reinforced Carcass



Aramid Belted

Performance



Cut and Chip Resistance



Durability



Self-Cleaning



Stability



Traction



AS 504

Ø 24"	Tire size	RIM		S.W. (mm)	O.D. (mm)	SLR (mm)	RC (mm)	Version	PR	Type	LI/SS Drive Wheel	LI/SS Free Rolling	Load capacity (kg/tire)	
		Rec.	Alt.										km/h - bar	
16.5/85 - 24	W 13	W 14 L; W 15 L	415	1325	591	3837	STD	16	TT	155 A8	168 A8	km/h - bar	3.80	
												10 FR	7840	
												25 FR	6665	
												30 FR	6270	
												40 FR	5600	
												10 DW	5425	
												25 DW	4610	
												30 DW	4340	
40 DW	3875													
16.5/85 - 24	W 13	W 14 L; W 15 L	415	1325	591	3837	STD	16	TL	155 A8	168 A8	km/h - bar	3.80	
												10 FR	7840	
												25 FR	6665	
												30 FR	6270	
												40 FR	5600	
												10 DW	5425	
												25 DW	4610	
												30 DW	4340	
40 DW	3875													
16.5/85 - 24	W 13	W 14 L; W 15 L	415	1325	591	3837	STD	10	TL	146 A8	158 A8	km/h - bar	2.40	
												10 FR	5950	
												25 FR	5060	
												30 FR	4760	
												40 FR	4250	
												10 DW	4200	
												25 DW	3570	
												30 DW	3360	
40 DW	3000													
16.5/85 - 24	W 13	W 14 L; W 15 L	415	1325	591	3837	STD	12	TL	151 A8	163 A8	km/h - bar	2.80	
												10 FR	6825	
												25 FR	5800	
												30 FR	5460	
												40 FR	4875	
												10 DW	4830	
												25 DW	4105	
												30 DW	3865	
40 DW	3450													
400/80 - 24	W 13	W 12 ; W 14 L	394	1262	566	3655	IND	-	TL	156 A8	km/h - bar	3.80		
											10	5000		
											25	4240		
											30	4160		
40	4000													
400/80 - 24	W 13	W 12 ; W 14 L	394	1262	566	3655	IND	-	TL	162 A8	km/h - bar	5.00		
											10	5940		
											25	5035		
											30	4940		
40	4750													

STD: Standard - IND: Industrial

Technologies



Heavy Duty



Reinforced Carcass



Aramid Belted

Performance



Cut and Chip Resistance



Durability



Self-Cleaning



Stability



Traction



IMPLEMENT

Bias



AS 505

AS 505 is best suited for soil tillage operations with trailers and implement machinery. It features excellent self-cleaning properties and increased traction on the ground, especially on muddy soil. The tire also ensures a long tire life-cycle.

Ø 15"	Tire size	RIM		S.W. (mm)	O.D. (mm)	SLR (mm)	RC (mm)	Version	PR	Type	LI/SS Drive Wheel	LI/SS Free Rolling	Load capacity (kg/tire)		
		Rec.	Alt.										km/h - bar		
														4.80	
	6.5/80 - 15	5.0	4½ K ; 5 K ; 5 J	171	695	325	2106	STD	8	TL	92A8	104A8		1260	
														1070	
														1010	
														900	
														880	
														750	
														705	
														630	
														3.60	
	6.5/80 - 15	5.0	4½ K ; 5 K ; 5 J	171	695	325	2106	STD	6	TL	86A8	98A8		1050	
														895	
														840	
														750	
														740	
														630	
														595	
														530	

STD: Standard

Performance



Durability



Self-Cleaning



Traction





IMPLEMENT

Bias



AS 507

AS 507 is suitable for soil tillage with trailers and implement machinery. It features excellent self-cleaning properties and increased traction on the ground.

Ø 15"	Tire size	RIM		S.W. (mm)	O.D. (mm)	SLR (mm)	RC (mm)	Version	PR	Type	LI/SS Drive Wheel	LI/SS Free Rolling	Load capacity (kg/tire)	
		Rec.	Alt.										km/h - bar	2.80
	185/65 - 15	5½ J	-	185	640	301	1894	STD	4	TL	76 A8	89 A8	10 FR	810
													25 FR	690
													30 FR	650
													40 FR	580
													10 DW	560
													25 DW	475
													30 DW	450
													40 DW	400

STD: Standard

Performance



Durability



Self-Cleaning



Traction

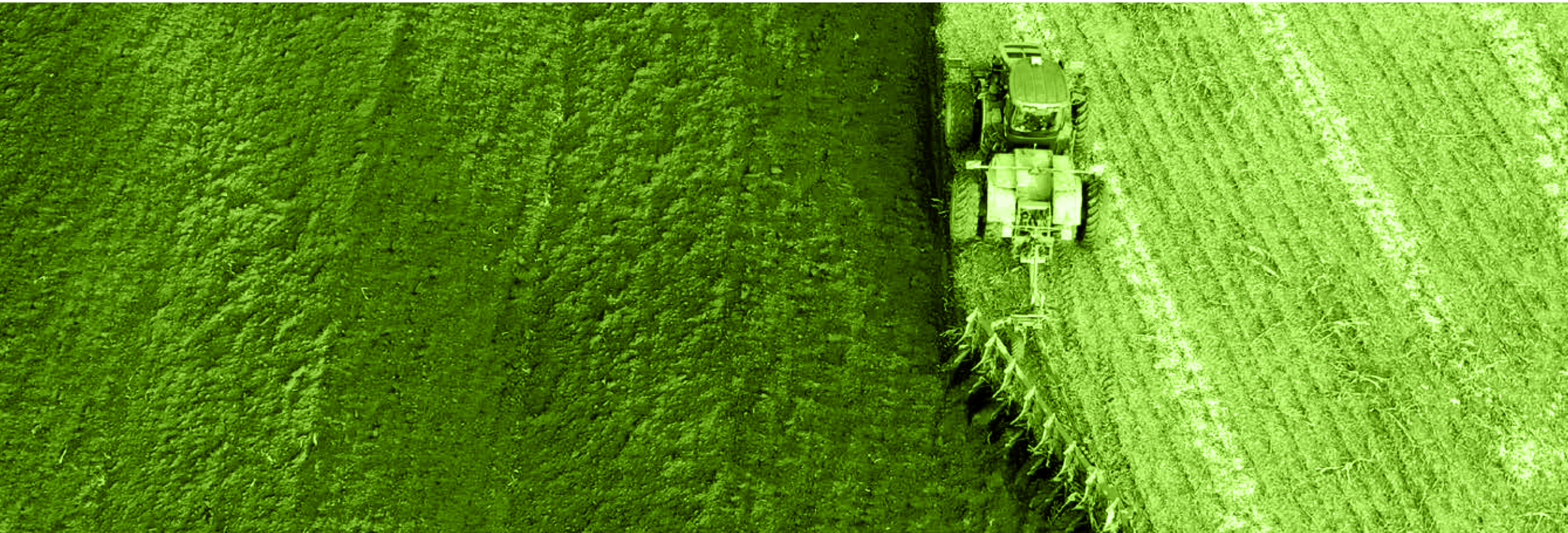



IMPLEMENT

Bias

AS 509



AS 509 has been specially designed for trailers, balers and implement machinery. It ensures high load capacity at low inflation pressure protecting crops. AS 509 provides great traction and self-cleaning properties.

Ø 22.5"	Tire size	RIM		S.W. (mm)	O.D. (mm)	SLR (mm)	RC (mm)	Version	PR	Type	LI/SS Drive Wheel	LI/SS Free Rolling	Load capacity (kg/tire)			
		Rec.	Alt.										km/h - bar			
													1.50	1.80	2.10	3.00
550/45 - 22.5	AG 16.00	-	540	1065	479	3250	STD	12	TL	141 A8/137 B	153 A8/149 B	10 FR	4200	4670	5110	
												20 FR	3780	4200	4600	
												30 FR	3360	3735	4090	
												40 FR	3000	3335	3650	
												50 FR	2700	3000	3250	
												10 DW	2960	3295	3605	
												20 DW	2665	2965	3245	
												30 DW	2370	2640	2885	
												40 DW	2115	2355	2575	
												50 DW	1905	2120	2300	
550/45 - 22.5	AG 16.00	-	540	1065	479	3250	STD	20	TL	154 A8/150 B	166 A8/162 B	10 FR	6270	6860	7420	
												20 FR	5645	6175	6680	
												30 FR	5020	5490	5915	
												40 FR	4480	4900	5300	
												50 FR	4030	4410	4750	
												10 DW	4440	4860	5250	
												20 DW	3995	4370	4725	
												30 DW	3550	3885	4200	
												40 DW	3170	3470	3750	
												50 DW	2855	3125	3350	

STD: Standard

Performance



Durability



High Load Capacity



Self-Cleaning



Traction





IMPLEMENT

Bias



FARM 2000 (R-1)

The FARM 2000 tire is suitable on tractors for soil tillage applications. It has been designed with a special cut-and-chip resistant compound to ensure better durability. Thanks to its strong casing, FARM 2000 offers high load capacity. It also provides great traction and self-cleaning properties.

Ø 15.3"	Tire size	RIM		S.W. (mm)	O.D. (mm)	SLR (mm)	RC (mm)	Version	PR	Type	LI/SS Drive Wheel	LI/SS Free Rolling	Load capacity (kg/tire)	
		Rec.	Alt.										km/h - bar	3.60
260/70 - 15.3	9.00	-	265	775	349	2294	STD	-	TL	114A8	126A8	10 FR	2380	
												25 FR	2025	
												30 FR	1905	
												40 FR	1700	
												10 DW	1650	
												25 DW	1405	
												30 DW	1320	
40 DW	1180													
300/80 - 15.3	9.00	-	300	890	388	2608	STD	-	TL	120A8	132A8	10 FR	2800	
												25 FR	2380	
												30 FR	2240	
												40 FR	2000	
												10 DW	1960	
												25 DW	1665	
												30 DW	1570	
40 DW	1400													
Ø 16"	250/80 - 16	W 8	W 7 ; W 9 ; W 8 L	240	820	369	2429	STD	-	TT	113A8	125A8	10 FR	2310
													25 FR	1965
													30 FR	1850
													40 FR	1650
													10 DW	1610
													25 DW	1370
													30 DW	1290
40 DW	1150													
250/80 - 16	W 8	W 7 ; W 9 ; W 8 L	240	820	369	2429	STD	-	TL	113A8	125A8	10 FR	2310	
												25 FR	1965	
												30 FR	1850	
												40 FR	1650	
												10 DW	1610	
												25 DW	1370	
												30 DW	1290	
40 DW	1150													

STD: Standard

Technologies

- Reinforced Carcass
- Special Compound
- Strong Casing

Performance

- Cut and Chip Resistance
- Durability
- High Load Capacity
- Self-Cleaning
- Traction





FARM 2000 (R-1)

Ø 18"	Tire size	RIM		S.W. (mm)	O.D. (mm)	SLR (mm)	RC (mm)	Version	PR	Type	LI/SS Drive Wheel	LI/SS Free Rolling	Load capacity (kg/tire)	
		Rec.	Alt.										km/h - bar	
250/80 - 18	W 8	W7 ; W9	240	870	394	2679	STD	-	TT	115 A8	127 A8	km/h - bar	2.80	
												10 FR	2450	
												25 FR	2085	
												30 FR	1960	
												40 FR	1750	
												10 DW	1700	
												25 DW	1445	
												30 DW	1360	
												40 DW	1215	
												250/80 - 18	W 8	W7 ; W9
10 FR	2450													
25 FR	2085													
30 FR	1960													
40 FR	1750													
10 DW	1700													
25 DW	1445													
30 DW	1360													
40 DW	1215													
8 - 18	W 6	-	195	840	390	2458	STD	4	TT	-	85 A6			
												30	515	
8 - 18	W 6	-	195	840	393	2539	STD	6	TT	-	94 A6	km/h - bar	1.90	
												30	670	
Ø 20"	8.3 - 20	W 7	-	210	895	431	2714	STD	4	TT	-	-	km/h - bar	1.60
													30	560
	8.3 - 20	W 7	-	210	895	431	2714	STD	6	TT	-	-	km/h - bar	2.40
													30	710
Ø 24"	8.3 - 24	W 7	W 6	211	995	473	3032	STD	6	TT	-	-	km/h - bar	2.40
													30	810
	8.3 - 20	W 7	W 6	211	995	473	3032	STD	8	TT	-	105 A6	km/h - bar	3.10
													30	925

STD: Standard

Technologies



Reinforced Carcass



Special Compound



Strong Casing

Performance



Cut and Chip Resistance



Durability



High Load Capacity



Self-Cleaning



Traction





FARM 2000 (R-1)

Ø 28"	Tire size	RIM		S.W. (mm)	O.D. (mm)	SLR (mm)	RC (mm)	Version	PR	Type	LI/SS Drive Wheel	LI/SS Free Rolling	Load capacity (kg/tire)	
		Rec.	Alt.										km/h - bar	
12.4 - 28	W 11	W 9; W 10	320	1288	603	3969	STD	8	TT	-	123 A6	30	2.30	1550
12.4 - 28	W 11	W 9; W 10	320	1288	603	3969	STD	10	TT	-	124 A6	30	2.40	1600
12.4 - 28	W 11	W 9; W 10	320	1288	603	3969	STD	12	TT	-	125 A6	30	2.50	1650
13.6 - 28	W 12	W 11	345	1335	622	4080	STD	8	TT	-	125 A6	30	2.00	1650
13.6 - 28	W 12	W 11	345	1335	622	4080	STD	10	TT	-	127 A6	30	2.2	1750
13.6 - 28	W 12	W 11	345	1335	622	4080	STD	12	TT	-	128 A6	30	2.30	1800
13.6 - 28	W 12	W 11	345	1335	622	4080	SPL	12	TT	-	128 A6	30	2.30	1800
14.9 - 28	W 13	W 11; W 12	385	1375	636	4194	STD	8	TT	-	130 A6	30	1.80	1900
14.9 - 28	W 13	W 11; W 12	385	1375	636	4194	STD	10	TT	-	132 A6	30	2.10	2120
14.9 - 28	W 13	W 11; W 12	385	1375	636	4194	STD	12	TT	-	134 A6	30	2.30	2120
14.9 - 28	W 13	W 11; W 12	385	1375	636	4194	STD	14	TT	-	136 A6	30	2.50	2240

STD: Standard - SPL: Special

Technologies



Reinforced Carcass



Special Compound



Strong Casing

Performance



Cut and Chip Resistance



Durability



High Load Capacity



Self-Cleaning



Traction





IMPLEMENT

FARM 2000 (R-1)

Ø 28"	Tire size	RIM		S.W. (mm)	O.D. (mm)	SLR (mm)	RC (mm)	Version	PR	Type	LI/SS Drive Wheel	LI/SS Free Rolling	Load capacity (kg/tire)	
		Rec.	Alt.										km/h - bar	
16.9 - 28	W 15 L	W 14 L	429	1420	657	4351	STD	12	TT	-	143 A6	30	2725	
												km/h - bar	2.40	
16.9 - 28	W 15 L	W 14 L	429	1420	657	4351	HD	8	TT	-	135 A6	30	2180	
												km/h - bar	1.70	
Ø 30"	18.4 - 30	W 16 L	-	470	1560	716	4776	STD	14	TT	-	151 A6	30	3450
													km/h - bar	2.6

STD: Standard - HD: Heavy Duty

Technologies



Reinforced Carcass



Special Compound



Strong Casing

Performance



Cut and Chip Resistance



Durability



High Load Capacity



Self-Cleaning



Traction





IMPLEMENT

Bias



TR 393

TR 393 has been specially designed for hay balers, spreaders and implement machinery on and off the road. The special tread design provides best flotation and self-cleaning properties in addition to a long service life. Thanks to its large contact area, TR 393 (A) ensures excellent traction and minimizes soil compaction.

Ø 16.1"	Tire size	RIM		S.W. (mm)	O.D. (mm)	SLR (mm)	RC (mm)	Version	PR	Type	LI/SS	Load capacity (kg/tire)	
		Rec.	Alt.									km/h - bar	
16.5L - 16.1 SL	W14C W14CH	420	1025	461	2966	STD	6	TL	128 B	50	1.70	1800	
										50	1.90	3000	
21.5L - 16.1 SL	W 18 CH W 16 CH	546	1154	-	-	STD	10	TL	146 B	50	1.90	3000	
										50	1.70	1800	

STD: Standard

Performance



Excellent flotation



Reduced Soil Compaction



Self-Cleaning



Traction





IMPLEMENT

Bias



TR 393 (B)

TR 393 (B) has been specially designed for seeders, spreaders and implement machinery on and off the road. The special tread design provides best flotation and self-cleaning properties in addition to a long service life. Thanks to its large contact area, TR 393 ensures excellent traction and minimizes soil compaction.

Ø 15"	Tire size	RIM		S.W. (mm)	O.D. (mm)	SLR (mm)	RC (mm)	Version	PR	Type	LI/SS	Load capacity (kg/tire)	
		Rec.	Alt.									km/h - bar	
	31 X 13.50 - 15	10 LB	-	350	777	-	-	SR	12	TL	124 B	50	1600

SR: Stubble Resistant

Performance



Excellent flotation



Reduced Soil Compaction



Self-Cleaning



Traction



IMPLEMENT

Bias



TR 882

TR 882 is a very versatile tire suitable for several applications and vehicles. It has been designed to fit implement machinery, hay harvesters/balers and sugar cane machinery. Engineered with a special compound to reduce damage, this tire features also great durability and traction in every field condition. TR 882 is also available as "aramid-belted", "HD" and "special" versions to meet specific end user requirements.

Ø 15.5"	Tire size	RIM		S.W. (mm)	O.D. (mm)	SLR (mm)	RC (mm)	Version	PR	Type	LI/SS Drive Wheel	LI/SS Free Rolling	Load capacity (kg/tire)	
		Rec.	Alt.										km/h - bar	
400/60 - 15.5	AG 13.00	-	400	875	378	2605	STD	8	TL	122 A8	134 A8	10 FR	2970	
												25 FR	2525	
												30 FR	2375	
												40 FR	2120	
												10 DW	2100	
												25 DW	1785	
												30 DW	1680	
40 DW	1500													
400/60 - 15.5	AG 13.00	-	400	875	378	2605	STD	14	TL	132 A8	145 A8	10 FR	4060	
												25 FR	3450	
												30 FR	3250	
												40 FR	2900	
												10 DW	2800	
												25 DW	2380	
												30 DW	2240	
40 DW	2000													
400/60 - 15.5	AG 13.00	-	400	875	378	2605	STD	18	TL	137 A8	149 A8	10 FR	4550	
												25 FR	3870	
												30 FR	3640	
												40 FR	3250	
												10 DW	3220	
												25 DW	2735	
												30 DW	2575	
40 DW	2300													
400/60 - 15.5	AG 13.00	-	400	875	378	2605	AB	14	TL	132 A8	145 A8	10 FR	4060	
												25 FR	3450	
												30 FR	3250	
												40 FR	2900	
												10 DW	2800	
												25 DW	2380	
												30 DW	2240	
40 DW	2000													

STD: Standard - AB: Aramid Belted

Technologies



Performance





Ø 15.5"	Tire size	RIM		S.W. (mm)	O.D. (mm)	SLR (mm)	RC (mm)	Version	PR	Type	LI/SS Drive Wheel	LI/SS Free Rolling	Load capacity (kg/tire)	
		Rec.	Alt.										km/h - bar	
400/60 - 15.5	AG 13.00	-	400	875	378	2605	AB HD	18	TL	137 A8	149 A8		km/h - bar	4.50
													10 FR	4550
													25 FR	3870
													30 FR	3640
													40 FR	3250
													10 DW	3220
													25 DW	2735
													30 DW	2575
40 DW	2300													
400/60 - 15.5	AG 13.00	-	400	875	378	2605	HD	14	TL	132 A8	145 A8		km/h - bar	3.60
													10 FR	4060
													25 FR	3450
													30 FR	3250
													40 FR	2900
													10 DW	2800
													25 DW	2380
													30 DW	2240
40 DW	2000													
400/60 - 15.5	AG 13.00	-	400	875	378	2605	HD	18	TL	137 A8	149 A8		km/h - bar	4.50
													10 FR	4550
													25 FR	3870
													30 FR	3640
													40 FR	3250
													10 DW	3220
													25 DW	2735
													30 DW	2575
40 DW	2300													
400/60 - 15.5	AG 13.00	-	400	875	378	2605	SPL	14	TL	132 A8	145 A8		km/h - bar	3.60
													10 FR	4060
													25 FR	3450
													30 FR	3250
													40 FR	2900
													10 DW	2800
													25 DW	2380
													30 DW	2240
40 DW	2000													
400/60 - 15.5	AG 13.00	-	400	875	378	2605	SPL	18	TL	137 A8	149 A8		km/h - bar	4.50
													10 FR	4550
													25 FR	3870
													30 FR	3640
													40 FR	3250
													10 DW	3220
													25 DW	2735
													30 DW	2575
40 DW	2300													

AB HD: Aramid Belted HD - HD: Heavy Duty - SPL: Special

Technologies



Heavy Duty



Special Compound



Aramid Belted

Performance



Cut and Chip Resistance



Durability



Stubble Resistance



Traction



IMPLEMENT

Bias



SL 441

SL 441 is a tire developed for soil tillage and haulage operations with trailers and implement machinery. SL 441 has been engineered to offer great load capacity and a long tire life-cycle.

Ø 14.5"	Tire size	RIM		S.W. (mm)	O.D. (mm)	SLR (mm)	RC (mm)	Version	PR	Type	LI/SS Free Rolling	Load capacity (kg/tire)	
		Rec.	Alt.									km/h - bar	
200/60 - 14.5	AG 6.75	-	210	610	278	1785	STD	10	TT	106 A8		5.00	
												10 FR	1330
												25 FR	1130
												30 FR	1065
												40 FR	950
200/60 - 14.5	AG 6.75	-	210	610	278	1785	STD	14	TL	113 A8		7.00	
												10 FR	1610
												25 FR	1370
												30 FR	1290
												40 FR	1150
200/60 - 14.5	AG 6.75	-	210	610	278	1785	STD	14	TT	113 A8		7.00	
												10 FR	1610
												25 FR	1370
												30 FR	1290
												40 FR	1150

STD: Standard

Performance



Durability



High Load Capacity





IMPLEMENT

Bias



PL 846

PL 846 has been specially designed for implement machinery in soil tillage applications. It features excellent stability and outstanding traction as well as high cut and chip resistance. PL 846 is the ideal tire on rocky surfaces.

Ø 9"	Tire size	RIM		S.W. (mm)	O.D. (mm)	SLR (mm)	RC (mm)	Version	PR	Type	LI/SS	Load capacity (kg/tire)		
		Rec.	Alt.									km/h - bar		
	6.00 - 9	4.00 E	-	160	540	-	-	STD	10	TT	-	25	8.50	1320
	6.00 - 9	4.00 E	-	160	540	-	-	STD	12	TT	-	25	10.00	1450

STD: Standard

Performance





IMPLEMENT

Radial



SR 713 (I-1)

SR 713 is an All Steel radial tire with VF technology for farming implements. The tire features a strong multi-ply steel-belted casing and a multi-rib tread pattern ensuring low rolling resistance and a uniform tread wear. Thanks to its large footprint, this VF tire provides reduced soil compaction. SR 713 excels in both performance and reliability offering excellent speed levels even on the road.

Ø 19.5"	Tire size	LI/SS	RIM		O.W. (mm)	O.D. (mm)	SLR (mm)	RC (mm)	SRI (index)	Version	Load capacity (kg/tire)												
			Rec.	Alt.							km/h - bar												
VF 245/70 R 19.5	142 D	7.50	-	245	844	373	2559	-	STD	65	2650												
										65	3000												
VF 265/70 R 19.5	146 D	7.50	8.25	255	873	391	2612	-	STD	65	3250												
										65	3875												
VF 255/70 R 22.5	149 D	8.25	7.50	255	933	406	2790	-	STD	65	3450												
										65	4435												
VF 295/75 R 22.5	155 D	9.00	8.25	280	1020	449	3044	-	STD	65	4875												
										65	5900												
VF 295/75 R 22.5	151 D	9.00	8.25	280	1020	449	3044	-	STD	65	5215												
										65	6630												
VF 385/65 R 22.5	163 D	11.75	12.25	385	1080	487	3251	-	STD	km/h - bar	2.4	2.6	2.8	3	3.2	3.4	3.6	3.8	4	4.2	4.4	4.6	4.8
										0	6440	6900	7245	7705	7935	8395	8915	9200	9775	10065	10640	10925	11215
										10	5040	5400	5670	6030	6210	6570	6975	7200	7650	7875	8325	8550	8775
										15	4845	5190	5450	5795	5970	6315	6705	6920	7355	7570	8000	8220	8435
										25	4425	4740	4975	5295	5450	5765	6125	6320	6715	6915	7310	7505	7705
										30	4230	4530	4755	5060	5210	5510	5850	6040	6420	6605	6985	7175	7360
										40	3810	4080	4285	4555	4690	4965	5270	5440	5780	5950	6290	6460	6630
										50	3390	3630	3810	4055	4175	4415	4690	4840	5145	5295	5595	5750	5900
										60	2995	3210	3370	3585	3690	3905	4145	4280	4550	4680	4950	5085	5215
										65	2800	3000	3150	3350	3450	3650	3875	4000	4250	4375	4625	4750	4875
										70	2550	2730	2865	3050	3140	3320	3525	3640	3870	3980	4210	4325	4435
VF 445/65 R 22.5	169 D	13.00	14.00	440	1160	533	3515	-	STD	65	5800												
										65	7100												
VF 445/65 R 22.5	176 D	13.00	14.00	440	1160	533	3515	-	STD	65	7100												
										65	8435												

Technologies



Performance



STD: Standard

LAWN & GARDEN





TR 360

TR 360 is suitable for implement machinery in on-and-off-the-road transport as well as lawn and garden applications. The particular tread design along with the casing structure ensures a long tire life-cycle.

Ø 8"	Tire size	RIM		S.W. (mm)	O.D. (mm)	SLR (mm)	RC (mm)	Version	PR	Type	LI/SS	Load capacity (kg/tire)	
		Rec.	Alt.									km/h - bar	
	18 X 7 - 8	5.5	-	180	460	202	1334	STD	6	TL	-	15	450

Performance



Durability

STD: Standard



LG SMOOTH

LG SMOOTH is a lawn and garden tire suitable for mowers. While the tire is gentle on the ground, the enhanced design ensures increased durability and eases handling. LG SMOOTH is available in an "aramid-belted" version for users who need strengthened puncture resistance.

Ø 8"	Tire size	RIM		S.W. (mm)	O.D. (mm)	SLR (mm)	RC (mm)	Version	PR	Type	LI/SS	Load capacity (kg/tire)	
		Rec.	Alt.									km/h - bar	
	16 X 6.50 - 8	5.375 I-55; I-70; I-90	-	160	400	-	-	AB	10	TL	-	15	470
Ø 10"	18 X 10.50 - 10	8.5 I-55; I-70; I-90	8½ JA	254	460	207	1334	STD	2	TL	-	15	334
	20 X 10.00 - 10	8.00 I-55	7.00 I-55; I-70; I-90	245	500	223	1450	AB	6	TL	-	15	660
	20 X 10.00 - 10	8.00 I-55	7.00 I-55; I-70; I-90	245	500	223	1450	STD	2	TL	-	15	335
	20 X 10.00 - 10	8.00 I-55	7.00 I-55; I-70; I-90	245	500	223	1450	STD	4	TL	-	15	530
	20 X 10.00 - 10	8.00 I-55	7.00 I-55; I-70; I-90	245	500	223	1450	STD	6	TL	-	15	660

Technologies



Aramid Belted

Performance



Field Protection



High Puncture Resistance

STD: Standard - AB: Aramid Belted



LG 306

LG 306 is a lawn and garden tire suitable for mowers. In some sizes, LG 306 is also fit for small tractors. The specific tread pattern makes the tire gentle on the ground, easing handling at the same time. LG 306 is available in an "aramid-belted" version for users who need strengthened puncture resistance.

Ø 5"	Tire size	RIM		S.W. (mm)	O.D. (mm)	SLR (mm)	RC (mm)	Version	PR	Type	LI/SS	Load capacity (kg/tire)		
		Rec.	Alt.									km/h - bar		
Ø 5"	11 X 4.00 - 5	3.00 A	-	104	272	120	789	STD	4	TL	-	15	3.20	
													150	
Ø 6"	13 X 5.00 - 6	3.50 A	-	127	325	144	943	STD	6	TL	-	15	4.20	
													255	
	13 X 5.00 - 6	3.50 A	-	127	325	144	943	STD	4	TL	-	15	2.80	
													200	
	15 X 6.00 - 6	4.50 A	-	152	365	159	1059	STD	4	TL	-	15	2.10	
													257	
	15 X 6.00 - 6	4.50 A	-	152	365	159	1059	STD	6	TL	-	15	3.20	
													335	
	Ø 8"	16 X 6.50 - 8	5.375 I-55; I-70; I-90	-	170	408	182	1183	AB	6	TL	-	15	2.90
														355
16 X 6.50 - 8		5.375 I-55; I-70; I-90	-	170	408	182	1183	STD	6	TL	-	15	2.90	
													355	
16 X 6.50 - 8		5.375 I-55; I-70; I-90	-	170	408	182	1183	STD	8	TL	-	15	3.70	
													400	
16 X 6.50 - 8		5.375 I-55; I-70; I-90	-	170	408	182	1183	STD	4	TL	-	15	1.90	
													280	
16 X 7.50 - 8		5.375 I-55; I-70; I-90	-	178	400	-	-	AB	4	TL	-	15	1.80	
													345	

Technologies



Aramid Belted

Performance



Comfort



Field Protection



High Puncture Resistance

STD: Standard - AB: Aramid Belted



Ø 8"	Tire size	RIM		S.W. (mm)	O.D. (mm)	SLR (mm)	RC (mm)	Version	PR	Type	LI/SS	Load capacity (kg/tire)		
		Rec.	Alt.									km/h - bar		
18 X 8.50 - 8	7.00 1-55; 1-70; 1-90	-	215	450	204	1346	AB	6	TL	-		km/h - bar	2.30	
												15	475	
18 X 8.50 - 8	7.00 1-55; 1-70; 1-90	-	215	450	204	1346	STD	4	TL	-		km/h - bar	1.50	
												15	375	
18 X 8.50 - 8	7.00 1-55; 1-70; 1-90	-	215	450	204	1346	STD	6	TL	-		km/h - bar	2.30	
												15	475	
18 X 9.50 - 8	7.00 1-55; 1-70; 1-90	-	230	470	206	1363	AB	6	TL	-		km/h - bar	2.50	
												15	605	
18 X 9.50 - 8	7.00 1-55; 1-70; 1-90	-	230	470	206	1363	STD	6	TL	-		km/h - bar	2.50	
												15	605	
18 X 9.50 - 8	7.00 1-55; 1-70; 1-90	-	230	470	206	1363	STD	4	TL	-		km/h - bar	1.40	
												15	425	
20 X 10.00 - 8	8.00 1-55	7.00 1-55; 1-70; 1-90	254	508	221	1473	AB	6	TL	-		km/h - bar	2.20	
												15	670	
20 X 10.00 - 8	8.00 1-55	7.00 1-55; 1-70; 1-90	254	508	221	1473	STD	4	TL	-		km/h - bar	1.50	
												15	545	
20 X 10.00 - 8	8.00 1-55	7.00 1-55; 1-70; 1-90	254	508	221	1473	STD	6	TL	-		km/h - bar	2.20	
												15	670	
Ø 10"	18 X 8.50 - 10	7.00 1-55; 1-70; 1-90	-	210	460	209	1340	STD	4	TL	-		km/h - bar	1.50
													15	361
20 X 10.00 - 10	8.00 1-55	7.00 1-55	250	508	226	1473	AB	6	TL	-		km/h - bar	2.20	
												15	660	
20 X 10.00 - 10	8.00 1-55	7.00 1-55	250	508	226	1473	STD	6	TL	-		km/h - bar	2.20	
												15	660	
20 X 10.00 - 10	8.00 1-55	7.00 1-55	250	508	226	1473	STD	4	TL	-		km/h - bar	1.50	
												15	530	

Technologies



Aramid Belted

Performance



Comfort



Field Protection



High Puncture Resistance

STD: Standard - AB: Aramid Belted



Ø 10"	Tire size	RIM		S.W. (mm)	O.D. (mm)	SLR (mm)	RC (mm)	Version	PR	Type	LI/SS	Load capacity (kg/tire)		
		Rec.	Alt.									km/h - bar		
20 X 8.00 - 10	6.00 1-55; 1-70; 1-90	6 JA	205	500	223	1450	STD	4	TL	-		15	1.70	
													412	
20 X 8.00 - 10	6.00 1-55; 1-70; 1-90	6 JA	205	500	223	1450	STD	6	TL	-		15	2.50	
													510	
Ø 12"	23 X 10.50 - 12	8.51-55	7.00 1-55; 1-70; 1-90	260	585	262	1697	AB	6	TL	-		15	2.20
														800
23 X 10.50 - 12	8.51-55	7.00 1-55; 1-70; 1-90	260	585	262	1697	STD	6	TL	-		15	2.20	
													800	
23 X 10.50 - 12	8.51-55	7.00 1-55; 1-70; 1-90	260	585	262	1697	STD	4	TL	-		15	1.40	
													600	
23 X 10.50 - 12	8.51-55	7.00 1-55; 1-70; 1-90	260	585	262	1697	STD	8	TL	-		15	3.00	
													955	
23 X 10.50 - 12	8.51-55	7.00 1-55; 1-70; 1-90	260	585	262	1697	STD	12	TL	-		15	4.50	
													1215	
23 X 8.50 - 12	7.00 1-55; 1-70; 1-90	7 JA	210	575	258	1709	AB	6	TL	-		15	2.30	
													650	
23 X 8.50 - 12	7.00 1-55; 1-70; 1-90	7 JA	210	575	261	1717	STD	12	TL	-		15	4.50	
													960	
23 X 8.50 - 12	7.00 1-55; 1-70; 1-90	7 JA	210	575	258	1709	STD	4	TL	-		15	1.50	
													500	
23 X 8.50 - 12	7.00 1-55; 1-70; 1-90	7 JA	210	575	258	1709	STD	6	TL	-		15	2.30	
													650	
23 X 8.50 - 12	7.00 1-55; 1-70; 1-90	7 JA	210	575	258	1709	STD	8	TL	-		15	3.00	
													765	

Technologies



Aramid Belted

Performance



Comfort



Field Protection



High Puncture Resistance

STD: Standard - AB: Aramid Belted



Ø 12"	Tire size	RIM		S.W. (mm)	O.D. (mm)	SLR (mm)	RC (mm)	Version	PR	Type	LI/SS Drive Wheel	LI/SS Free Rolling	Load capacity (kg/tire)	
		Rec.	Alt.										km/h - bar	
	24 X 12.00 - 12	9.5 AT	9.0 AT; 8.5 AT; 8.0 AT	298	610	276	1774	STD	4	TL		-	15	1.40 775
	26 X 12.00 - 12	10.50 1-55; 1-70; 1-90	10½ JA; 8½ JA	310	640	283	1856	AB	6	TL		-	15	2.10 1030
	26 X 12.00 - 12	10.50 1-55; 1-70; 1-90	10½ JA; 8½ JA	310	640	283	1856	AB	8	TL		-	15	3.00 1250
	26 X 12.00 - 12	10.50 1-55; 1-70; 1-90	10½ JA; 8½ JA	310	640	283	1856	STD	8	TL		-	15	3.00 1250
	26 X 12.00 - 12	10.50 1-55; 1-70; 1-90	10½ JA; 8½ JA	310	640	283	1856	STD	4	TL		-	15	1.40 800
	26 X 12.00 - 12	10.50 1-55; 1-70; 1-90	10½ JA; 8½ JA	310	640	283	1856	STD	12	TL		-	15	4.50 1600
	26 X 12.00 - 12	10.50 1-55; 1-70; 1-90	10½ JA; 8½ JA	310	640	294	1945	STD	14	TL		-	15	5.20 1740
	260/55 - 12 (23 X 10.50 - 12)	8.5 1-55	7.00 1-55; 1.70; 1-90	260	585	262	1697	IMP	14	TL	110 A8	122 A8	40 FR	6.00 1500 1060
	24 X 8.50 - 14	7 JA	-	210	610	280	1769	STD	4	TL		-	15	1.60 550
	25 X 8.50 - 14	7.00 1-55; 1-70; 1-90	-	220	638	294	1915	STD	6	TL		-	15	2.20 750
	25 X 8.50 - 14	7.00 1-55; 1-70; 1-90	-	220	638	294	1915	STD	8	TL		-	15	3.00 900
	27 X 10.50 - 15	8.00 LB	-	272	705	318	2042	STD	4	TL		-	50	2.10 600
	27 X 10.50 - 15	8.00 LB	-	272	705	318	2042	STD	12	TL		-	50	6.10 1100

Technologies



Aramid Belted

Performance



Comfort



Field Protection



High Puncture Resistance

STD: Standard - AB: Aramid Belted - IMP: Implement



Ø 15"	Tire size	RIM		S.W. (mm)	O.D. (mm)	SLR (mm)	RC (mm)	Version	PR	Type	LI/SS	Load capacity (kg/tire)	
		Rec.	Alt.									km/h - bar	
	27 X 8.50 - 15	7.00 JA	-	216	680	329	2076	STD	4	TL	-	50	2.10 560
	29 X 12.50 - 15	10	-	318	740	349	2230	AB	10	TL	-	50	4.1 1150
	31 X 15.5 - 15	13 LB	-	391	792	350	2313	STD	4	TL	-	50	1.40 775
	31 X 15.5 - 15	13 LB	-	391	792	350	2313	STD	8	TL	-	50	3.10 1250
	31 X 15.5 - 15	13 LB	-	391	792	350	2313	AB	8	TL	-	50	3.10 1250
	Ø 16"	W 12	W 11	388	975	442	2860	STD	4	TL	-	15	1.00 950
	Ø 16.5"	12.00	-	396	840	385	2538	STD	10	TL	-	15	2.10 1630
	Ø 20"	W 11	W 11 H	375	980	447	2912	STD	4	TL	-	50	1.70 1060
	44 X 18.00 - 20	W 14 L	W 14 LH	490	1165	518	3509	STD	4	TL	-	50	1.40 1550

STD: Standard - AB: Aramid Belted

Technologies



Aramid Belted

Performance



Comfort



Field Protection













High Puncture Resistance



LG 307

LG 307 is a lawn and garden tire suitable for mowers. The specific tread pattern makes the tire gentle on the ground to prevent turf damages, easing handling at the same time.

Ø 8"	Tire size	RIM		S.W. (mm)	O.D. (mm)	SLR (mm)	RC (mm)	Version	PR	Type	LI/SS	Load capacity (kg/tire)		
		Rec.	Alt.									km/h - bar		
20 X 10.00 - 8	8.00 1-55; 1-70; 1-90	7.00 1-55; 1-70; 1-90						STD	4	TL	-	15	1.50	
												15	545	
20 X 10.00 - 8	8.00 1-55; 1-70; 1-90	7.00 1-55; 1-70; 1-90						STD	6	TL	-	15	2.20	
												15	670	
Ø 10"	20 X 12.00 - 10	8.5	1-55; 1-70; 1-90	-	285	500	221	1435	STD	4	TL	-	15	1.40
													15	600

Performance



STD: Standard





LG 408

LG 408 is a lawn and garden tire suitable for mowers and small tractors. The specific tread pattern makes the tire gentle on the ground to prevent turf damages making handling easier at the same time. LG 408 is available in an "aramid-belted" version for users who need strengthened puncture resistance.

Ø 12"	Tire size	RIM		S.W. (mm)	O.D. (mm)	SLR (mm)	RC (mm)	Version	PR	Type	LI/SS	Load capacity (kg/tire)	
		Rec.	Alt.									km/h - bar	
24 X 13.00 - 12	10.5 I - 55 ; I - 70 ; I - 90	-	325	610	269	1755	STD	4	TL	-		15	1.40
													835
24 X 13.00 - 12	10.5 I - 55 ; I - 70 ; I - 90	-	325	610	269	1755	STD	6	TL	-		15	2.20
													1085
24 X 13.00 - 12	10.5 I - 55 ; I - 70 ; I - 90	-	320	605	269	1755	AB	6	TL	-		15	2.20
													1085
26.5 X 14.00 - 12	12.00 I	-	380	665	293	1929	STD	4	TL	-		15	1.30
													985
26.5 X 14.00 - 12	12.00 I	-	380	665	293	1929	STD	6	TL	-		15	2.00
													1280
26.5 X 14.00 - 12	12.00 I	-	380	665	293	1929	STD	10	TL	-		15	3.40
													1750
26.5 X 14.00 - 12	12.00 I	-	380	665	293	1929	AB	6	TL	-		15	2.00
													1280

STD: Standard - AB: Aramid Belted

Technologies



Aramid Belted

Performance



Comfort



Field Protection



High Puncture Resistance



LG RIB

LG RIB is a lawn and garden tire suitable for mowers and small tractors. Its tread pattern has been designed for making the tire gentle on the ground to prevent turf damages making handling easier at the same time. LG RIB is available in an "aramid-belted" version for users who need strengthened puncture resistance.

Ø 5"	Tire size	RIM		S.W. (mm)	O.D. (mm)	SLR (mm)	RC (mm)	Version	PR	Type	LI/SS	Load capacity (kg/tire)		
		Rec.	Alt.									km/h - bar		
Ø 5"	11 X 4.00 - 5	3.00 A	-	104	272	-	-	STD	4	TL	-	15	3.20	
													150	
Ø 6"	13 X 5.00 - 6	3.50 A	-	127	325	144	943	STD	4	TL	-	15	2.80	
													200	
	13 X 5.00 - 6	3.50 A	-	127	325	144	943	AB	6	TL	-	15	4.20	
													255	
	15 X 6.00 - 6	4.50 A	-	152	365	159	1059	STD	4	TL	-	15	2.10	
													257	
	15 X 6.00 - 6	4.50 A	-	152	365	159	1059	STD	6	TL	-	15	3.20	
													335	
	15 X 6.00 - 6	4.50 A	-	152	365	159	1059	AB	6	TL	-	15	3.20	
													335	
	Ø 8"	16 X 6.50 - 8	5.375 1-55; 1-70; 1-90	-	170	408	182	1183	STD	8	TL	-	15	3.70
														400
16 X 6.50 - 8		5.375 1-55; 1-70; 1-90	-	170	408	182	1183	STD	10	TL	-	15	4.90	
													480	
16 X 6.50 - 8		5.375 1-55; 1-70; 1-90	-	170	408	182	1183	STD	4	TT	-	15	1.90	
													280	
16 X 6.50 - 8		5.375 1-55; 1-70; 1-90	-	170	408	182	1183	STD	4	TL	-	15	1.90	
													280	

STD: Standard - AB: Aramid Belted

Technologies



Performance



Ø 8"	Tire size	RIM		S.W. (mm)	O.D. (mm)	SLR (mm)	RC (mm)	Version	PR	Type	LI/SS	Load capacity (kg/tire)	
		Rec.	Alt.									km/h - bar	
Ø 8"	16 X 6.50 - 8	5.375 1-55; 1-70; 1-90	-	170	408	182	1183	STD	6	TL	-	2.90	355
	16 X 6.50 - 8	5.375 1-55; 1-70; 1-90	-	170	408	182	1183	AB	6	TL	-	2.90	355
	16 X 6.50 - 8	5.375 1-55; 1-70; 1-90	-	170	408	182	1183	AB	10	TL	-	4.90	480
Ø 10"	20 X 10.00 - 10	8.00 1-55; 1-70; 1-90	7.00 1-55; 1-70; 1-90	236	498	222	1444	STD	4	TL	-	1.50	530
												15	530

STD: Standard - AB: Aramid Belted

Technologies



Aramid Belted

Performance



Comfort



Field Protection



High Puncture Resistance



Steering Control

Bias



LG RIB PLUS

LG RIB PLUS is a lawn and garden tire suitable for applications with mowers, small tractors and tedders. Its tread pattern has been specially designed for making the tire gentle on the ground preventing turf damages, while at the same time making the handling easier. The round profile makes LG RIB PLUS able to slide and drag easily while turning in the field.

Ø 8"	Tire size	RIM		S.W. (mm)	O.D. (mm)	SLR (mm)	RC (mm)	Version	PR	Type	LI/SS	Load capacity (kg/tire)	
		Rec.	Alt.									km/h - bar	
Ø 8"	16 X 6.50 - 8	5.375 1-55; 1-70; 1-90	-	170	408	-	-	STD	10	TL	-	4.90	480
												15	480

STD: Standard

Performance



Handling and Comfort



AGRIMAX TURF RT 333

AGRIMAX TURF RT 333 (R-3+) is a radial tire designed for small tractors in gardening, vineyards and orchards applications. Its rounded shoulder design provides low soil compaction and makes it extremely delicate on the ground. Its unique extra-deep tread (R-3+) and the special design with directional blocks stand for excellent traction both in the field and on the road, and an extended tire life cycle. AGRIMAX TURF RT 333 (R-3+) ensures great self-cleaning properties and thanks to its low rolling resistance, allows for significant fuel saving.

AGRIMAX
RADIAL TRACTOR TIRES

Ø 12"	Tire size	LI/SS	RIM		S.W. (mm)	O.D. (mm)	SLR (mm)	RC (mm)	SRI (index)	Version	Load capacity (kg/tire)								
			Rec.	Alt.							km/h - bar	0.6	0.8	1.0	1.2	1.4	1.6	2.0	2.4
220/55 R 12	82 A8/B	W 7	-	221	550	249	1645	260	STD	km/h - bar	0.6	0.8	1.0	1.2	1.4	1.6	2.0	2.4	
										50	225	265	300	335	370	395	445	475	
										40	225	265	300	335	370	395	445	475	
										30	240	285	325	360	395	425	475	510	
										10 LT	305	355	405	450	495	535	600	640	
10 HT	240	285	325	360	395	425	475	510											
240/60 R 12	89 A8/B	W 7	-	242	592	269	1777	-	STD	km/h - bar	0.6	0.8	1.0	1.2	1.4	1.6	2.0	2.4	
										50	270	310	355	395	445	485	540	580	
										40	270	310	355	395	445	485	540	580	
										30	290	335	385	425	475	520	585	625	
										10 LT	360	415	480	535	595	650	730	780	
10 HT	290	335	385	425	475	520	585	625											
Ø 16"	200/65 R 16	94 A8/B	W 6	-	202	666	309	2000	320	STD	km/h - bar	0.6	0.8	1.0	1.2	1.4	1.6	2.0	2.4
											50	315	370	425	470	520	560	625	670
											40	315	370	425	470	520	560	625	670
											30	340	400	455	505	555	600	670	720
											10 LT	425	495	570	630	695	750	840	900
10 HT	340	400	455	505	555	600	670	720											
200/70 R 16	94 A8/B	W 6	-	200	686	317	2054	330	STD	km/h - bar	0.6	0.8	1.0	1.2	1.4	1.6	2.0	2.4	
										50	315	365	420	470	525	580	625	670	
										40	315	365	420	470	525	580	625	670	
										30	340	390	450	505	565	620	670	720	
										10 LT	425	490	560	630	705	775	840	900	
10 HT	340	390	450	505	565	620	670	720											
240/70 R 16	104 A8/B	W 8	W 8 L ; W 9	244	742	340	2213	350	STD	km/h - bar	0.6	0.8	1.0	1.2	1.4	1.6	2.0	2.4	
										50	425	490	560	630	705	775	850	900	
										40	425	490	560	630	705	775	850	900	
										30	455	525	600	680	755	830	910	965	
										10 LT	570	655	755	850	945	1045	1140	1210	
10 HT	455	525	600	680	755	830	910	965											
260/70 R 16	109 A8/ 109 B	W 8	W 8 L ; W 9	258	770	348	2287	370	STD	km/h - bar	0.6	0.8	1.0	1.2	1.4	1.6	2.0	2.4	
										50	485	560	640	725	805	890	970	1030	
										40	485	560	640	725	805	890	970	1030	
										30	520	600	690	775	865	955	1040	1105	
										10 LT	655	750	860	970	1085	1195	1305	1385	
10 HT	520	600	690	775	865	955	1040	1105											
280/70 R 16	112 A8/ 112 B	W 9	W 8 ; W 10	289	800	359	2371	390	STD	km/h - bar	0.6	0.8	1.0	1.2	1.4	1.6	2.0	2.4	
										50	530	605	695	785	875	965	1055	1120	
										40	530	605	695	785	875	965	1055	1120	
										30	565	650	745	840	940	1035	1130	1200	
										10 LT	710	815	935	1055	1175	1295	1415	1505	
10 HT	565	650	745	840	940	1035	1130	1200											
Ø 18"	280/70 R 18	114 A8/ 114 B	W 9	W 8 ; W 10	289	840	390	2550	410	STD	km/h - bar	0.6	0.8	1.0	1.2	1.4	1.6	2.0	2.4
											50	555	640	735	830	925	1015	1110	1180
											40	555	640	735	830	925	1015	1110	1180
											30	595	685	785	890	990	1090	1190	1265
											10 LT	745	860	985	1110	1240	1365	1490	1585
10 HT	595	695	785	890	990	1090	1190	1265											

Technologies

- Extra Deep Tread
- Performance
- Durability
- Low Rolling Resistance
- Reduced Soil Compaction
- Self-Cleaning
- Traction

STD: Standard

AGRIMAX TURF RT 333

Ø 18"	Tire size	LI/SS	RIM		S.W. (mm)	O.D. (mm)	SLR (mm)	RC (mm)	SRI (index)	Version	Load capacity (kg/tire)						
			Rec.	Alt.							km/h - bar	0.6	0.8	1.0	1.2	1.4	1.6
Ø 18"	320/65 R 18	109 A8/ 109 B	W10	W9 ; W11	319	873	394	2591	425	STD	50	570	660	755	845	940	1030
											40	570	660	755	845	940	1030
											30	610	710	810	910	1010	1105
											10 LT	765	890	1015	1140	1265	1385
											10 HT	610	710	810	910	1010	1105
Ø 20"	300/70 R 20	110 A8/ 110 B	W9	W10	295	952	431	2826	450	STD	50	585	680	775	870	965	1060
											40	585	680	775	870	965	1060
											30	625	730	830	935	1035	1135
											10 LT	785	915	1045	1170	1300	1425
											10 HT	625	730	830	935	1035	1135
	320/70 R 20	113 A8/ 113 B	W10	W9 ; W11	319	982	441	2916	475	STD	50	635	740	840	945	1050	1150
											40	635	740	840	945	1050	1150
											30	680	795	905	1015	1125	1235
											10 LT	850	990	1130	1270	1410	1545
											10 HT	680	795	905	1015	1125	1235
	380/70 R 20	122 A8/ 122 B	W 12	W 11 ; W 13	380	1082	486	3213	525	STD	50	825	960	1095	1230	1365	1500
											40	825	960	1095	1230	1365	1500
											30	885	1030	1175	1320	1465	1605
											10 LT	1110	1290	1470	1650	1830	2010
											10 HT	885	1030	1175	1320	1465	1605
Ø 24"	360/70 R 24	122 A8/ 122 B	W 11	W 10 ; W 12	357	1152	518	3409	550	STD	50	825	960	1095	1230	1365	1500
											40	825	960	1095	1230	1365	1500
											30	885	1030	1175	1320	1465	1605
											10 LT	1110	1290	1470	1650	1830	2010
											10 HT	885	1030	1175	1320	1465	1605
	380/70 R 24	125 A8/ 125 B	W 12	W 11 ; W 13	380	1190	534	3538	575	STD	50	910	1060	1205	1355	1505	1650
											40	910	1060	1205	1355	1505	1650
											30	975	1135	1295	1455	1615	1770
											10 LT	1220	1420	1620	1820	2020	2215
											10 HT	975	1135	1295	1455	1615	1770
	420/70 R 24	130 A8/ 130 B	W 13	W 12 ; W 14 L	418	1248	557	3728	600	STD	50	1045	1220	1390	1560	1730	1900
											40	1045	1220	1390	1560	1730	1900
											30	1120	1305	1490	1670	1855	2035
											10 LT	1405	1635	1865	2095	2325	2550
											10 HT	1120	1305	1490	1670	1855	2035

STD: Standard

Technologies



Extra Deep Tread

Performance



Durability



Low Rolling Resistance



Reduced Soil Compaction



Self-Cleaning



Traction



AGRIMAX TURF RT 333

Ø 28"	Tire size	LI/SS	RIM		S.W. (mm)	O.D. (mm)	SLR (mm)	RC (mm)	SRI (index)	Version	Load capacity (kg/tire)								
			Rec.	Alt.							km/h - bar	0.6	0.8	1.0	1.2	1.4	1.6		
Ø 28"	480/70 R 28	140 A8 / 140 B	W 15 L	W 14 L ; W 16 L	479	1421	631	4228	675	STD	50	1375	1600	1825	2050	2275	2500		
											40	1375	1600	1825	2050	2275	2500		
											30	1475	1715	1955	2195	2435	2675		
											10 LT	1845	2145	2450	2750	3050	3350		
											10 HT	1475	1715	1955	2195	2435	2675		
Ø 30"	480/70 R 30	141 A8 / 141 B	W 15 L	W 14 L ; W 16 L	479	1478	660	4396	700	STD	50	1420	1650	1880	2115	2345	2575		
											40	1420	1650	1880	2115	2345	2575		
											30	1520	1770	2015	2265	2515	2760		
											10 LT	1905	2215	2525	2835	3145	3455		
											10 HT	1520	1770	2015	2265	2515	2760		
Ø 34"	480/70 R 34	149 A8 / 149 B	W 15 L	W 14 L ; W 16 L	479	1580	723	4785	750	STD	50	1530	1755	2015	2275	2535	2795	3055	3250
											40	1530	1755	2015	2275	2535	2795	3055	3250
											30	1640	1880	2160	2440	2715	2995	3275	3480
											10 LT	2050	2355	2705	3050	3400	3750	4095	4355
											10 HT	1640	1880	2160	2440	2715	2995	3275	3480

STD: Standard

Technologies



Extra Deep Tread

Performance



Durability



Low Rolling Resistance



Reduced Soil Compaction



Self-Cleaning



Traction



TRAC MASTER

TRAC MASTER is a soil tillage and lawn and garden tire, suitable for small tractors and implement machinery. Its tread design provides excellent field protection along with great traction in the fields and optimum self-cleaning properties.

Ø 12"	Tire size	RIM		S.W. (mm)	O.D. (mm)	SLR (mm)	RC (mm)	Version	PR	Type	LI/SS	Load capacity (kg/tire)	
		Rec.	Alt.									km/h - bar	
	300/60 - 12	10.5	9.5	306	645	285	1885	STD	8	TL	-	50	1030
Ø 15"	31 X 15.50 - 15	13 LB	-	405	792	357	2365	STD	6	TL	-	km/h - bar	2.10
												50	975
	31 X 15.50 - 15	13 LB	-	405	792	357	2365	STD	8	TL	-	km/h - bar	3.10
												50	1250
	33 X 15.50 - 15	13 LB	-	404	865	378	2526	STD	6	TL	-	km/h - bar	2.10
												50	1370
33 X 15.50 - 15	13 LB	-	404	865	378	2526	STD	8	TL	-	km/h - bar	3.10	
												50	1620
380/50 - 15	13 LB	-	380	780	-	-	-	STD	8	TL	116 B	km/h - bar	3.10
												50	1250

STD: Standard

Performance



Field Protection



Self-Cleaning



Traction



TR 313

TR 313 is a lawn and garden tire suitable for municipality and soil tillage operations with implement machinery, trenchers and orchard harvesters. The large contact area provides excellent grip. The TR 313 tire has been engineered to ensure a high level of stability also in critical operating conditions along with great self-cleaning properties.

Ø 15"	Tire size	RIM		S.W. (mm)	O.D. (mm)	SLR (mm)	RC (mm)	Version	PR	Type	LI/SS	Load capacity (kg/tire)	
		Rec.	Alt.									km/h - bar	
	31 X 15.50 - 15	13 LB	-	370	780	342	2233	STD	8	TL	-	50	3.10 1250

STD: Standard

Performance



Self-Cleaning



Stability



Traction



TR 315

TR 315 is suitable for lawn and garden, soil tillage and municipalities operations. It is ideal with implement machinery, trenchers and orchard harvesters. The TR 315 tire has a large contact area which provides excellent grip, great self-cleaning properties and outstanding stability in any condition.

Ø 8"	Tire size	RIM		S.W. (mm)	O.D. (mm)	SLR (mm)	RC (mm)	Version	PR	Type	LI/SS	Load capacity (kg/tire)	
		Rec.	Alt.									km/h - bar	
16 X 6.50 - 8	5.375 I - 55; I - 70; I - 90	-	-	155	408	182	1183	STD	4	TL	-	15	1.90
												15	280
16 X 6.50 - 8	5.375 I - 55; I - 70; I - 90	-	-	155	408	182	1183	STD	6	TL	-	15	2.90
												15	355
Ø 12"	23 X 8.50 - 12	-	-	205	575	258	1668	STD	4	TL	-	15	1.50
												15	500
23 X 8.50 - 12	7 JA; 7.00 I - 55; I - 70; I - 90	-	-	205	575	258	1668	STD	6	TL	-	15	2.30
												15	650
23 X 10.50 - 12	8½ JA	7 JA	-	255	600	272	1840	STD	4	TL	-	15	1.40
												15	600
23 X 10.50 - 12	8½ JA	7 JA	-	255	600	272	1840	STD	6	TL	-	15	2.20
												15	800
23 X 10.50 - 12	8½ JA	7 JA	-	255	600	272	1840	STD	8	TL	-	15	3.00
												15	960
23 X 10.50 - 12	8½ JA	7 JA	-	255	600	272	1840	STD	10	TL	-	15	3.80
												15	1100
23 X 10.50 - 12	8½ JA	7 JA	-	255	600	272	1840	STD	12	TL	-	15	4.50
												15	1215
26 X 12.00 - 12	10½ JA	8½ JA; 9½ JA	-	308	655	289	1905	STD	4	TL	-	15	1.40
												15	800
26 X 12.00 - 12	10½ JA	8½ JA; 9½ JA	-	308	655	289	1905	STD	8	TL	-	15	3.00
												15	1250

Performance



Ø 12"	Tire size	RIM		S.W. (mm)	O.D. (mm)	SLR (mm)	RC (mm)	Version	PR	Type	LI/SS	Load capacity (kg/tire)	
		Rec.	Alt.									km/h - bar	
	26 X 12.00 - 12	10½ JA	8½ JA ; 9½ JA	308	655	289	1905	STD	10	TL	-	15	3.80 1450
	26 X 12.00 - 12	10½ JA	8½ JA ; 9½ JA	308	655	289	1905	STD	12	TL	-	15	4.50 1600
	26 X 12.00 - 12	10½ JA	8½ JA ; 9½ JA	308	655	289	1905	SPL	10	TL	-	15	3.80 1450
Ø 15"	31 X 15.50 - 15	13 LB	-	390	800	354	2320	STD	8	TL	-	50	3.10 1250
	31 X 15.50 - 15	13 LB	-	390	800	354	2320	STD	10	TL	-	50	4.10 1450
	31 X 15.50 - 15	13 LB	-	390	800	354	2320	STD	12	TL	-	50	5.10 1650

STD: Standard - SPL: Special

Performance



Self-Cleaning



Stability



Traction





AT 316

AT 316 is suitable for compact utility tractors in municipality and maintenance applications. The special tread design provides excellent traction without compromising field protection - an essential feature for this kind of application. AT 316 is also available as "aramid-belted" version to provide increased puncture resistance.

Ø 12"	Tire size	RIM		S.W. (mm)	O.D. (mm)	SLR (mm)	RC (mm)	Version	PR	Type	LI/SS	Load capacity (kg/tire)	
		Rec.	Alt.									km/h - bar	
	24 X 12.00 - 12	10.50 1-55; 1-70; 1-90	-	315	610	271	1769	STD	4	TL	-	15	1.40 775
	24 X 12.00 - 12	10.50 1-55; 1-70; 1-90	-	315	610	271	1769	AB	6	TL	-	15	2.20 1030

STD: Standard - AB: Aramid Belted

Performance



Self-Cleaning

Traction



TR 317

TR 317 is suitable for municipality and soil tillage operations with implement machinery, trenchers and orchard harvesters. The TR 317 tire has a large contact area which provides excellent grip and outstanding stability in any condition along with great self-cleaning properties.

Ø 8"	Tire size	RIM		S.W. (mm)	O.D. (mm)	SLR (mm)	RC (mm)	Version	PR	Type	LI/SS	Load capacity (kg/tire)	
		Rec.	Alt.									km/h - bar	
	18 X 8.50 - 8	7.00 1-55; 1-70; 1-90	-	215	450	198	1305	STD	4	TL	-	15	1.50 375
	18 X 8.50 - 8	7.00 1-55; 1-70; 1-90	-	215	450	198	1305	HD	6	TL	-	15	2.30 475

STD: Standard - HD: Heavy Duty

Performance



Self-Cleaning

Stability

Traction



TR 318

TR 318 is specifically designed for sprayers and implement machinery. Its dual-angled lugs provide excellent traction and outstanding driving comfort. TR 318 also features extraordinary self-cleaning properties.

Ø 12"	Tire size	RIM		S.W. (mm)	O.D. (mm)	SLR (mm)	RC (mm)	Version	PR	Type	LI/SS	Load capacity (kg/tire)	
		Rec.	Alt.									km/h - bar	
	23 X 9.00 - 12	7.0	-	220	585	-	-	STD	6	TT	93 A3	15	650
	23 X 9.00 - 12	7.0	-	220	585	-	-	STD	6	TL	93 A3	15	650
	26 X 10.00 - 12	8.5	-	265	675	-	-	STD	8	TT	107 A3	15	975

STD: Standard

Performance



TR 319

TR 319 is a tire for implement machinery, orchard harvesters and trenchers in lawn and garden, municipality and soil tillage applications. Featuring a large contact area providing best traction, TR 319 is very suitable for applications on wet surfaces, where stability and self-cleaning properties are required.

Ø 12"	Tire size	RIM		S.W. (mm)	O.D. (mm)	SLR (mm)	RC (mm)	Version	PR	Type	LI/SS	Load capacity (kg/tire)	
		Rec.	Alt.									km/h - bar	
	26 X 12.00 - 12	10.50 AT	8.0 AT ; 8.5 AT ; 9.0 AT	318	640	-	-	STD	8	TL	116 A3	15	1250
Ø 15"	29 X 12.50 - 15	10 LB	-	312	755	360	2264	STD	8	TL	106 B	50	950
	29 X 12.50 - 15	10 LB	-	312	755	360	2264	STD	6	TL	98 B	50	750

STD: Standard

Performance



GOLF





GOLF

Bias



GF 304

GF 304 is suitable for golf applications with golf carts. GF 304 ensures best comfort and turf protection. GF 304 is also available as "aramid-belted" version to provide increased puncture resistance.

Ø 8"	Tire size	RIM		S.W. (mm)	O.D. (mm)	SLR (mm)	RC (mm)	Version	PR	Type	LI/SS	Load capacity (kg/tire)	
		Rec.	Alt.									km/h - bar	
18 X 8.50 - 8	7.00 I-55 ; I-70 ; I-90	-		216	460	202	1334	STD	4	TL	-	15	1.50
												15	375
18 X 8.50 - 8	7.00 I-55 ; I-70 ; I-90	-		216	460	202	1334	STD	6	TL	-	15	2.30
												15	475
18 X 8.50 - 8	7.00 I-55 ; I-70 ; I-90	-		216	460	202	1334	AB	4	TL	-	15	1.50
												15	375

STD: Standard - AB: Aramid Belted

Performance



Field Protection



GOLF

Bias



GF 305 CLASSIC

GF 305 CLASSIC is a special tire mainly designed for golf carts. This tire is naturally gentle on the ground and protects the field from damages. GF 305 CLASSIC is a really comfortable tire which makes riding a pleasure.

Ø 10"	Tire size	RIM		S.W. (mm)	O.D. (mm)	SLR (mm)	RC (mm)	Version	PR	Type	LI/SS	Load capacity (kg/tire)	
		Rec.	Alt.									km/h - bar	
205/50 - 10	7.00 I-55 ; I-70 ; I-90	-		215	470	211	1363	STD	4	TL	-	15	2.20
												15	302
205/50 - 10	7.00 I-55 ; I-70 ; I-90	-		215	470	211	1363	STD	6	TL	-	15	3.20
												15	460

STD: Standard

Performance



Field Protection

TRAILER





POWERTRAILER SR 331

POWERTRAILER SR 331 is BKT's brand-new All Steel radial tire specifically designed for trailers and tankers in transport applications. Engineered for both field and road usage, POWERTRAILER SR 331 distinguishes itself with good flotation properties in the fields as well as excellent traction on asphalt or other hard, improved surfaces. The All Steel construction stands for high load capacity, extraordinary casing stability, and an extended tire life. The special sidewall rib provides exceptional protection against impacts and the effects of tire rubbing, while the hexagonal bead with chafer reinforcement makes sure that the tire perfectly fits on the rim. In addition, the multi-block tread pattern ensures reduced rolling resistance, a uniform contact pressure, and smooth roadability. Thanks to all these features, POWERTRAILER SR 331 is synonym for fuel economy and road comfort.

Ø 22.5"	Tire size	RIM		S.W. (mm)	O.D. (mm)	SLR (mm)	RC (mm)	Version	PR	Type	LI/SS	Load capacity (kg/tire)	
		Rec.	Alt.									km/h - bar	
	560/60 R 22.5	AG 16.00	17.00 ; AG18.00	555	1245	565	3775	IMP	-	TL	165 D	65	5150

IMP: Implement

Technologies

- All Steel Radial
- Heavy Duty
- Reinforced Bead
- Reinforced Carcass
- Block Pattern
- Performance
- Road Oriented
- Traction
- High Load Capacity
- Stability
- Durability
- Low Rolling
- Fuel Economy
- Comfort
- Excellent flotation
- Cut and Chip Resistance



Bias



GF 305 FARM TRAILER

GF 305 FARM TRAILER has been designed for implements in transport operations. This tire is naturally gentle on the ground and protects the field against damage.

Ø 10"	Tire size	RIM		S.W. (mm)	O.D. (mm)	SLR (mm)	RC (mm)	Version	PR	Type	LI/SS	Load capacity (kg/tire)	
		Rec.	Alt.									km/h - bar	
	205/65 - 10 (20.5 x 8.00 - 10)	6.00	-	212	520	223	1508	STD	10	TL	-	40	6.20 695

Performance



Field Protection

STD: Standard





INDUSTRIAL RIB F3 (F-3)

INDUSTRIAL RIB F3 is an agro-industrial rib-pattern tire designed for field and road transport as well as for soil tillage operations with implement machinery and trailers. This tire features an outstanding stubble-resistant compound making it suitable for the most critical operating conditions and ensuring a long tire life-cycle.

Ø 15"	Tire size	RIM		S.W. (mm)	O.D. (mm)	SLR (mm)	RC (mm)	Version	PR	Type	LI/SS	Load capacity (kg/tire)	
		Rec.	Alt.									km/h - bar	
Ø 15"	11L - 15 SL	8 LB	10 LB	279	813	-	-	STD	12	TL	117 A6	4.20	
												30	1290
												40	1160
Ø 15"	11L - 15 SL	8 LB	10 LB	279	813	-	-	STD	10	TL	114 A6	3.60	
												30	1185
												40	1060
Ø 15"	11L - 15 SL	8 LB	10 LB	279	813	-	-	SR	10	TL	114 A6	3.60	
												30	1185
												40	1060
Ø 15"	11L - 15 SL	8 LB	10 LB	279	813	-	-	SR	12	TL	117 A6	4.20	
												30	1290
												40	1160
Ø 16"	11L - 16 SL	W 8 L	8 LB ; 10 LB ; W 10 L	279	830	-	-	STD	12	TL	120 A6	4.40	
												30	1385
												40	1250
Ø 16"	11L - 16 SL	W 8 L	8 LB ; 10 LB ; W 10 L	279	830	-	-	STD	10	TL	116 A6	3.60	
												30	1250
												40	1120
Ø 16"	11L - 16 SL	W 8 L	8 LB ; 10 LB ; W 10 L	279	830	-	-	SPL	10	TL	116 A6	3.60	
												30	1250
												40	1120

Technologies



Performance



STD: Standard - SR: Stubble Resistant - SPL: Special

I - 1



I-1 has been designed for field and road transport as well as for soil tillage operations with implements and trailers. I-1 is a high-speed tire that optimizes travel times so that you can focus on your core business. The special tread design ensures a long service life also in harsh conditions and if there is stubble in the fields.

Ø 14"	Tire size	RIM		S.W. (mm)	O.D. (mm)	SLR (mm)	RC (mm)	Version	PR	Type	LI/SS	Load capacity (kg/tire)	
		Rec.	Alt.									km/h - bar	3.00
9.5L - 14 SL	7.00	8 KB	237	745	326	2154	STD	8	TT	111 D	65	1090	
9.5L - 14 SL	7.00	8 KB	237	745	326	2154	STD	8	TL	111 D	65	1090	
11L - 14 SL	8.00	8 KB	256	753	333	2206	STD	8	TL	112 D	65	1120	

Ø 15"	Tire size	Rec.	Alt.	S.W. (mm)	O.D. (mm)	SLR (mm)	RC (mm)	Version	PR	Type	LI/SS	Load capacity (kg/tire)	
												km/h - bar	3.00
6.70 - 15 SL	4½ KB	5 KB	172	710	319	2080	STD	6	TL	97 D	65	730	
6.70 - 15 SL	4½ KB	5 KB	172	710	319	2080	STD	6	TT	97 D	65	730	
6.70 - 15 SL	4½ KB	5 KB	172	710	319	2080	STD	8	TT	102 D	65	850	
7.60 - 15 SL	-	6 LB	193	734	328	2151	STD	6	TT	100 D	65	800	
7.60 - 15 SL	-	6 LB	193	734	328	2151	STD	8	TT	106 D	65	950	
7.60 - 15 SL	-	6 LB	193	734	328	2151	STD	10	TT	110 D	65	1060	

Technologies





Performance



STD: Standard



Ø 15"	Tire size	RIM		S.W. (mm)	O.D. (mm)	SLR (mm)	RC (mm)	Version	PR	Type	LI/SS	Load capacity (kg/tire)	
		Rec.	Alt.									km/h - bar	
													
7.60 - 15 SL	-	6 LB	193	734	328	2151	STD	10	TL	110 D		65	4.30 1060
7.60 - 15 SL	-	6 LB	193	734	328	2151	STD	8	TL	106 D		65	3.60 950
9.5L - 15 SL	-	8 LB	241	765	340	2242	STD	6	TT	105 D		65	2.20 925
9.5L - 15 SL	-	8 LB	241	765	340	2242	STD	8	TT	112 D		65	3.00 1120
9.5L - 15 SL	-	8 LB	241	765	340	2242	STD	8	TL	112 D		65	3.00 1120
9.5L - 15 SL	-	8 LB	241	765	340	2242	STD	12	TL	121 D		65	4.40 1450
9.5L - 15 SL	7.00	8 LB	241	765	340	2242	SR	8	TL	112 D		65	3.00 1120
9.5L - 15 SL	7.00	8 LB	241	765	340	2242	SR	12	TL	121 D		65	4.40 1450
11L - 15 SL	8 LB	10 LB	270	770	342	2256	STD	8	TT	113 D		65	2.50 1150
11L - 15 SL	8 LB	10 LB	270	770	342	2256	STD	8	TL	113 D		65	2.50 1150
11L - 15 SL	8 LB	10 LB	270	770	342	2256	STD	10	TT	118 D		65	3.00 1320

Technologies



High Speed

Performance



Durability



Stubble Resistance

STD: Standard - SR: Stubble Resistant





Ø 15"	Tire size	RIM		S.W. (mm)	O.D. (mm)	SLR (mm)	RC (mm)	Version	PR	Type	LI/SS	Load capacity (kg/tire)	
		Rec.	Alt.									km/h - bar	
11L - 15 SL	8 LB	10 LB	270	770	342	2256	STD	10	TL	118 D		65	3.00 1320
11L - 15 SL	8 LB	10 LB	270	770	342	2256	STD	12	TL	121 D		65	3.60 1450
11L - 15 SL	8 LB	10 LB	270	770	342	2256	SR	8	TL	113 D		65	2.50 1150
11L - 15 SL	8 LB	10 LB	270	770	342	2256	SR	12	TL	121 D		65	3.60 1450
12.5L - 15 SL	10 LB	-	310	820	362	2403	STD	10	TL	-		65	3.00 1550
12.5L - 16 SL	10 LB	-	310	820	362	2403	STD	12	TT	-		65	3.60 1750
12.5L - 16 SL	10 LB	-	310	820	362	2403	STD	12	TL	-		65	3.60 1750
12.5L - 15 SL	10 LB	-	310	820	362	2403	STD	8	TT	119 D		65	2.50 1360
12.5L - 15 SL	10 LB	-	310	820	362	2403	STD	8	TL	119 D		65	2.50 1360
12.5L - 15 SL	10 LB	-	310	820	362	2403	STD	10	TT	123 D		65	3.00 1550
12.5L - 15 SL	10 LB	-	310	820	362	2403	SR	12	TL	-		65	3.60 1750

Technologies



High Speed

Performance



Durability



Stubble Resistance

STD: Standard - SR: Stubble Resistant





Ø 15.3"	Tire size	RIM		S.W. (mm)	O.D. (mm)	SLR (mm)	RC (mm)	Version	PR	Type	LI/SS Free Rolling	Load capacity (kg/tire)	
		Rec.	Alt.									km/h - bar	
10.0/75 - 15.3	9.00	-	270	765	-	-	STD	12	TT	118 D		65	4.70
													1320
10.0/75 - 15.3	9.00	-	270	765	-	-	STD	12	TL	118 D		65	4.70
													1320
Ø 16"	Tire size	Rim	Alt.	S.W. (mm)	O.D. (mm)	SLR (mm)	RC (mm)	Version	PR	Type	LI/SS Free Rolling	Load capacity (kg/tire)	
												km/h - bar	
7.50 - 16 SL	5.50 F	6 LB	205	785	350	2300	STD	8	TT	-		65	3.30
													1060
7.50 - 16 SL	5.50 F	6 LB	205	785	350	2300	STD	10	TT	-		65	4.10
													1215
7.50 - 16 SL	5.50 F	6 LB	205	785	350	2300	SPL	8	TT	-		65	3.30
													1060
7.50 - 16 SL	5.50 F	6 LB	205	785	350	2300	SPL	10	TT	-		65	4.10
													1215
9.00 - 16 SL	6 LB	8 LB ; W 8 L	234	845	374	2476	STD	10	TL	-		65	3.60
													1500
9.00 - 16 SL	6 LB	8 LB ; W 8 L	234	845	374	2476	STD	10	TT	-		65	3.60
													1500
11L - 16 SL	8 LB	10 LB ; W 8 L	270	795	355	2329	STD	8	TT	-		65	2.50
													1215
11L - 16 SL	8 LB	10 LB ; W 8 L	270	795	355	2329	STD	10	TT	-		65	3.00
													1360
11L - 16 SL	8 LB	10 LB ; W 8 L	270	795	355	2329	STD	12	TT	-		65	3.50
													1490

Technologies



High Speed

Performance



Durability



Stubble Resistance

STD: Standard - SPL: Special



Ø 16"	Tire size	RIM		S.W. (mm)	O.D. (mm)	SLR (mm)	RC (mm)	Version	PR	Type	LI/SS Free Rolling	Load capacity (kg/tire)	
		Rec.	Alt.									km/h - bar	
Ø 16"	12.5L - 16 SL	10 LB	W 10 L	310	845	374	2476	STD	8	TT	-	65	2.50 1400
	12.5L - 16 SL	10 LB	W 10 L	310	845	374	2476	STD	10	TT	-	65	3.00 1600
	12.5L - 16 SL	10 LB	W 10 L	310	845	374	2476	STD	12	TT	-	65	3.60 1800
	12.5L - 16 SL	10 LB	W 10 L	310	845	374	2476	STD	12	TL	-	65	3.60 1800
	12.5L - 16 SL	10 LB	W 10 L	310	845	374	2476	SR	14	TL	-	65	3.90 1900
Ø 16.1"	14L - 16.1 SL	W 11 C	-	360	935	409	2740	STD	12	TL	-	65	3.00 2120
	14L - 16.1 SL	W 11 C	-	360	935	409	2740	STD	8	TL	-	65	2.20 1750
	16.5L - 16.1 SL	W 14 C	W 14 CH	435	1025	444	3003	STD	10	TL	138 D	65	2.50 2360
	16.5L - 16.1 SL	W 14 C	W 14 CH	435	1025	444	3003	STD	14	TL	145 D	65	3.30 2900
	19L - 16.1 SL	W 16 C	W 16 CH	490	1100	474	3223	STD	10	TL	-	65	2.20 2725
	19L - 16.1 SL	W 16 C	W 16 CH	490	1100	474	3223	STD	14	TL	-	65	2.80 3150

Technologies

Performance

STD: Standard -SR: Stubble Resistant





Ø 16.1"	Tire size	RIM		S.W. (mm)	O.D. (mm)	SLR (mm)	RC (mm)	Version	PR	Type	LI/SS Free Rolling	Load capacity (kg/tire)		
		Rec.	Alt.									km/h - bar		
Ø 16.1"	19L - 16.1 SL	W 16 C	W 16 CH	490	1100	474	3223	STD	12	TL	-	65	2.50	3000
	21.5L - 16.1 SL	W 18 CH	W 16 CH	570	1150	495	3510	STD	8	TL	-	km/h - bar	1.70	
												65	2725	
	21.5L - 16.1 SL	W 18 CH	W 16 CH	570	1150	495	3510	STD	18	TL	-	km/h - bar	3.00	
												65	4000	
21.5L - 16.1 SL	W 18 CH	W 16 CH	570	1150	495	3510	STD	14	TL	-	km/h - bar	2.50		
											65	3550		
21.5L - 16.1 SL	W 18 CH	W 16 CH	570	1150	495	3510	SR	8	TL	143 D	km/h - bar	1.70		
											65	2725		
Ø 18"	10.5/80 - 18	W 9	W 8 ; 9	280	890	417	2679	STD	12	TT	135 A8	km/h - bar	4.40	
												10 FR	3050	
												25 FR	2595	
												30 FR	2440	
												40 FR	2180	
Ø 24"	9.00 - 24 SL	W 8 H	-	272	1094	-	-	SR	8	TL	-	km/h - bar	2.80	
												65	1600	
	11.25 - 24 SL	W 10 H	W 10 ; W 8	325	1171	-	-	STD	8	TL	-	km/h - bar	2.20	
65												1850		

STD: Standard -SR: Stubble Resistant

Technologies



High Speed

Performance



Durability



Stubble Resistance





TRAILER

Bias



AGRI GRIP

AGRI GRIP is a tire for transport operations and particularly suitable for sugarcane trailers. AGRI GRIP has a strong casing providing high load capacity and particular cut-and-chip resistance. Its tread pattern has been designed for a longer service life.

Ø 26"	Tire size	RIM		S.W. (mm)	O.D. (mm)	SLR (mm)	RC (mm)	Version	PR	Type	LI/SS	Load capacity (kg/tire)	
		Rec.	Alt.									km/h - bar	
23.1 - 26	DW 20 B	-	595	1560	708	4658	DB	18	TL	-	30 FR LLV	2.60	5600

DB: Dual Bead

Technologies



Special Compound

Performance



Cut and Chip Resistance



Durability



High Load Capacity





TRAILER

Bias



FARM HIGHWAY TOUGH

FARM HIGHWAY TOUGH is a high-speed tire designed for transport and soil tillage applications with trailers and implement machinery. It provides high load capacity also at high speeds and ensures a long tire life-cycle.

Ø 15"	Tire size	RIM		S.W. (mm)	O.D. (mm)	SLR (mm)	RC (mm)	Version	PR	Type	LI/SS	Load capacity (kg/tire)	
		Rec.	Alt.									km/h - bar	
	9.5L - 15 FI	7.00	8 LB	245	766	343	2183	STD	8	TL	-	100	1215
	9.5L - 15 FI	7.00	8 LB	245	766	343	2183	STD	12	TL	-	100	1550
	10.00 - 15 FI	8 LB	-	274	853	-	-	STD	8	TL	128 J	100	1800
	11L - 15 FI	8 LB	10 LB; 8 J	279	777	347	2214	STD	12	TL	128 J	100	1800
	11L - 15 FI	8 LB	10 LB; 8 J	279	777	347	2214	STD	8	TL	120 J	100	1400
	12.5L - 15 FI	10 LB	-	317	815	362	2323	STD	12	TL	134 J	100	2120

Technologies



Performance



STD: Standard



Bias



BK 208

BK 208 is suitable for transport applications on trailers and light trucks. It is a considerably durable and reliable tire for both in-the-field and on-the-road usage.

Ø 16"	Tire size	RIM		S.W. (mm)	O.D. (mm)	Version	PR	Type	Load capacity (kg/tire)	
		Rec.	Alt.						km/h - bar	
7.50 - 16	6.00 G	-	212	810	STD	12	TT	6.20	1400	
								100 LS	1250	
								100 LD		
7.50 - 16	6.00 G	-	212	810	STD	14	TT	6.90	1500	
								100 LS	1320	
								100 LD		
7.50 - 16	6.00 G	-	212	810	STD	16	TT	7.60	1600	
								100 LS	1400	
								100 LD		

STD: Standard

Performance



Bias



BK 308

BK 308 has been specially designed for trailers and utility tractors. It features excellent traction on all surfaces and tread tie bars to reduce tread groove cracking. The strong casing provides excellent durability and puncture resistance whereas the special tread compound ensures a longer service life.

Ø 20"	Tire size	RIM		S.W. (mm)	O.D. (mm)	SLR (mm)	RC (mm)	Version	PR	Type	LI/SS	Load capacity (kg/tire)	
		Rec.	Alt.									km/h - bar	
6.50 - 20	5.50 F	4.00 E ; 5.00 F		190	865	-	-	STD	10	TT	112 A6	4.8	1120
		30											

STD: Standard

Performance





Bias



BK 627

BK 627 is a block pattern tire suitable for transport and soil tillage operations with trailers and implement machinery. It is mainly field oriented and ideal for heavy-duty service.

Ø 16"	Tire size	RIM		S.W. (mm)	O.D. (mm)	SLR (mm)	RC (mm)	Version	PR	Type	LI/SS	Load capacity (kg/tire)	
		Rec.	Alt.									km/h - bar	
	7.50 - 16	6.0	-	220	810	365	2495	STD	12	TT	121 A8	40	1450

Performance



STD: Standard



Bias



BK 823

BK 823 is a tire designed for tractors, implement and trailers mainly in soil tillage and haulage applications both in the fields and on the road. Its special block pattern makes the tire particularly suitable for heavy-duty service where excellent steering performance is required. An HD version is also available with improved cut and chip resistance.

Ø 16"	Tire size	RIM		S.W. (mm)	O.D. (mm)	SLR (mm)	RC (mm)	Version	PR	Type	LI/SS	Load capacity (kg/tire)	
		Rec.	Alt.									km/h - bar	
	9.00 - 16	6.5	-	245	891	394	2583	STD	12	TT	124 A8	40	1600
	9.00 - 16	6.5	-	245	891	394	2583	STD	14	TT	127 A8	40	1750
	9.00 - 16	6.5	-	245	891	394	2583	STD	10	TL	121 A8	40	1450
	9.00 - 16	6.5	-	245	891	394	2583	HD	14	TT	127 A8	40	1750

Technologies



Performance



STD: Standard -HD: Heavy Duty



BK 826

BK 826 has been specially designed for trailers in haulage applications. It is a bias tire featuring high load capacity thanks to its reinforced carcass. BK 826 is also available as "industrial" version that shows particular cut and chip resistance and is also suitable for backhoe loaders.

Ø 16"	Tire size	RIM		S.W. (mm)	O.D. (mm)	SLR (mm)	RC (mm)	Version	PR	Type	LI/SS	Load capacity (kg/tire)	
		Rec.	Alt.									km/h - bar	
8.25 - 16	6.50 H 6.00 G	238	863	-	-	STD	14	TT	-			6.90	
												100 LS	1745
												100 LD	1650
8.25 - 16	6.50 H 6.00 G	238	863	-	-	STD	16	TT	-			7.60	
												100 LS	1850
												100 LD	1750
8.25 - 16	6.50 H 6.00 G	238	863	-	-	STD	18	TT	-			7.95	
												100 LS	1900
												100 LD	1800
8.25 - 16	6.50 H 6.00 G	238	863	-	-	STD	8	TT	-			4.25	
												100 LS	1350
												100 LD	1275
8.25 - 16	6.50 H 6.00 G	238	863	-	-	IND	18	TT	-			7.95	
												100 LS	1900
												100 LD	1800
8.25 - 16	6.50 H 6.00 G	238	863	-	-	IND	16	TT	-			8.40	
												40 LS	2130
												40 LD	2015
8.25 - 16	6.50 H 6.00 G	238	863	-	-	TR TR	16	TT	134A8			7.60	
												40	2120
9.00 - 16	6.50 H 6.00 G	265	925	-	-	STD	12	TT	-			5.15	
												30	1900

Technologies



Performance



STD: Standard - IND: Industrial - TR TR: Tractor Trailer





TRAILER

BK 826

Ø 16"	Tire size	RIM		S.W. (mm)	O.D. (mm)	SLR (mm)	RC (mm)	Version	PR	Type	LI/SS	Load capacity (kg/tire)	
		Rec.	Alt.									km/h - bar	6.20
9.00 - 16	6.50 H	6.00 G		265	925	-	-	STD	14	TT	-	30	2120
9.00 - 16	6.50 H	6.00 G		265	925	-	-	STD	16	TT	-	30	2300
9.00 - 16	6.50 H	6.00 G		265	925	-	-	STD	18	TT	-	30	2360
9.00 - 16	6.50 H	6.00 G		265	925	-	-	IND	16	TT	-	30	2300
9.00 - 16	6.50 H	6.00 G		265	925	-	-	SPL	12	TT	-	30	1900
9.00 - 16	6.50 H	6.00 G		265	925	-	-	TR TR	18	TT	138 A6	30	2360
9.00 - 16	6.50 H	6.00 G		265	925	-	-	TR TR	18	TT	138 A8	30	2360

STD: Standard - IND: Industrial - SPL: Special - TR TR: Tractor Trailer

Technologies



Reinforced Carcass

Performance



Cut and Chip Resistance



High Load Capacity







TRAILER

 Bias



BK RUF N TUF

BK RUF N TUF is a block pattern tire suitable for transport operations with trailers and light trucks. It is ideal for road usage and ensures excellent durability.

Ø 16"	Tire size	RIM		S.W. (mm)	O.D. (mm)	Version	PR	Type	Load capacity (kg/tire)	
		Rec.	Alt.						km/h - bar	
										
7.50 - 16	6.00 G	5.50 F	216	830	STD	8	TT	4.15		
								100 LS	1120	
								100 LD	975	
7.50 - 16	6.00 G	5.50 F	216	830	STD	12	TT	6.20		
								100 LS	1400	
								100 LD	1250	
7.50 - 16	6.00 G	5.50 F	216	830	STD	14	TT	6.90		
								100 LS	1500	
								100 LD	1320	
7.50 - 16	6.00 G	5.50 F	216	830	STD	16	TT	7.60		
								100 LS	1600	
								100 LD	1400	
7.50 - 16	6.00 G	5.50 F	216	830	STD	14	TL	6.90		
								100 LS	1500	
								100 LD	1320	

Performance



Durability

STD: Standard





TRAILER

Bias



SL 441

SL 441 is a tire developed for soil tillage and haulage operations with trailers and implement machinery. SL 441 has been engineered to offer great load capacity and a long tire life-cycle.

Ø 14.5"	Tire size	RIM		S.W. (mm)	O.D. (mm)	SLR (mm)	RC (mm)	Version	PR	Type	LI/SS	Load capacity (kg/tire)	
		Rec.	Alt.									km/h - bar	
200/60 - 14.5	6.75	4.50 E ; 5.50 F	210	610	278	1785	STD	10	TT	106 A8		5.00	
												10 FR	1330
												25 FR	1130
												30 FR	1065
												40 FR	950
200/60 - 14.5	6.75	4.50 E ; 5.50 F	210	610	278	1785	STD	14	TL	113 A8		7.00	
												10 FR	1610
												25 FR	1370
												30 FR	1290
												40 FR	1150
200/60 - 14.5	6.75	4.50 E ; 5.50 F	210	610	278	1785	STD	14	TT	113 A8		7.00	
												10 FR	1610
												25 FR	1370
												30 FR	1290
												40 FR	1150

STD: Standard

Performance



Durability



High Load Capacity



ST 180



ST 180 is a tire developed for haulage applications with trailers and implements. Its specific tread pattern ensures a long tire life-cycle due to reduced wear. ST 180 is available in different versions: an "aramid belted" version ensures improved puncture resistance, while the "special" version provides high cut and chip resistance.

Ø 8"	Tire size	RIM		S.W. (mm)	O.D. (mm)	SLR (mm)	RC (mm)	Version	PR	Type	LI/SS	Load capacity (kg/tire)	
		Rec.	Alt.									km/h - bar	
Ø 8"	4.80 - 8	3.75 - I - 55	3.75 - I - 70	121	418	-	-	STD	6	TL	-	100	6.20 345
	5.70 - 8	4.50 - I - 55	I - 70; I - 90; 3.75	142	475	-	-	STD	6	TL	-	km/h - bar	5.20
												100	412
5.70 - 8	4.50 - I - 55	I - 70; I - 90; 3.75	142	475	-	-	STD	8	TL	-	km/h - bar	6.90	
											100	487	
Ø 9"	6.00 - 9	4.00 - I - 55	4.50 - I - 55; I - 70; I - 90	165	540	-	-	STD	8	TT	-	km/h - bar	5.90
	6.00 - 9	4.00 - I - 55	4.50 - I - 55; I - 70; I - 90	165	540	-	-	STD	8	TL	-	100	630
												km/h - bar	5.90
	6.00 - 9	4.00 - I - 55	4.50 - I - 55; I - 70; I - 90	165	540	-	-	STD	10	TL	-	km/h - bar	6.90
												100	690
	6.00 - 9	4.00 - I - 55	4.50 - I - 55; I - 70; I - 90	165	540	-	-	STD	12	TT	-	km/h - bar	7.90
100												830	
6.00 - 9	4.00 - I - 55	4.50 - I - 55; I - 70; I - 90	165	540	-	-	STD	12	TL	-	km/h - bar	7.90	
											100	830	
Ø 10"	5.00 - 10	3.5	-	142	530	-	-	STD	6	TL	-	km/h - bar	3.00
												100	390

Technologies











Performance



STD: Standard



Ø 13"	Tire size	RIM		S.W. (mm)	O.D. (mm)	SLR (mm)	RC (mm)	Version	PR	Type	LI/SS	Load capacity (kg/tire)	
		Rec.	Alt.									km/h - bar	2.50
													
	ST 165/80 D 13 (A 78 - 13)	4½ J	5 J; 5½ J; 6 J	156	597	272	1746	STD	4	TL	-	40	450
	ST 175/80 D 13 (B 78 - 13)	5 J	4½ J; 5½ J; 6 J	175	620	286	1845	STD	4	TL	-	km/h - bar 40	2.50 500
	ST 175/80 D 13 (B 78 - 13)	5 J	4½ J; 5½ J; 6 J	175	620	286	1845	STD	6	TL	-	km/h - bar 40	3.50 615
	ST 175/80 D 13 (B 78 - 13)	5 J	4½ J; 5½ J; 6 J	175	620	286	1845	STD	8	TL	-	km/h - bar 40	4.50 710
Ø 14"	Tire size	RIM		S.W. (mm)	O.D. (mm)	SLR (mm)	RC (mm)	Version	PR	Type	LI/SS	Load capacity (kg/tire)	
		Rec.	Alt.									km/h - bar	2.50
													

Technologies

Aramid Belted



Special Compound

Performance

Cut and Chip Resistance



High Puncture Resistance

STD: Standard





TRAILER

ST 180

Ø 14"	Tire size	RIM		S.W. (mm)	O.D. (mm)	SLR (mm)	RC (mm)	Version	PR	Type	LI/SS	Load capacity (kg/tire)	
		Rec.	Alt.									km/h - bar	
												5.50	
	ST 215/75 D 14 (G 78 - 14)	6 J	5½ J; 6½ J; 7 J	205	682	320	2073	AB	10	TL	-	40	1120
	ST 215/75 D 14 (G 78 - 14)	6 J	5½ J; 6½ J; 7 J	205	682	320	2073	SPL	10	TL	-	40	1120
												5.50	
												40	1120
												3.50	
	ST 205/65 D 15 (F 65 - 15)	6 J	5½ J; 6½ J	193	648	303	1935	STD	6	TL	-	40	825
	ST 205/75 D 15 (F 78 - 15)	5½ J	5 J; 6 J; 7 J	195	702	327	2103	STD	4	TL	-	40	670
	ST 205/75 D 15 (F 78 - 15)	5½ J	5 J; 6 J; 7 J	195	702	327	2103	STD	6	TL	-	40	825
	ST 225/75 D 15 (H 78 - 15)	6 J	5½ J; 6½ J; 7 J	217	730	337	2178	STD	6	TL	-	40	975
	ST 225/75 D 15 (H 78 - 15)	6 J	5½ J; 6½ J; 7 J	217	730	337	2178	STD	8	TL	-	40	1150

STD: Standard - AB: Aramid Belted - SPL: Special

Technologies



Aramid Belted



Special Compound

Performance



Cut and Chip Resistance



High Puncture Resistance





TR 387 (R-3)

TR 387 is an agro-industrial tire suitable for sugar cane trailers and compactors. It features high load capacity and is available in different versions to meet specific user requirements in terms of cut and chip resistance, heavy-duty services and durability. The "dual bead" version is particularly suitable for industrial tractors and transport operations using trailers.

Ø 24"	Tire size	RIM		S.W. (mm)	O.D. (mm)	SLR (mm)	RC (mm)	Version	PR	Type	LI/SS	Load capacity (kg/tire)		
		Rec.	Alt.									km/h - bar		
	11.2 - 24	W 10	W 9	292	1075	496	3228	STD	-	TL	116 A6	30	2.40	1250
	18.4 - 26	DW 16 L	DW 15 L	485	1450	635	4150	STD	10	TL	142 A6	30	1.80	2650
	18.4 - 26	DW 16 L	DW 15 L	485	1450	635	4150	STD	12	TL	146 A6	30	2.30	3000
	18.4 - 26	DW 16 L	DW 15 L	485	1450	635	4150	HD	16	TL	152 A6	30	2.90	3550
	23.1 - 26	DW 20 B	-	592	1560	690	4688	STD	8	TL	145 A6	30	1.10	2900
	23.1 - 26	DW 20 B	-	592	1560	690	4688	STD	12	TL	153 A6	30	1.70	3650
	23.1 - 26	DW 20 B	-	592	1560	690	4688	STD	16	TL	159 A6	30	2.30	4375
	23.1 - 26	DW 20 B	-	592	1560	690	4688	DB	16	TL	159 A6	30	2.30	4375
	23.1 - 26	DW 20 B	-	592	1560	690	4688	DB HD	18	TT	161 A6	30	2.60	4625

Performance









Durability



High Load Capacity

STD: Standard - HD: Heavy Duty - DB: Dual Bead - DB HD: Dual Bead HD

TR 387 (R-3)

Ø 26"	Tire size	RIM		S.W. (mm)	O.D. (mm)	SLR (mm)	RC (mm)	Version	PR	Type	LI/SS	Load capacity (kg/tire)	
		Rec.	Alt.									km/h - bar	
												30	2.60
	23.1 - 26	DW 20 B	-	592	1560	690	4688	DB HD	18	TL	161 A6	30	4625
	23.1 - 26	DW 20 B	-	592	1560	690	4688	HD	12	TL	164 A6	30	1.70
												30	5000
	23.1 - 26	DW 20 B	-	592	1560	690	4688	HD DB SPL	18	TL	161 A6	30	2.60
												30	4625
Ø 28"	Tire size	Rec.	Alt.	S.W. (mm)	O.D. (mm)	SLR (mm)	RC (mm)	Version	PR	Type	LI/SS	Load capacity (kg/tire)	
												km/h - bar	
	12.4 - 28	W 11	W 9;W 10	325	1200	550	3576	STD	8	TL	123 A6	30	2.30
												30	1550
	16.9 - 28	DW 15 L	DW 14 L	440	1400	630	4074	STD	8	TL	135 A6	30	1.70
												30	2180
Ø 30"	Tire size	Rec.	Alt.	S.W. (mm)	O.D. (mm)	SLR (mm)	RC (mm)	Version	PR	Type	LI/SS	Load capacity (kg/tire)	
												km/h - bar	
	16.9 - 30 (14 - 30)	DW 15 L	DW 14 L	440	1450	655	4220	STD	8	TL	137 A6	30	1.70
												30	2300
	18.4 - 30 (15 - 30)	DW 16 L	DW 15 L	475	1530	677	4511	STD	8	TL	139 A6	30	1.40
												30	2430
	18.4 - 30 (15 - 30)	DW 16 L	DW 15 L	475	1530	680	4395	HD	14	TT	151 A6	30	2.60
												30	3450
	620/75 - 30 (23.1 - 30)	DW 20 A; DW 20 B	-	605	1675	-	-	DB	16	TL	161 A6	30	2.30
												30	4625
	620/75 - 30 (23.1 - 30)	DW 20 A; DW 20 B	-	605	1675	-	-	DB HD	18	TL	164 A6	30	2.60
												30	5000
Ø 32"	Tire size	Rec.	Alt.	S.W. (mm)	O.D. (mm)	SLR (mm)	RC (mm)	Version	PR	Type	LI/SS	Load capacity (kg/tire)	
												km/h - bar	
	24.5 - 32	DH 21	DH 21 B; DH 21 H; DH 21 HB	625	1755	790	5226	DB HD	16	TL	164 A6	30	2.10
												30	5000

Performance

DB HD SPL: Dual Bead HD Special - DB HD: Dual Bead HD - STD: Standard - HD: Heavy Duty



TR 390 (R-3)

TR 390 is an agro-industrial tire suitable for sugar cane trailers and compactors. TR 390 features high load capacity and increased durability. Its "dual bead HD" version is particularly suitable for industrial tractors and transport operations using trailers, whereas its "dual bead HD special" version is ideal for heavy-duty service.

Ø 26"	Tire size	RIM		S.W. (mm)	O.D. (mm)	SLR (mm)	RC (mm)	Version	PR	Type	LI/SS	Load capacity (kg/tire)	
		Rec.	Alt.									km/h - bar	
23.1 - 26	DW 20 B	-	-	595	1560	690	4545	STD	8	TL	145 A6	30	1.10 2900
23.1 - 26	DW 20 B	-	-	595	1560	690	4545	STD	12	TL	153 A6	30	1.70 3650
23.1 - 26	DW 20 B	-	-	595	1560	690	4545	STD	16	TL	159 A6	30	2.30 4375
23.1 - 26	DW 20 B	-	-	595	1560	690	4545	DB HD	18	TL	161 A6	30	2.60 4625
23.1 - 26	DW 20 B	-	-	595	1560	690	4545	HD DB SPL	18	TL	161 A6	30	2.60 4625
28L - 26	DW 25 B	DW 23 B	-	714	1560	690	4545	STD	12	TL	154 A6	30	1.40 3750
28L - 26	DW 25 B	DW 23 B	-	714	1560	690	4545	DB	16	TL	160 A6	30	1.90 4500
28L - 26	DW 25 B	DW 23 B	-	714	1560	690	4545	DB HD	20	TL	172 A6	30	2.80 6300

DB HD SPL: Dual Bead HD Special - DB HD: Dual Bead HD - DB: Dual Bead - STD: Standard

Performance



Durability



High Load Capacity



Bias



TR 391 (R-3)

TR 391 is an agro-industrial tire suitable for transport and compacting operations with sugar cane trailers and compactors. TR 391 features high load capacity and a longer service life.

Ø 24"	Tire size	RIM		S.W. (mm)	O.D. (mm)	SLR (mm)	RC (mm)	Version	PR	Type	LI/SS	Load capacity (kg/tire)		
		Rec.	Alt.									km/h - bar		
													1.40	
14.9 - 24	DW 13	DW 11 ; DW 13 L ; DW 12		405	1270	574	3805	STD	6	TL	123 A6		30	1550
14.9 - 24	DW 13	DW 11 ; DW 12 ; DW 13 L		405	1270	574	3805	STD	8	TL	128 A6		30	1800

STD: Standard

Performance



Durability



High Load Capacity



Bias



AGRI TRAILER

AGRI TRAILER has been specially designed for tractor trailers. It is the ideal tire for modern farming, suitable for transport applications both on and off the road. Its robust construction results in high load capacity, whereas its extra-deep tread allows for a better mileage and a longer service life.

Ø 20"	Tire size	RIM		S.W. (mm)	O.D. (mm)	SLR (mm)	RC (mm)	Version	PR	Type	LI/SS	Load capacity (kg/tire)			
		Rec.	Alt.									km/h - bar			
													9.30		8.60
10.00 - 20	7.5	7.0 ; 8.0		286	1080	-	-	STD	18	TT	-		30 LS	3845	-
													30 LD	-	3405

STD: Standard

Technologies



Extra Deep Tread

Performance



Durability



High Load Capacity



High Mileage



Bias



RIB TRAILER

RIB TRAILER is a bias tire specially designed for on & off the road applications with implement machinery, particularly straw reapers. Its 4-rib design optimizes load distribution, and the strong casing ensures stubble resistance. RIB TRAILER has been designed with a special compound that ensure an excellent tire life thanks to its high wear resistance.

Ø 16"	Tire size	RIM		S.W. (mm)	O.D. (mm)	SLR (mm)	RC (mm)	Version	PR	Type	LI/SS	Load capacity (kg/tire)	
		Rec.	Alt.									km/h - bar	
	6.00 - 16	4.50 E	4.00 E; 5 K; 5.00 F	170	735	-	-	STD	8	TT	94 A6	30	670
												30	1550

Ø 19"	Tire size	Rec.	Alt.	S.W. (mm)	O.D. (mm)	SLR (mm)	RC (mm)	Version	PR	Type	LI/SS	Load capacity (kg/tire)	
												km/h - bar	
	7.00 - 19	5.00	-	210	875	-	-	STD	10	TT	119 A3	30	1550

STD: Standard

Technologies



Performance





ARROW

ARROW is suitable for transport applications with trailers. It is a road-oriented tire that provides a better mileage and a longer service life. ARROW has a high load capacity also at high speeds. An HD version made of a special compound is also available for users that require advanced performance.

Ø 14"	Tire size	RIM		S.W. (mm)	O.D. (mm)	Version	PR	Type	Load capacity (kg/tire)		
		Rec.	Alt.						km/h - bar	100 LS	100 LD
Ø 14"	6.50 - 14	4.5 J	-	175	695	STD	10	TT	5.00	925	815
									100 LS	925	815
									100 LD	925	815
	6.50 - 14 LT	4.5 J	-	175	695	HD	10	TT	5.00	925	815
									100 LS	925	815
									100 LD	925	815
Ø 16"	7.50 - 16	6.00 G	5.50 F	216	825	STD	12	TT	6.20	1400	1250
									100 LS	1400	1250
									100 LD	1400	1250
	7.50 - 16	6.00 G	5.50 F	216	825	STD	14	TT	6.90	1500	1320
									100 LS	1500	1320
									100 LD	1500	1320
	7.50 - 16	6.00 G	5.50 F	216	825	STD	16	TT	7.60	1600	1400
									100 LS	1600	1400
									100 LD	1600	1400
Ø 20"	9.00 - 20	7.0	6.5 ; 7.5	270	1040	STD	14	TT	7.60	2575	2240
									100 LS	2575	2240
									100 LD	2575	2240
	9.00 - 20	7.0	6.5 ; 7.5	270	1040	STD	16	TT	7.95	2650	2360
									100 LS	2650	2360
									100 LD	2650	2360

Technologies



Performance



STD: Standard - HD: Heavy Duty





TRAILER

ARROW

Ø 20"	Tire size	RIM		S.W. (mm)	O.D. (mm)	Version	PR	Type	Load capacity (kg/tire)		
		Rec.	Alt.						km/h - bar		
										7.25	
	9.00 - 20	7.0	6.5 ; 7.5	270	1040	TR TR	16	TT	40	2715	
									km/h - bar	7.95	7.25
	10.00 - 20	7.5	7.0 ; 8.0	286	1075	STD	16	TT	100 LS	3000	-
									100 LD	-	2650

STD: Standard - TR TR: Tractor Trailer

Technologies



High Speed



Special Compound

Performance



Durability



High Load Capacity



High Mileage





COLT

COLT is a block pattern tire suitable for transport with trailers and light trucks, both in the field and on the road. COLT ensures extended durability and high performance during the entire product life-cycle.

Ø 15"	Tire size	RIM		S.W. (mm)	O.D. (mm)	Version	PR	Type	Load capacity (kg/tire)	
		Rec.	Alt.						km/h - bar	
7.50 - 15	6.00	-	217	790	STD	12	TT	6.00	6.00	
								100 LS	1385	
								100 LD	1315	
7.50 - 15	6.00	-	217	790	STD	14	TT	6.50	6.50	
								100 LS	1450	
								100 LD	1375	
7.50 - 15	6.00	-	217	790	STD	16	TT	7.50	7.50	
								100 LS	1500	
								100 LD	1440	
Ø 16"	7.50 - 16	6.00 G	5.50 F	212	820	STD	16	TT	7.60	7.60
									100 LS	1600
									100 LD	1400
7.50 - 16	6.00 G	5.50 F	212	820	STD	14	TT	6.90	6.90	
								100 LS	1500	
								100 LD	1320	
7.50 - 16	6.00 G	5.50 F	212	820	IND	16	TT	8.40	8.40	
								40	1840	

STD: Standard - IND: Industrial

Performance



Durability



High Mileage



Traction



D 404

D 404 is a road-oriented tire ideal for transport applications with trailers and light trucks. An excellent grip on the road along with regular wear turns into extra durability.

Ø 14"	Tire size	RIM		S.W. (mm)	O.D. (mm)	Version	PR	Type	Load capacity (kg/tire)	
		Rec.	Alt.						km/h - bar	
Ø 14"	6.00 - 14	4.5 J	4 J ; 5 J	170	690	STD	8	TT	km/h - bar	4.25
									100 LS	750
									100 LD	710
	6.50 - 14	4.5 J	-	175	695	STD	8	TT	km/h - bar	4.30
									100 LS	840
									100 LD	795
	6.50 - 14	4.5 J	-	175	695	STD	10	TT	km/h - bar	5.00
									100 LS	925
									100 LD	815
Ø 15"	7.00 - 15	5.50 F	5 K	198	760	STD	8	TT	km/h - bar	4.15
									100 LS	925
									100 LD	825
	7.00 - 15	5.50 F	5 K	198	760	STD	10	TT	km/h - bar	5.15
									100 LS	1060
									100 LD	925
	7.00 - 15	5.50 F	5 K	198	760	STD	12	TT	km/h - bar	6.20
									100 LS	1180
									100 LD	1030
	7.50 - 15	6.00	-	220	785	STD	12	TT	km/h - bar	6.00
									100 LS	1385
									100 LD	1315
	7.50 - 15	6.00	-	220	785	STD	14	TT	km/h - bar	6.50
									100 LS	1450
									100 LD	1375

Performance





Durability



Road Oriented

STD: Standard



Ø 16"	Tire size	RIM		S.W. (mm)	O.D. (mm)	Version	PR	Type	Load capacity (kg/tire)	
		Rec.	Alt.						km/h - bar	
										
7.00 - 16	5.50 F	6.00 G	198	785	STD	10	TT	km/h - bar	5.15	
								100 LS	1090	
								100 LD	975	
7.00 - 16	5.50 F	6.00 G	198	785	STD	16	TT	km/h - bar	7.60	
								100 LS	1390	
								100 LD	1225	
7.00 - 16	5.50 F	6.00 G	198	785	STD	12	TT	km/h - bar	6.20	
								100 LS	1215	
								100 LD	1065	
7.50 - 16	6.00 G	5.50 F	212	820	STD	14	TT	km/h - bar	6.90	
								100 LS	1500	
								100 LD	1320	
7.50 - 16	6.00 G	5.50 F	212	820	STD	8	TT	km/h - bar	4.15	
								100 LS	1120	
								100 LD	975	
7.50 - 16	6.00 G	5.50 F	212	810	STD	12	TT	km/h - bar	6.20	
								100 LS	1215	
								100 LD	1060	
7.50 - 16	6.00 G	5.50 F	212	810	STD	16	TT	km/h - bar	7.60	
								100 LS	1600	
								100 LD	1400	
7.50 - 16	6.00 G	5.50 F	212	810	STD	10	TT	km/h - bar	5.15	
								100 LS	1250	
								100 LD	1090	

STD: Standard

Performance

Durability



Road Oriented



TRAILER

D 404

Ø 16"	Tire size	RIM		S.W. (mm)	O.D. (mm)	Version	PR	Type	Load capacity (kg/tire)	
		Rec.	Alt.						km/h - bar	
8.25 - 16	6.50 H	6.00 G	238	858	STD	8	TT	4.25	1350	
								100 LS	1275	
								100 LD		
8.25 - 16	6.50 H	6.00 G	238	858	STD	14	TT	6.90	1745	
								100 LS	1650	
								100 LD		
8.25 - 16	6.50 H	6.00 G	238	858	STD	16	TT	7.60	1850	
								100 LS	1750	
								100 LD		
8.25 - 16	6.50 H	6.00 G	238	858	STD	18	TT	7.95	1900	
								100 LS	1800	
								100 LD		

Performance



Durability



Road Oriented

STD: Standard





TRAILER

Bias



D 405

D 405 is a road-oriented tire ideal for transport applications with trailers and light trucks. An excellent grip on the road along with regular wear turns into extra durability.

Ø 16"	Tire size	RIM		S.W. (mm)	O.D. (mm)	Version	PR	Type	Load capacity (kg/tire)	
		Rec.	Alt.						km/h - bar	
7.50 - 16	6.00 G	5.50 F	212	810	STD	14	TT	km/h - bar	6.90	
								100 LS	1500	
								100 LD	1320	
7.50 - 16	6.00 G	5.50 F	212	810	STD	16	TT	km/h - bar	7.60	
								100 LS	1600	
								100 LD	1400	
7.50 - 16	6.00 G	5.50 F	212	810	STD	12	TT	km/h - bar	6.20	
								100 LS	1400	
								100 LD	1250	
9.00 - 16	6.50 H	6.00 G	255	925	STD	12	TT	km/h - bar	5.15	
								30	1900	
10.50 - 16	6.00 T	-	290	980	STD	14	TT	km/h - bar	6.90	
								100 LS	2575	
								100 LD	2300	

STD: Standard

Performance



Durability



Road Oriented





DON 2000

DON 2000 is a suitable for transport operations with trailers and light trucks both on and off the road. It ensures extra durability along with high performance during the entire product life-cycle.

Ø 16"	Tire size	RIM		S.W. (mm)	O.D. (mm)	SLR (mm)	RC (mm)	Version	PR	Type	LI/SS	Load capacity (kg/tire)		
		Rec.	Alt.									km/h - bar		
Ø 16"	7.50 - 16	6.00 G	5.50 F	216	840	-	-	STD	16	TT	-	7.60	1600	
													1400	
Ø 20"	9.00 - 20	7.0	6.5 ; 7.5	270	1048	-	-	STD	16	TT	-	7.95	7.25	
												100 LS	2650	-
												100 LD	-	2360
	9.00 - 20	7.0	6.5 ; 7.5	270	1048	-	-	TR TR	16	TT	-	7.25		
												40	2715	
	10.00 - 20	7.5	7.0 ; 8.0	286	1080	-	-	IND TR	16	TT	-	8.75	8.00	
												40 LS	3450	-
												40 LD	-	3050
	10.00 - 20	7.5	7.0 ; 8.0	286	1080	-	-	IND TR	18	TT	-	9.10	8.40	
												40 LS	3535	-
												40 LD	-	3135
	11.00 - 20	8.0	7.5	292	1110	520	3414	STD	18	TT	-	8.25	7.60	
												100 LS	3350	-
												100 LD	-	3000
	12.00 - 20	8.5	9.0	315	1145	535	3519	STD	18	TT	-	7.95	7.25	
												100 LS	3750	-
												100 LD	-	3350
	Ø 24"	12.00 - 24	8.5	8.0 ; 9.0	315	1245	-	-	STD	18	TT	-	7.95	7.25
100 LS													4250	-
100 LD													-	3750

Performance



STD: Standard - IND TRAILER: Industrial Trailer - TR TR: Tractor Trailer



TRAILER

Bias



FLOTATION V LINE

FLOTATION V LINE has been specially designed for trailers in transport applications. It shows high flotation capability and ensures low soil compaction protecting the field. FLOTATION V LINE allows you to carry high loads at low pressure maximizing your business productivity.

Ø 22.5"	Tire size	RIM		S.W. (mm)	O.D. (mm)	SLR (mm)	RC (mm)	Version	PR	Type	LI/SS Drive Wheel	LI/SS Free Rolling	Load capacity (kg/tire)			
		Rec.	Alt.										km/h - bar			
													1.50	2.00	2.40	2.80
500/60 - 22.5	AG 16.00	15.00 ; 17.00	500	1170	510	3489	STD	12	TL	145 A8/ 142 B	157 A8/ 154 B	10 FR	4390	5195	5775	
												20 FR	3950	4675	5200	
												30 FR	3510	4155	4620	
												40 FR	3135	3710	4125	
												50 FR	2820	3340	3750	
												10 DW	3085	3645	4060	
												20 DW	2780	3280	3655	
												30 DW	2470	2920	3250	
												40 DW	2205	2605	2900	
												50 DW	1985	2345	2650	
												10 FR	6315	6575	6825	
												20 FR	5685	5915	6145	
												30 FR	5050	5260	5460	
40 FR	4510	4695	4875													
50 FR	4060	4225	4375													
10 DW	4465	4650	4830													
20 DW	4020	4185	4345													
30 DW	3575	3720	3865													
40 DW	3190	3320	3450													
50 DW	2870	2990	3150													
550/60 - 22.5	AG 16.00	-	550	1240	540	3725	STD	12	TL	148 A8/ 144 B	160 A8/ 156 B	10 FR	5175	5755	6300	
												20 FR	4655	5180	5670	
												30 FR	4140	4605	5040	
												40 FR	3695	4110	4500	
												50 FR	3325	3700	4000	
												10 DW	3620	4030	4410	
												20 DW	3255	3630	3970	
												30 DW	2895	3225	3530	
												40 DW	2585	2880	3150	
												50 DW	2325	2590	2800	
												10 FR	6970	7310	7630	
												20 FR	6275	6575	6865	
												30 FR	5580	5845	6105	
40 FR	4980	5220	5450													
50 FR	4480	4700	4875													
10 DW	4795	5025	5250													
20 DW	4315	4525	4725													
30 DW	3835	4020	4200													
40 DW	3425	3590	3750													
50 DW	3085	3230	3350													

Performance



Field Protection



Excellent Flotation



Reduced Soil Compaction

STD: Standard



TRAILER

Bias



MT 612

MT 612 has been specially designed for multipurpose use on and off the road. Its strong casing allows carrying heavy loads at high speed whereas its broad lugs provide outstanding traction. The extra tread width ensures excellent flotation on sand and mud.

Ø 20"	Tire size	RIM		S.W. (mm)	O.D. (mm)	SLR (mm)	RC (mm)	Version	PR	Type	LI/SS	Load capacity (kg/tire)	
		Rec.	Alt.									km/h - bar	
14.00 - 20	10	-	390	1265	594	3827	STD	18	TT	-		6.60	
												4500	
												4000	
14.00 - 20	10	-	390	1265	594	3827	STD	22	TT	-		8.60	
												5300	
												4750	
14.00 - 20	10	-	390	1265	594	3827	STD	20	TT	-		7.60	
												4875	
												4375	
16.0/70 - 20	13.00 T	-	405	1095	520	3327	STD	16	TT	-		4.50	
												3075	
												2725	

STD: Standard

Performance





TRAILER

Bias



RM 2002

RM 2002 is suitable for transport operations with trailers and light trucks, both on and off the road. It ensures long durability and top performance along the entire product life-cycle. Its "industrial" version is ideal for pick & carry cranes.

Ø 20"	Tire size	RIM		S.W. (mm)	O.D. (mm)	SLR (mm)	RC (mm)	Version	PR	Type	LI/SS	Load capacity (kg/tire)		
		Rec.	Alt.									km/h - bar	7.95	7.25
11.00 - 20	8.0	7.5 ; 8.5	302	1101	-	-	STD	16	TT	-	-	100 LS	3250	-
												100 LD	-	2900
												km/h - bar	8.25	7.60
11.00 - 20	8.0	7.5 ; 8.5	302	1101	-	-	STD	18	TT	-	-	100 LS	3350	-
												100 LD	-	3000
												km/h - bar	8.25	7.60
11.00 - 20	8.0	7.5 ; 8.5	302	1101	-	-	IND	18	TT	-	-	100 LS	3350	-
												100 LD	-	3000
												km/h - bar	8.25	7.60
11.00 - 20	8.0	7.5 ; 8.5	302	1101	-	-	IND	16	TT	-	-	100 LS	3250	-
												100 LD	-	2900
												km/h - bar	7.95	7.25
12.00 - 20	8.5	8.0 ; 9.0	315	1145	534	3538	STD	18	TT	-	-	100 LS	3750	-
												100 LD	-	3350
												km/h - bar	7.95	7.25

STD: Standard - IND: Industrial

Performance



Durability





TRAILER

Bias



TUF LUG

TUF LUG is suitable for trailers and light trucks in transport applications. This tire offers good traction and great durability and ensures a long product life-cycle.

Ø 16"	Tire size	RIM		S.W. (mm)	O.D. (mm)	Version	PR	Type	Load capacity (kg/tire)	
		Rec.	Alt.						km/h - bar	
	7.50 - 16	6.00 G	5.50 F	216	830	STD	12	TT		
									km/h - bar	6.20
									100 LS	1400
									100 LD	1250
	7.50 - 16	6.00 G	5.50 F	216	830	STD	14	TT		
									km/h - bar	6.90
									100 LS	1500
									100 LD	1320
	7.50 - 16	6.00 G	5.50 F	216	830	STD	16	TT		
									km/h - bar	7.60
									100 LS	1600
									100 LD	1400

Performance



Durability



Traction

STD: Standard





TRAILER

Bias



VIJETA

VIJETA is an agricultural tire suitable for both on- and off-the-road applications. The 5-rib pattern optimizes load distribution. In addition, the wear-resistant compound and the strong casing stand for a long tire life-cycle.

Ø 19"	Tire size	RIM		S.W. (mm)	O.D. (mm)	SLR (mm)	RC (mm)	Version	PR	Type	LI/SS	Load capacity (kg/tire)		
		Rec.	Alt.									km/h - bar		
	5.00 - 19	3.00	-	140	755	-	-	STD	6	TT	94 A3	15	3.80	670
	6.00 - 19	4.00	-	175	810	-	-	STD	8	TT	105 A3	15	4.15	925
	7.00 - 19	5.00	-	195	852	-	-	STD	10	TT	-	15	5.15	1360
	8.00 - 19	5.00	-	225	912	-	-	STD	10	TT	-	15	5.15	1660

Technologies



Hard Compound



Strong Casing

Performance



Durability

STD: Standard



TRANSPORT

|| @ @ # @



MH TR 182

MH TR 182 is suitable for transport operations with mobile home vehicles. It is a road-oriented, high-speed tire that significantly reduces fuel consumption. MH TR 182 ensures long durability and high performance along the entire product life-cycle.



Ø 14.5"	Tire size	RIM		S.W. (mm)	O.D. (mm)	Version	PR	Type	Load capacity (kg/tire)	
		Rec.	Alt.						km/h - bar	
									100	4.80
8 - 14.5	6.00 MH	-	207	710	STD	8	TL		100	1030
8 - 14.5	6.00 MH	-	207	710	STD	10	TL		100	5.90
									100	1180
8 - 14.5	6.00 MH	-	207	710	STD	12	TL		100	6.90
									100	1285
8 - 14.5	6.00 MH	-	207	710	STD	14	TL		100	7.60
									100	1390

STD: Standard

Technologies



High Speed

Performance



Durability



Fuel Economy



Road Oriented





Bias

LT TR 182

LT TR 182 is suitable for transport operations on light trucks. This high-speed tire is road oriented and significantly reduces fuel consumption. The LT TR 182 tire is also easy to mount.



TRANSPORT

Ø 14.5"	Tire size	RIM		S.W. (mm)	O.D. (mm)	Version	PR	Type	Load capacity (kg/tire)	
		Rec.	Alt.						km/h - bar	
										6.90
	8 - 14.5	6.00 MH	-	207	710	STD	12	TL	100 LS	1285
									100 LD	1130
	8 - 14.5	6.00 MH	-	207	710	STD	14	TL	100 LS	1375
									100 LD	1210

STD: Standard

Technologies



High Speed

Performance



Durability



Fuel Economy



Road Oriented



ATV





Bias



W 207

W 207 is BKT's ATV tire for all-terrain sports. Thanks to M+S technology and a special design, it provides the best traction in any condition. This tire features an excellent puncture resistance over challenging terrains.

Ø 8"	Tire size	RIM		S.W. (mm)	O.D. (mm)	SLR (mm)	RC (mm)	Version	PR	Type	LI/SS	Load capacity (kg/tire)	
		Rec.	Alt.									km/h - bar	0.45
	AT 22 X 11 - 8	9.0 AT	8.5 AT	272	561	-	-	STD	6	TL	-	100	180
Ø 9"	AT 22 X 11 - 9	9.0 AT	8.5 AT	272	561	-	-	STD	6	TL	-	100	180
	AT 25 X 12 - 9	9.5 AT	9.0 AT ; 10.0 AT	300	632	-	-	STD	6	TL	-	100	224
	AT 25 X 13 - 9	10.5 AT	10.0 AT	330	635	-	-	STD	6	TL	-	80	243
Ø 10"	AT 22 X 7 - 10	5.5 AT	6.0 AT	178	559	-	-	STD	6	TL	-	100	115
	AT 22 X 8 - 10	6.5 AT	6.0 AT	203	559	-	-	STD	6	TL	-	100	125
	AT 22 X 11 - 10	9.0 AT	8.5 AT	272	561	-	-	STD	6	TL	-	100	175
	AT 23 X 7 - 10	5.5 AT	6.0 AT	177	584	-	-	STD	6	TL	-	100	125
	AT 23 X 8 - 10	6.5 AT	6.0 AT	203	589	-	-	STD	6	TL	-	80	136

STD: Standard

Technologies



Performance



Ø 10"	Tire size	RIM		S.W. (mm)	O.D. (mm)	SLR (mm)	RC (mm)	Version	PR	Type	LI/SS	Load capacity (kg/tire)	
		Rec.	Alt.									km/h - bar	
	AT 23 X 10 - 10	8.0 AT	7.5 AT; 8.5 AT	249	587	-	-	STD	6	TL	-	80	170
	AT 24 X 11 - 10	9.0 AT	8.5 AT	279	610	-	-	STD	6	TL	-	100	200
	AT 25 X 11 - 10	9.0 AT	8.5 AT	285	640	-	-	STD	6	TL	-	100	206
	AT 25 X 12 - 10	9.5 AT	9.0 AT; 10.0 AT	297	640	-	-	STD	6	TL	-	80	224
Ø 11"	AT 23 X 8 - 11	6.5 AT	6.0 AT	203	584	-	-	STD	6	TL	-	80	132
	AT 24 X 8 - 11	6.5 AT	6.0 AT	203	612	-	-	STD	6	TL	-	80	145
	AT 24 X 9 - 11	7.0 AT	7.5 AT	226	610	-	-	STD	6	TL	-	80	165
	AT 24 X 10 - 11	8.0 AT	7.5 AT; 8.5 AT	249	612	-	-	STD	6	TL	-	80	180
	AT 25 X 8 - 11	6.5 AT	6.0 AT	203	638	-	-	STD	6	TL	-	80	161
	AT 25 X 10 - 11	8.0 AT	7.5 AT; 8.5 AT	249	638	-	-	STD	6	TL	-	80	190
Ø 12"	AT 24 X 8 - 12	6.5 AT	6.0 AT	198	615	-	-	STD	6	TL	-	100	140

STD: Standard

Technologies



Performance



Ø 12"	Tire size	RIM		S.W. (mm)	O.D. (mm)	SLR (mm)	RC (mm)	Version	PR	Type	LI/SS	Load capacity (kg/tire)	
		Rec.	Alt.									km/h - bar	0.45
AT 25 X 8 - 12	6.5 AT	6.0 AT	198	638	-	-	STD	6	TL	-		100	155
AT 25 X 10 - 12	8.0 AT	6.5 AT ; 7.5 AT ; 8.5 AT	249	638	-	-	STD	6	TL	-		km/h - bar	0.45
												100	190
AT 25 X 11 - 12	9.0 AT	8.5 AT	284	638	-	-	STD	6	TL	-		km/h - bar	0.45
												100	206
AT 26 X 8 - 12	6.50 AT	6.00 AT	204	660	-	-	STD	6	TL	-		km/h - bar	0.45
												100	175
AT 26 X 10 - 12	8.0 AT	7.5 AT ; 8.5 AT	241	658	-	-	STD	6	TL	-		km/h - bar	0.45
												100	200
AT 26 X 12 - 12	9.5 AT	8.0 AT ; 8.5 AT ; 9.0 AT	299	658	-	-	STD	6	TL	-		km/h - bar	0.45
												100	236
AT 27 X 10 - 12	8.0 AT	7.5 AT ; 8.5 AT	241	683	-	-	STD	6	TL	-		km/h - bar	0.45
												100	222
AT 27 X 12 - 12	9.5 AT	8.5 AT ; 9.0 AT	299	683	-	-	STD	6	TL	-		km/h - bar	0.45
												100	250
AT 28 X 10 - 12	8.0 AT	7.5 AT ; 8.5 AT	241	706	-	-	STD	6	TL	-		km/h - bar	0.45
												100	231
AT 28 X 12 - 12	9.5 AT	8.5 AT ; 9.0 AT	299	706	-	-	STD	6	TL	-		km/h - bar	0.45
												100	258

STD: Standard

Technologies



Performance





Bias



AT 108

AT 108 is an all-terrain tire suitable for ATVs. Its tread design provides excellent comfort and performance on-and-off the road.

Ø	Tire size	RIM		S.W. (mm)	O.D. (mm)	SLR (mm)	RC (mm)	Version	PR	Type	LI/SS	Load capacity (kg/tire)		
		Rec.	Alt.									km/h - bar		
8"													0.35	
	AT 20 X 7 - 8	5.5 AT	6.0 AT	170	508	-	-	STD	4	TL	-	100	88	
	AT 22 X 11 - 8	9.0 AT	8.5 AT	277	560	-	-	STD	4	TL	-	100	155	
9"	AT 22 X 10 - 9	8.0 AT	7.5 AT ; 8.5 AT	254	559	-	-	STD	4	TL	-	100	136	
	AT 22 X 11 - 9	9.0 AT	8.5 AT	275	557	-	-	STD	4	TL	-	80	155	
	AT 22 X 11 - 9	9.0 AT	8.5 AT	275	557	-	-	STD	6	TL	-	100	180	
	AT 25 X 12 - 9	9.5 AT	9.0 AT ; 10.0 AT	292	640	-	-	STD	4	TL	-	100	195	
	AT 25 X 13 - 9	10.5 AT	10.0 AT	320	635	-	-	STD	4	TL	-	100	212	
	AT 25 X 13 - 9	10.5 AT	10.0 AT	320	635	-	-	STD	6	TL	-	100	243	
10"	AT 20 X 10 - 10	8.0 AT	7.5 AT ; 8.5 AT	250	514	235	1426	STD	4	TL	-	100	118	
	AT 20 X 10 - 10	8.0 AT	7.5 AT ; 8.5 AT	250	514	235	1526	STD	8	TL	-	80	155	

STD: Standard

Performance



Ø 10"	Tire size	RIM		S.W. (mm)	O.D. (mm)	SLR (mm)	RC (mm)	Version	PR	Type	LI/SS	Load capacity (kg/tire)	
		Rec.	Alt.									km/h - bar	
AT 22 X 8 - 10	6.5 AT	6.0 AT	206	557	-	-	STD	4	TL	-		80	0.35
												109	
AT 22 X 8 - 10	6.5 AT	6.0 AT	206	557	-	-	STD	6	TL	-		100	0.45
												125	
AT 22 X 11 - 10	9.0 AT	8.5 AT	270	564	-	-	STD	4	TL	-		100	0.35
												150	
AT 22 X 11 - 10	9.0 AT	8.5 AT	270	564	-	-	STD	6	TL	-		100	0.45
												175	
AT 23 X 8 - 10	6.5 AT	6.0 AT	210	594	-	-	STD	4	TL	-		100	0.35
												118	
AT 23 X 10 - 10	8.0 AT	7.5 AT ; 8.5 AT	259	594	-	-	STD	4	TL	-		100	0.35
												145	
AT 24 X 11 - 10	9.0	8.5 AT	284	608	-	-	STD	6	TL	-		80	0.45
												200	
AT 24 X 11 - 10	9.0 AT	8.5 AT	284	608	-	-	STD	4	TL	-		100	0.35
												175	
AT 25 X 12 - 10	9.5 AT	9.0 AT ; 10.0 AT	298	630	-	-	STD	4	TL	-		100	0.35
												195	
AT 25 X 12 - 10	9.5 AT	9.0 AT ; 10.0 AT	298	630	-	-	STD	6	TL	-		80	0.45
												224	

STD: Standard

Performance



Ø 11"	Tire size	RIM		S.W. (mm)	O.D. (mm)	SLR (mm)	RC (mm)	Version	PR	Type	LI/SS	Load capacity (kg/tire)		
		Rec.	Alt.									km/h - bar		
AT 22 X 7 - 11	5.5 AT	-	181	557	-	-	STD	4	TL	-		100	0.35	
												97.5		
AT 23 X 8 - 11	6.5 AT	6.0 AT	191	594	-	-	STD	4	TL	-		100	0.35	
												115		
AT 23 X 8 - 11	6.5 AT	6.0 AT	191	594	-	-	STD	6	TL	-		80	0.45	
												132		
AT 24 X 8 - 11	6.5 AT	6.0 AT	206	610	-	-	STD	4	TL	-		100	0.35	
												125		
AT 24 X 9 - 11	7.0 AT	7.5 AT	220	605	-	-	STD	4	TL	-		100	0.35	
												140		
AT 24 X 9 - 11	7.0 AT	7.5 AT	220	605	-	-	STD	6	TL	-		80	0.45	
												165		
AT 24 X 10 - 11	8.0 AT	7.5 AT ; 8.5 AT	254	615	-	-	STD	4	TL	-		100	0.35	
												155		
Ø 12"	AT 25 X 8 - 12	6.5 AT	6.0 AT	212	630	-	-	STD	4	TL	-		100	0.35
													132	
AT 25 X 8 - 12	6.5 AT	6.0 AT	212	630	-	-	STD	6	TL	-		100	0.45	
												155		
AT 25 X 10 - 12	8.0 AT	6.5 AT ; 7.5 AT ; 8.5 AT	254	640	-	-	STD	4	TL	-		100	0.35	
												165		
AT 25 X 10 - 12	8.0 AT	6.5 AT ; 7.5 AT ; 8.5 AT	254	640	-	-	STD	6	TL	-		100	0.45	
												190		

Performance



STD: Standard



Bias



AT 109

AT 109 is an all-terrain tire for ATVs. Its tread design provides excellent field protection.

Ø	Tire size	RIM		S.W. (mm)	O.D. (mm)	SLR (mm)	RC (mm)	Version	PR	Type	LI/SS	Load capacity (kg/tire)		
		Rec.	Alt.									km/h - bar		
6"	AT 145 X 70 - 6	4.5	-	137	366	-	-	STD	2	TL	-	80	0.28	35
7"	AT 16 X 8 - 7	6.5 AT	6.0 AT	183	419	-	-	STD	2	TL	-	80	0.21	52
8"	AT 18 X 9.5 - 8	7.5 AT	8.0 AT	220	468	-	-	STD	2	TL	-	100	0.45	102
8"	AT 20 X 7 - 8	5.5 AT	6.0 AT	170	504	-	-	STD	2	TL	-	100	0.45	100
8"	AT 21 X 9 - 8	7.0 AT	6.5 AT; 7.5 AT	222	536	-	-	STD	2	TL	-	80	0.21	85
8"	AT 22 X 11 - 8	9.0 AT	8.5 AT	230	579	-	-	STD	2	TL	-	100	0.21	112
9"	AT 25 X 12 - 9	9.5 AT	9.0 AT; 10.0 AT	269	617	-	-	STD	2	TL	-	100	0.35	195

STD: Standard

Performance





Bias



AT 110

AT 110 is BKT's tire suitable for all-terrain applications with ATVs. Thanks to its extraordinary steering control, AT 110 is the ideal front axle tire for your vehicle.

Ø	Tire size	RIM		S.W. (mm)	O.D. (mm)	SLR (mm)	RC (mm)	Version	PR	Type	LI/SS	Load capacity (kg/tire)	
		Rec.	Alt.									km/h - bar	
8"	AT 20 X 7 - 8	5.5 AT	6.0 AT	183	508	-	-	STD	4	TL	-	100	88
9"	AT 21 X 8 - 9	6.5 AT	6.0 AT	204	541	-	-	STD	4	TL	-	80	103
10"	AT 21 X 7 - 10	5.5 AT	6.0 AT	178	531	-	-	STD	4	TL	-	100	93
	AT 22 X 8 - 10	6.5 AT	6.0 AT	204	548	-	-	STD	4	TL	-	80	109
	AT 23 X 7 - 10	5.5 AT	6.0 AT	178	584	-	-	STD	4	TL	-	100	109

Performance



Steering Control

STD: Standard





Bias



AT 111

AT 111 is suitable for all-terrain sport racing with ATVs. An "HD" version with a deep tread is available for users who need improved durability and traction.

Ø 8"	Tire size	RIM		S.W. (mm)	O.D. (mm)	SLR (mm)	RC (mm)	Version	PR	Type	LI/SS	Load capacity (kg/tire)		
		Rec.	Alt.									km/h - bar		
AT 18 X 10 - 8	8.0 AT	7.5 AT ; 8.5 AT	254	457	-	-	STD	2	TL	-		80	0.25	
												85		
AT 18 X 10 - 8	8.0 AT	7.5 AT ; 8.5 AT	254	457	-	-	STD	4	TL	-		100	0.35	
												103		
AT 20 X 11 - 8	9.0 AT	8.5 AT	282	508	-	-	STD	6	TL	-		80	0.45	
												155		
AT 22 X 11 - 8	9.0 AT	8.5 AT	282	559	-	-	STD	6	TL	-		100	0.45	
												180		
Ø 9"	AT 18 X 10 - 9	8.0 AT	7.5 AT ; 8.5 AT	254	457	-	-	STD	4	TL	-		100	0.35
													103	
AT 20 X 11 - 9	9.0 AT	8.5 AT	279	508	-	-	STD	4	TL	-		80	0.35	
												132		
AT 20 X 11 - 9	9.0 AT	8.5 AT	279	508	-	-	STD	6	TL	-		100	0.45	
												155		
AT 22 X 11 - 9	9.0 AT	8.5 AT	282	559	-	-	STD	4	TL	-		80	0.35	
												155		
AT 22 X 11 - 9	9.0 AT	8.5 AT	282	559	-	-	STD	6	TL	-		100	0.45	
												180		
Ø 10"	AT 18 X 10 - 10	8.0 AT	7.5 AT ; 8.5 AT	254	457	-	-	STD	4	TL	-		100	0.35
													100	

Performance



STD: Standard



Ø 10"	Tire size	RIM		S.W. (mm)	O.D. (mm)	SLR (mm)	RC (mm)	Version	PR	Type	LI/SS	Load capacity (kg/tire)		
		Rec.	Alt.									km/h - bar		
AT 19 X 6 - 10	5.0	-	152	472	-	-	STD	4	TL	-		80	0.95	100
AT 20 X 6 - 10	5.0	-	152	500	-	-	STD	2	TL	-		80	0.70	90
AT 20 X 6 - 10	5.0	-	152	500	-	-	STD	4	TL	-		100	0.95	105
AT 20 X 11 - 10	9.0 AT	8.5 AT	275	508	-	-	STD	6	TL	-		100	0.45	150
AT 21 X 7 - 10	5.5 AT	6.0 AT	178	541	-	-	STD	4	TL	-		100	0.35	93
AT 21 X 7 - 10	5.5 AT	6.0 AT	178	541	-	-	STD	6	TL	-		100	0.45	106
AT 22 X 7 - 10	5.5 AT	6.0 AT	175	559	-	-	STD	4	TL	-		100	0.35	100
AT 22 X 7 - 10	5.5 AT	6.0 AT	175	559	-	-	STD	6	TL	-		100	0.45	115
AT 22 X 8 - 10	6.5 AT	6.0 AT	208	559	-	-	STD	6	TL	-		100	0.45	125
AT 22 X 11 - 10	9.0 AT	8.5 AT	282	559	-	-	STD	4	TL	-		80	0.35	150
AT 22 X 11 - 10	9.0 AT	8.5 AT	282	559	-	-	STD	6	TL	-		100	0.45	175
AT 23 X 7 - 10	5.5 AT	6.0 AT	178	584	-	-	STD	4	TL	-		100	0.35	109
AT 23 X 7 - 10	5.5 AT	6.0 AT	178	584	-	-	STD	6	TL	-		100	0.45	125



STD: Standard



Bias



AT 111 HD

AT 111 HD is suitable for all-terrain sport racing with ATVs. The increased tread depth and the thick sidewall provide extra grip and braking control in addition to extraordinary traction and high-speed control in power slides. AT 111 HD ensures an extended tire life-cycle.

Ø 9"	Tire size	RIM		S.W. (mm)	O.D. (mm)	SLR (mm)	RC (mm)	Version	PR	Type	LI/SS	Load capacity (kg/tire)	
		Rec.	Alt.									km/h - bar	0.45
	AT 20 X 11 - 9	9.0 AT	8.5 AT	275	515	-	-	STD	6	TL	43 J	100	155
	AT 22 X 11 - 9	9.0 AT	8.5 AT	279	560	-	-	STD	6	TL	-	100	180
Ø 10"	AT 20 X 11 - 10	9.0 AT	8.5 AT	279	505	-	-	STD	6	TL	-	100	150
	AT 21 X 7 - 10	5.5 AT	6.0 AT	178	533	-	-	STD	6	TL	30 J	100	106
	AT 22 X 7 - 10	5.5 AT	6.0 AT	174	560	-	-	STD	6	TL	-	100	115
	AT 22 X 11 - 10	9.0 AT	8.5 AT	279	560	-	-	STD	6	TL	-	100	175
	AT 23 X 7 - 10	5.5 AT	6.0 AT	174	585	-	-	STD	6	TL	-	100	125

STD: Standard

Technologies



Extra Deep Tread

Performance



Durability



Sport



Traction



Bias



AT 112

AT 112 is an all-terrain tire for ATVs. It is particularly suitable for sport performance.

Ø 8"	Tire size	RIM		S.W. (mm)	O.D. (mm)	SLR (mm)	RC (mm)	Version	PR	Type	LI/SS	Load capacity (kg/tire)	
		Rec.	Alt.									km/h - bar	1.50
	AT 20 X 10 - 8	8.0 AT	7.5 AT ; 8.5 AT	240	510	-	-	STD	4	TL	-	80	541

Ø 10"	Tire size	RIM	S.W. (mm)	O.D. (mm)	SLR (mm)	RC (mm)	Version	PR	Type	LI/SS	Load capacity (kg/tire)		
											km/h - bar	1.50	
	AT 20 X 10 - 10	8.0 AT	7.5 AT ; 8.5 AT	240	510	-	-	STD	4	TL	-	100	527

Ø 12"	Tire size	RIM	S.W. (mm)	O.D. (mm)	SLR (mm)	RC (mm)	Version	PR	Type	LI/SS	Load capacity (kg/tire)		
											km/h - bar	1.50	
	AT 23 X 10 - 12	8.0 AT	7.5 AT ; 8.5 AT	240	585	-	-	STD	4	TL	-	80	618

Performance



STD: Standard





Bias



AT 119

AT 119 is suitable for both all-terrain and lawn and garden applications with mowers. Its tread design provides excellent field protection.

Ø 8"	Tire size	RIM		S.W. (mm)	O.D. (mm)	SLR (mm)	RC (mm)	Version	PR	Type	LI/SS	Load capacity (kg/tire)	
		Rec.	Alt.									km/h - bar	
AT 22 X 11 - 8	9.0 AT	8.5 AT	280	580	-	-	STD	2	TL	-		80	125
AT 22 X 11 - 8	9.0 AT	8.5 AT	280	580	-	-	STD	4	TL	-		100	155

Performance



STD: Standard





Bias



AT 171 (R-1 W+)

AT 171 has been specifically designed for mud bogger tractors. The special directional and extra-deep tread design provides excellent traction on wet and muddy surfaces.

Ø 14"	Tire size	RIM		S.W. (mm)	O.D. (mm)	SLR (mm)	RC (mm)	Version	PR	Type	LI/SS	Load capacity (kg/tire)		
		Rec.	Alt.									km/h - bar	1.40	1.00
Ø 14"	AT 28 X 9 - 14	W 7	W 6	205	715	-	-	STD	6	TL	77 A8/ 53 F	40 MUD BOGGING	412	-
												80 MUD BOGGING	206	-
												40 CASUAL TRANSPORT	-	335
												80 CASUAL TRANSPORT	-	170
	AT 30 X 9 - 14	W 7	W 6	211	755	-	-	STD	6	TL	77 A8/ 53 F	40 MUD BOGGING	412	-
												80 MUD BOGGING	206	-
												40 CASUAL TRANSPORT	-	335
												80 CASUAL TRANSPORT	-	170
Ø 16"	AT 31 X 9 - 16	W 7	W 6	211	785	-	-	STD	6	TL	80 A8/ 56 F	40 MUD BOGGING	450	-
												80 MUD BOGGING	224	-
												40 CASUAL TRANSPORT	-	370
												80 CASUAL TRANSPORT	-	190
												km/h - bar	1.40	1.00
Ø 18"	AT 33 X 8 - 18	W 6	W 5.5	200	845	390	2525	STD	6	TL	83 A8/ 59 F	40 MUD BOGGING	487	-
												80 MUD BOGGING	243	-
												40 CASUAL TRANSPORT	-	400
												80 CASUAL TRANSPORT	-	200
	AT 35 X 10 - 18	W 8	-	241	900	417	2646	STD	8	TL	90 A8/ 66 F	40 MUD BOGGING	600	-
												80 MUD BOGGING	300	-
												40 CASUAL TRANSPORT	-	490
												80 CASUAL TRANSPORT	-	245
	AT 35 X 10 - 18	W 8	-	241	900	417	2646	STD	8	TT	90 A8/ 66 F	40 MUD BOGGING	600	-
												80 MUD BOGGING	300	-
												40 CASUAL TRANSPORT	-	490
												80 CASUAL TRANSPORT	-	245
Ø 20"	AT 33 X 9 - 20	W 7	W 6	205	838	387	2616	STD	6	TL	85 A8/ 61 F	40 MUD BOGGING	515	-
												80 MUD BOGGING	257	-
												40 CASUAL TRANSPORT	-	425
												80 CASUAL TRANSPORT	-	218
												km/h - bar	1.40	1.00

Performance



STD: Standard





Ø 20"	Tire size	RIM		S.W. (mm)	O.D. (mm)	SLR (mm)	RC (mm)	Version	PR	Type	LI/SS	Load capacity (kg/tire)		
		Rec.	Alt.											
												km/h - bar	1.40	1.00
AT 35 X 9 - 20	W 7	W 6	200	895	419	2670	STD	6	TL	85 A8/ 61 F	40 MUD BOGGING	515	-	
											80 MUD BOGGING	257	-	
											40 CASUAL TRANSPORT	-	425	
											80 CASUAL TRANSPORT	-	218	
AT 35 X 9 - 20	W 7	W 6	200	895	419	2670	STD	6	TT	85 A8/ 61 F	40 MUD BOGGING	515	-	
											80 MUD BOGGING	257	-	
											40 CASUAL TRANSPORT	-	425	
											80 CASUAL TRANSPORT	-	218	
AT 38 X 10 - 20	W 8	W 7	235	950	442	2835	STD	6	TL	93 A8/ 69 F	40 MUD BOGGING	650	-	
											80 MUD BOGGING	325	-	
											40 CASUAL TRANSPORT	-	530	
											80 CASUAL TRANSPORT	-	265	
AT 38 X 10 - 20	W 8	W 7	235	950	442	2835	STD	6	TT	93 A8/ 69 F	40 MUD BOGGING	650	-	
											80 MUD BOGGING	325	-	
											40 CASUAL TRANSPORT	-	530	
											80 CASUAL TRANSPORT	-	265	
AT 35 X 9 - 22	W 7	W 6	210	890	-	-	STD	6	TL	88 A8/ 64 F	40 MUD BOGGING	560	-	
											80 MUD BOGGING	280	-	
											40 CASUAL TRANSPORT	-	455	
											80 CASUAL TRANSPORT	-	230	
AT 37 X 9 - 22	W 7	W 6	205	945	444	2778	STD	8	TL	88 A8/ 64 F	40 MUD BOGGING	560	-	
											80 MUD BOGGING	280	-	
											40 CASUAL TRANSPORT	-	455	
											80 CASUAL TRANSPORT	-	230	
AT 37 X 9 - 22	W 7	W 6	205	945	444	2778	STD	8	TT	88 A8/ 64 F	40 MUD BOGGING	560	-	
											80 MUD BOGGING	280	-	
											40 CASUAL TRANSPORT	-	455	
											80 CASUAL TRANSPORT	-	230	
AT 40 X 10 - 22	W 8	W 7	235	1005	469	2955	STD	8	TL	95 A8/ 71 F	40 MUD BOGGING	690	-	
											80 MUD BOGGING	345	-	
											40 CASUAL TRANSPORT	-	565	
											80 CASUAL TRANSPORT	-	285	
AT 40 X 10 - 22	W 8	W 7	235	1005	469	2955	STD	8	TT	95 A8/ 71 F	40 MUD BOGGING	690	-	
											80 MUD BOGGING	345	-	
											40 CASUAL TRANSPORT	-	565	
											80 CASUAL TRANSPORT	-	285	

STD: Standard





AT 171 (R-1 W+)

Ø 24"	Tire size	RIM		S.W. (mm)	O.D. (mm)	SLR (mm)	RC (mm)	Version	PR	Type	LI/SS	Load capacity (kg/tire)		
		Rec.	Alt.									km/h - bar	1.40	1.00
	AT 40 X 9 - 24	W 7	W 6	211	995	462	3112	STD	8	TL	90 A8/ 66 F	40 MUD BOGGING	600	-
												80 MUD BOGGING	300	-
												40 CASUAL TRANSPORT	-	485
												80 CASUAL TRANSPORT	-	243

Performance



STD: Standard





Bias



BOGMAX

BOGMAX has been specially designed for all-terrain applications. The very deep tread pattern ensures excellent traction whereas the sidewall protectors reduce impacts and possible damages. BOGMAX is a 6-ply-rated tire with M+S technology - perfect for sport performance in every condition.

Ø 14"	Tire size	RIM		S.W. (mm)	O.D. (mm)	SLR (mm)	RC (mm)	Version	PR	Type	LI/SS	Load capacity (kg/tire)		
		Rec.	Alt.									km/h - bar		
AT 30 X 10 - 14	7.0 AT	7.5 AT ; 8.0 AT	260	760	-	-	STD	6	TL	58 F		80	0.50	236
AT 32 X 10 - 14	8.0 AT	8.5 AT	250	810	-	-	STD	6	TL	62 F		80	0.50	265

STD: Standard

Technologies



Performance





Radial



SIERRA MAX

SIERRA MAX is the BKT tire for both all-terrain and lawn and garden applications. Its radial construction provides a significantly smoother and more comfortable ride over extreme terrains such as deserts, or dirty and rocky surfaces. The special tread design along with its wider footprint provides outstanding forward and lateral traction.

SIERRA MAX
ATV & GO KART TIRES

Ø 12"	Tire size	LI/SS	RIM		S.W. (mm)	O.D. (mm)	SLR (mm)	RC (mm)	SRI (index)	STAR RATING	Version	Type	Load capacity (kg/tire)	
			Rec.	Alt.									km/h - bar	0.50
	AT 25 X 8 R 12	43 N	6.5	-	206	640	292	1899	-	***	STD	TL	140	155
	AT 25 X 10 R 12	50 N	8.0	-	260	640	294	1923	-	***	STD	TL	140	190
Ø 14"	AT 26 X 9 R 14	48 N	7.00	-	230	675	307	2005	-	***	STD	TL	140	180
	AT 26 X 11 R 14	54 N	9.00	-	280	675	310	2007	-	***	STD	TL	140	212
	AT 27 X 9 R 14	50 N	7.00	-	230	700	316	2070	-	***	STD	TL	140	190
	AT 27 X 11 R 14	56 N	9.00	-	280	700	318	2091	-	***	STD	TL	140	224

STD: Standard

Technologies



Performance





Radial



SIERRA MAX PRO

SIERRA MAX PRO is the perfect BKT tire for all-terrain vehicles in ATV applications, also including side-by-side racing. Its radial construction and special wider footprint area provide a smoother ride and an optimized lateral as well as forward traction. Special sturdy lugs have been studied specifically to provide excellent traction and firm grip on the terrain. These features ensure an extraordinarily comfortable ride providing safety and driving control. SIERRA MAX PRO provides excellent performance on every kind of terrain, from hardpack terrains to loose soils.

SIERRAMAX
ATV & GO KART TIRES

Ø 12"	Tire size	LI/SS	RIM		S.W. (mm)	O.D. (mm)	SLR (mm)	RC (mm)	SRI (index)	STAR RATING	Version	Type	Load capacity (kg/tire)	
			Rec.	Alt.									km/h - bar	0.50
	AT 25 X 8 R 12	43 N	6.5	-	200	630	287	1860	-	***	STD	TL	140	155

Ø 14"	Tire size	LI/SS	Rec.	Alt.	S.W. (mm)	O.D. (mm)	SLR (mm)	RC (mm)	SRI (index)	STAR RATING	Version	Type	Load capacity (kg/tire)	
													km/h - bar	1.2
	AT 27 X 11 R 14	56 N	9.00	-	285	708	336	2145	-	***	STD	TL	140	224

STD: Standard

Technologies



Larger Footprint

Performance



Handling and Comfort



Stability



Steering Control



Traction



GO KART





GO KART

Bias



SM 48 (GK)

SM 48 (GK) has been specially designed for go karts. Its smooth tread design provides excellent performance in sport activities. Shore A hardness 48.

Ø 5"	Tire size	RIM		S.W. (mm)	O.D. (mm)	Version	PR	Type	Load capacity (kg/tire)	
		Rec.	Alt.						km/h - bar	
10 X 4.5 - 5	4.5	-	130	260	STD	-	TL	-	4.00	130
11 X 7.10 - 5	6.75	-	190	295	STD	-	TL	-	4.00	135

STD: Standard

Technologies



Performance



GO KART

Bias



SM 54 (GK)

SM 54 (GK) has been specially designed for go karts. Its smooth tread design provides excellent performance in sport activities. Shore A hardness 54.

Ø 5"	Tire size	RIM		S.W. (mm)	O.D. (mm)	Version	PR	Type	Load capacity (kg/tire)	
		Rec.	Alt.						km/h - bar	
10 X 4.5 - 5	4.5	-	130	260	STD	-	TL	-	4.00	130
11 X 7.10 - 5	6.75	-	190	295	STD	-	TL	-	4.00	135

STD: Standard

Technologies



Performance









GO KART

 Bias



SM 68 (GK)

SM 68 has been specially designed for go karts. Its smooth tread design provides excellent performance in sport activities. Shore A hardness 68.

Ø 5"	Tire size	RIM		S.W. (mm)	O.D. (mm)	Version	PR	Type	Load capacity (kg/tire)	
		Rec.	Alt.						km/h - bar	
										
	10 X 4.5 - 5	4.5	-	130	260	STD	-	TL	-	4.00 130
	11 X 6.00 - 5	6.75	-	185	290	STD	-	TL	km/h - bar -	3.86 135
	11 X 7.10 - 5	6.75	-	190	295	STD	-	TL	km/h - bar -	4.00 135

STD: Standard

Technologies



Special Compound

Performance



Sport













Application chart

SOIL TILLAGE





MUNICIPALITY



				
TRACTOR 4WD	TRACTOR 2WD	ROW CROP SPRAYER	RICE & CANE	TRACTOR 4WD
 AGRIMAX V-FLECTO	PRO RIB F2M	 AGRIMAX SPARGO	AGRIMAX ELOS	RIDEMAX IT 696
 AGRIMAX FORCE	TF 8181	AGRIMAX RT 945	TR 270	RIDEMAX IT 697 (M+S)
AGRIMAX FORTIS	TF 9090	AGRIMAX RT 955	TR 273	
AGRIMAX SIRIO	POWER RIB-F2	AGRIMAX RT 855	PUDDLE SPECIAL	
AGRIMAXFACTOR	STEER FARM	TR 318	TR 171	
AGRIMAX RT 657	COMMANDER (F)			
AGRIMAX RT 765	COMMANDER TWIN RIB			
AGRIMAX RT 855	BK 823			
RT 857				
RT 853				
AGRIMAX TURF RT 333				
TR 461				
TR 135				
TR 136				
FARM 2000				
FARM SPECIAL				
AS 2001				
TR 128				
TR 137				
TR 117				
TR 126				
TR 144				
TR 173				
TRAC FARM				
COMMANDER				
TRAC SUPER				
SNOW RIDE				

 Radial Tires
  Bias Tires
  IF IF Technology
  VF Technology

HARVESTING

IMPLEMENT

					
STANDARD HARVESTER		COTTON PICKER		BALER, SEEDER, SPREADER, TRAILER ETC...	
FRONT	REAR	FRONT	REAR		
AGRIMAX TERIS	RM 500	AGRIMAX TERIS	STAR TRAC	TR 882	AS 504
AGRIMAX RT 600	RT 657			TR 360	FARM 2000
 AGRIMAX FORCE	FLOTATION TR 675			FLOTATION 558	INDUSTRIAL RIB F3
TR 137	FLOTATION 648			FLOTATION 648	MULTI RIB F3
TR 135				AW 711	SAND STAR
HARVESTER SPECIAL				AW 702	FAR IMPLEMENT (I-1)
				AW 705	FARM HIGHWAY SPECIAL
				AW 708	FLOTATION RIB 774
				AW 726	SL 441
				AW 909	ST 180
				AW 09	AGRI GRIP
				RIB 774	BK 823
				RIB 775	ST 195
				RIB 900	

 Radial Tires
  Bias Tires
  IF IF Technology
  VF Technology



Application chart

TRANSPORT

 TRAILER, TANK BARREL			 AGRO TRUCK	
FIELD ORIENTED	FIELD & ROAD	ROAD ORIENTED	FRONT	REAR
FL 630 SUPER	 VF-FLEXA	RIDEMAX FL 693 M	MULTIMAX MP 569	FL 634 PERFORMA
FL 630 ULTRA	POWERTRAILER SR 331	RIDEMAX FL 690		FL 633 PERFORMA
FL 639	FL630 SUPER	FL 635		
FLOTATION 351	FL 635	RIDEMAX FL 699		
FLOTATION 558	FL 637			
FLOTATION 648				
FLOTATION 648T				
FLOTATION TR 675				
FLOTATION TR 678				
FL 353				
FL 354				
FL 354				

 Radial Tires
  Bias Tires
  IF IF Technology
  VF Technology

FORESTRY

 TRACTOR, FORWARDER, HARVESTER	 TRAILER	 LAWN & GARDEN, ATV, GOLF
FS 216	FLOTATION 648	AGRIMAX TURF RT 333
TR 675	TR882	TR 360
TR 678		LG SMOOTH
FORESTMAX		LG 306
FORESTLAND		LG 307
FORESTECH		LG 408
F 240		LG RIB
TR135		TRAC MASTER
		TR 313
		TR 315
		TR 317
		TR 319
		GF 304
		GF 305 CLASSIC
		SNOW-RIDE

 Radial Tires
  Bias Tires
  IF IF Technology
  VF Technology

MAINTENANCE / HANDLING & MOBILITY



Size equivalence vs SRI

SRI (SPEED RADIUS INDEX)

SRI	Size	SRI	Size	
330	200/70 R 16	550	210/95 R 28 (9.5 - 28)	
340	220/70 R 16		250/85 R 28 (9.5 - 28)	
350	240/70 R 16* (6.0 - 16)		320/85 R 24 (12.4 - 24)	
360	180/95 R 16 (6.5 - 16)		340/80 R 24* (12.4 - 24)	
370	260/70 R 16		360/70 R 24 (12.4 - 24)	
390	210/95 R 16 (7.5 - 16)	575	420/65 R 24 (12.4 - 24)	
	250/80 R 16 (7.5 - 16)		280/85 R 28 (11.2 - 28)	
	250/80 R 16 (7.5 - 16)		340/85 R 24 (13.6 - 24)	
	280/70 R 16 (7.5 - 16)		380/70 R 24 (13.6 - 24)	
320/65 R 16 (7.5 - 16)	400/80 R 24* (13.6 - 24)			
410	210/95 R 18 (7.5 - 18)	575	440/65 R 24 (13.6 - 24)	
	250/80 R 18 (7.5 - 18)		210/95 R 32 (9.5 - 32)	
	250/80 R 18 (7.5 - 18)		230/95 R 32 (9.5 - 32)	
	280/70 R 18 (7.5 - 18)		320/85 R 28 (12.4 - 28)	
320/65 R 18 (7.5 - 18)	360/70 R 28 (12.4 - 28)			
425	210/90 R 20 (7.5 - 20)		625	360/80 R 24* (14.9 - 24)
	260/70 R 20 (7.5 - 20)			380/85 R 24 (14.9 - 24)
450	340/65 R 18			420/65 R 28 (12.4 - 28)
	210/95 R 20 (9.5 - 20)			420/70 R 24 (14.9 - 24)
	250/85 R 20 (9.5 - 20)			460/70 R 24* (14.9 - 24)
	280/70 R 20 (9.5 - 20)	460/65 R 24* (14.9 - 24)		
475	300/70 R 20	480/65 R 24 (14.9 - 24)		
	340/65 R 20 (9.5 - 20)	340/85 R 28 (13.6 - 28)		
	210/90 R 24 (8.3 - 24)	380/70 R 28 (13.6 - 28)		
	280/85 R 20 (11.2 - 20)	420/85 R 24 (16.9 - 24)		
500	320/70 R 20 (11.2 - 20)	440/65 R 24 (16.9 - 24)		
	340/80 R 18*	440/65 R 28 (13.6 - 28)		
	250/85 R 24 (9.5 - 24)	480/60 R 28 (13.6 - 28) (VF) (NRO)		
	320/85 R 20 (12.4 - 20)	480/70 R 24 (16.9 - 24)		
525	360/70 R 20 (12.4 - 20)	500/70 R 24*		
	420/65 R 20 (12.4 - 20)	540/65 R 24 (16.9 - 24)		
	280/85 R 24 (11.2 - 24)			
	300/80 R 24 (11.2 - 24)			
	320/70 R 24 (11.2 - 24)			
	380/70 R 20			
	440/65 R 20			

IF/VF TECHNOLOGY

*Available as Agri or Industrial Municipality tire
 IF (Increased Flexion); VF (Very High Flexion); NRO (Narrow Rim Option); CFO (Cyclic Field Operation);
 CHO (Cyclic Harvesting Operation).

SRI (SPEED RADIUS INDEX)

SRI	Size	SRI	Size
650	230/95 R 36 (9.5 - 36)	725	230/95 R 42
	270/95 R 32 (12.4 - 32)		320/85 R 38 (12.4 - 38)
	320/85 R 32 (12.4 - 32)		340/85 R 36 (13.6 - 36)
	380/85 R 28 (14.9 - 28)		380/85 R 34
	400/80 R 28* (14.9 - 28)		420/90 R 30 (18.4 - 30)
	420/70 R 28 (14.9 - 28)		460/85 R 30 (18.4 - 30)
	420/85 R 26 (16.9 - 26)		480/80 R 30* (18.4 - 30)
	480/65 R 28* (14.9 - 28)		600/70 R 28 (IF)
	520/60 R 28 (14.9 - 28) (VF) (NRO)		600/65 R 30 (18.4 - 30)
675	270/95 R 36	750	710/55 R 30 (18.4 - 30) (IF) (CFO)
	320/85 R 34		210/95 R 44
	320/90 R 32		340/85 R 38 (13.6 - 38)
	380/85 R 30 (14.9 - 30)		380/80 R 38 (13.6 - 38) (IF)
	420/70 R 30 (14.9 - 30)		420/85 R 34 (16.9 - 34)
	420/85 R 28 (16.9 - 28)		440/80 R 34* (16.9 - 34)
	440/80 R 28* (16.9 - 28)		480/70 R 34 (16.9 - 34) (R-2)
	460/85 R 26 (18.4 - 26)		540/65 R 34 (16.9 - 34)
	480/70 R 28 (16.9 - 28)		600/70 R 30* (VF) (IF) (CFO) (NRO)
	540/65 R 28* (16.9 - 28) (VF) (NRO)		620/75 R 26 (23.1 - 26) (CHO)
600/60 R 28 (16.9 - 28) (VF) (NRO)	775	230/95 R 44	
270/95 R 40		300/85 R 42	
270/95 R 38 (11.2 - 38)		380/85 R 38 (VF) (R-2)	
320/85 R 36 (12.4 - 36)		460/85 R 34 (18.4 - 34)	
420/85 R 30 (16.9 - 30)		480/80 R 34* (18.4 - 34)	
440/80 R 30* (16.9 - 30)		520/70 R 34 (18.4 - 34)	
480/70 R 30 (16.9 - 30)		600/65 R 34 (18.4 - 34) (NRO)	
540/65 R 30* (16.9 - 30) (VF) (NRO)		650/60 R 34 (18.4 - 34) (IF)	
600/60 R 30 (16.9 - 30) (VF) (NRO)		710/55 R 34 (18.4 - 34) (IF) (CFO)	
600/65 R 28* (18.4 - 28) (NRO)		710/60 R 30 (IF) (CFO)	
710/55 R 28 (18.4 - 28) (IF) (CFO) (CHO)	750/65 R 26 (28L - L26)		

IF/VF TECHNOLOGY

*Available as Agri or Industrial Municipality tire
 IF (Increased Flexion); VF (Very High Flexion); NRO (Narrow Rim Option); CFO (Cyclic Field Operation);
 CHO (Cyclic Harvesting Operation).



Size equivalence vs SRI

Size equivalence

SRI (SPEED RADIUS INDEX)

SRI	Size	SRI	Size
800	270/95 R 44	925	270/95 R 54
	320/90 R 42		300/95 R 52
	420/85 R 38 (16.9 - 38) (IF)		480/80 R 46 (VF)
	480/70 R 38 (16.9 - 38)		520/85 R 42 (CFO) (R-2)
	540/65 R 38 (16.9 - 38) (VF) (NRO)		540/80 R 42*
	600/60 R 38 (16.9 - 38) (VF) (NRO)		620/70 R 42
	600/70 R 34 (IF)		650/65 R 42* (VF) (NRO)
	620/75 R 30 (23.1 - 30) (IF) (CFO) (CHO)		650/75 R 38 (IF) (CFO)
825	230/95 R 48	950	710/60 R 42 (VF) (NRO)
	270/95 R 46		710/70 R 38* (VF) (R-2)
	460/85 R 38 (18.4 - 38)		900/55 R 38
	480/80 R 38* (18.4 - 38) (R-2)		320/90 R 54
	520/70 R 38 (18.4 - 38)		380/90 R 50 (VF)
	600/65 R 38* (18.4 - 38)		710/75 R 38 (VF) (CFO)
	650/60 R 38 (18.4 - 38) (VF) (NRO)		900/50 R 42 (IF) (CFO)
	650/65 R 34 (20.8 - 34) (VF) (CFO)		480/80 R 50 (VF)
	710/55 R 38 (18.4 - 38) (VF)		520/85 R 46 (R-2)
	710/60 R 34 (20.8 - 34) (VF) (IF) (CFO) (NRO)		580/85 R 42 (VF) (CFO)
850	300/95 R 46	975	620/70 R 46
	320/90 R 46		650/75 R 42
	340/85 R 46		650/85 R 38 (IF) (CFO)
	650/75 R 32 (24.5 - 32) (CHO)		710/70 R 42 (VF) (IF) (CFO)
			800/70 R 38 (VF) (CFO)
875	340/85 R 48	1000	900/60 R 38 (IF) (CFO)
	480/80 R 42 (R-2)		1250/50 R 32 (IF) (CFO)
	520/85 R 38 (20.8 - 38)		380/90 R 54
	540/80 R 38* (20.8 - 38)		380/105 R 50 (VF)
	580/70 R 38 (20.8 - 38)		420/95 R 50 (VF)
	620/70 R 38 (20.8 - 38)		710/75 R 42 (IF) (CFO)
	650/65 R 38* (20.8 - 38) (VF) (IF) (CFO) (NRO)		520/85 R 50
	710/60 R 38 (20.8 - 38) (VF) (IF) (NRO)		650/85 R 42 (IF) (CFO)
	800/65 R 32 (CHO)		750/70 R 44 (VF)
	1050/50 R 32 (CHO)		800/70 R 42 (IF) (CFO)
900	320/90 R 50 (VF)	1025	900/60 R 42 (VF) (IF) (CFO) (NRO)
	380/90 R 46 (VF)		1050
	420/80 R 46		1075
	710/75 R 34 (IF)		480/95 R 50 (IF)
	900/60 R 32 (CHO)		750/75 R 46 (IF) (CFO)

IF/VF TECHNOLOGY

*Available as Agri or Industrial Municipality tire
 IF (Increased Flexion); VF (Very High Flexion); NRO (Narrow Rim Option); CFO (Cyclic Field Operation);
 CHO (Cyclic Harvesting Operation).

RIM DIAMETER

RIM DIAMETER	Size	SRI	RIM DIAMETER	Size	SRI
Ø 16"	180/95 R 16 (6.5 - 16)	360	Ø 24"	210/90 R 24 (8.3 - 24)	475
	200/70 R 16	330		250/85 R 24 (9.5 - 24)	500
	210/95 R 16 (7.5 - 16)	390		280/85 R 24 (11.2 - 24)	525
	220/70 R 16	340		300/80 R 24* (11.2 - 24)	525
	240/70 R 16* (6.0 - 16)	350		320/70 R 24 (11.2 - 24)	525
	250/80 R 16 (7.5 - 16)	390		320/85 R 24 (12.4 - 24)	550
	250/80 - 16 (7.5 - 16)	390		340/80 R 24* (12.4 - 24)	550
	260/70 R 16	370		340/85 R 24 (13.6 - 24)	575
	280/70 R 16 (7.5 - 16)	390		360/70 R 24 (12.4 - 24)	550
	320/65 R 16 (7.5 - 16)	390		360/80 R 24* (14.9 - 24)	600
	320/65 R 16 (8.25 - 16)	400		380/70 R 24 (13.6 - 24)	575
				380/85 R 24 (14.9 - 24)	600
				400/80 R 24* (13.6 - 24)	575
				420/65 R 24 (12.4 - 24)	550
Ø 18"	210/95 R 18 (7.5 - 18)	410	Ø 26"	420/70 R 24 (14.9 - 24)	600
	250/80 R 18 (7.5 - 18)	410		420/85 R 24 (16.9 - 24)	625
	250/80 - 18 (7.5 - 18)	410		440/65 R 24 (13.6 - 24)	575
	280/70 R 18 (7.5 - 18)	410		440/65 R 24* (16.9 - 24)	625
	320/65 R 18 (7.5 - 18)	410		460/65 R 24* (14.9 - 24)	600
	340/65 R 18	425		460/70 R 24* (14.9 - 24)	600
	340/80 R 18*	475		480/65 R 24 (14.9 - 24)	600
				480/70 R 24 (16.9 - 24)	625
				500/70 R 24*	625
				540/65 R 24 (16.9 - 24)	625
Ø 20"	210/90 R 20 (7.5 - 20)	425	Ø 28"	420/85 R 26 (16.9 - 26)	650
	210/95 R 20 (9.5 - 20)	450		460/85 R 26 (18.4 - 26)	675
	250/85 R 20 (9.5 - 20)	450		620/75 R 26 (23.1 - 26) (CHO)	750
	260/70 R 20 (7.5 - 20)	425		750/65 R 26 (28L - L26) (CHO)	775
	280/70 R 20 (9.5 - 20)	450			
	280/85 R 20 (11.2 - 20)	475			
	300/70 R 20	450			
	320/70 R 20 (11.2 - 20)	475			
	320/85 R 20 (12.4 - 20)	500			
	340/65 R 20 (9.5 - 20)	450			
360/70 R 20 (12.4 - 20)	500				
380/70 R 20	525				
420/65 R 20 (12.4 - 20)	500				
440/65 R 20	525				

IF/VF TECHNOLOGY

*Available as Agri or Industrial Municipality tire
 IF (Increased Flexion); VF (Very High Flexion); NRO (Narrow Rim Option); CFO (Cyclic Field Operation);
 CHO (Cyclic Harvesting Operation).



Size equivalence vs SRI

RIM DIAMETER

RIM DIAMETER	Size	SRI	RIM DIAMETER	Size	SRI
Ø 28"	210/95 R 28 (9.5 - 28)	550	Ø 30"	710/55 R 30 (18.4 - 30) (IF) (CFO)	725
	250/85 R 28 (9.5 - 28)	550		710/60 R 30 (IF) (CFO)	775
	280/85 R 28 (11.2 - 28)	575	Ø 32"	210/95 R 32 (9.5 - 32)	600
	320/85 R 28 (12.4 - 28)	600		230/95 R 32 (9.5 - 32)	600
	340/85 R 28 (13.6 - 28)	625		270/95 R 32 (12.4 - 32)	650
	360/70 R 28 (12.4 - 28)	390		320/85 R 32 (12.4 - 32)	650
	380/70 R 28 (13.6 - 28)	625		320/90 R 32	675
	380/85 R 28 (14.9 - 28)	650		650/75 R 32 (24.5 - 32) (CHO)	850
	400/80 R 28* (14.9 - 28)	650		800/65 R 32 (CHO)	875
	420/65 R 28 (12.4 - 28)	600		900/60 R 32 (CHO)	900
	420/70 R 28 (14.9 - 28)	650		1050/50 R 32 (CHO)	875
	420/85 R 28 (16.9 - 28) (R-2)	675		1250/50 R 32 (IF) (CFO)	975
	440/65 R 28 (13.6 - 28)	625	Ø 34"	320/85 R 34	675
	440/80 R 28* (16.9 - 28)	675		380/85 R 34	725
	480/60 R 28 (13.6 - 28) (VF) (NRO)	625		420/85 R 34 (16.9 - 34)	750
	480/65 R 28* (14.9 - 28)	650		440/80 R 34* (16.9 - 34)	750
	480/70 R 28 (16.9 - 28)	675		460/85 R 34 (18.4 - 34)	775
	520/60 R 28 (14.9 - 28) (VF) (NRO)	650		480/70 R 34 (16.9 - 34) (R-2)	750
	540/65 R 28* (16.9 - 28) (VF) (NRO)	675		480/80 R 34* (18.4 - 34)	775
	600/60 R 28 (16.9 - 28) (VF) (NRO)	675		520/70 R 34 (18.4 - 34)	775
600/65 R 28* (18.4 - 28) (VF) (NRO)	700	540/65 R 34 (16.9 - 34)		750	
600/70 R 28 (IF)	725	600/65 R 34 (18.4 - 34) (NRO) (VF)		775	
710/55 R 28 (18.4 - 28) (IF) (CFO) (CHO)	700	600/70 R 34 (IF)	800		
Ø 30"	380/85 R 30 (14.9 - 30)	675	650/60 R 34 (18.4 - 34) (VF) (IF)	775	
	420/70 R 30 (14.9 - 30)	675	650/65 R 34 (20.8 - 34) (IF) (CFO)	825	
	420/85 R 30 (16.9 - 30)	700	710/55 R 34 (18.4 - 34) (IF) (CFO)	775	
	420/90 R 30 (18.4 - 30)	725	710/60 R 34 (20.8 - 34) (VF) (IF) (NRO) (CFO)	825	
	440/80 R 30* (16.9 - 30)	700	710/75 R 34 (IF) (CFO)	900	
	460/85 R 30 (18.4 - 30)	725	Ø 36"	230/95 R 36 (9.5 - 36)	650
	480/70 R 30 (16.9 - 30)	700		270/95 R 36	675
	480/80 R 30* (18.4 - 30)	725		320/85 R 36 (12.4 - 36)	700
	540/65 R 30* (16.9 - 30) (VF) (NRO)	700		340/85 R 36 (13.6 - 36)	725
	600/60 R 30 (16.9 - 30) (VF) (NRO)	700			
600/65 R 30 (18.4 - 30)	725				
600/70 R 30* (VF) (IF) (CFO) (NRO)	750				
620/75 R 30 (23.1 - 30) (IF) (CFO) (CHO)	800				

IF/VF TECHNOLOGY

*Available as Agri or Industrial Municipality tire
 IF (Increased Flexion); VF (Very High Flexion); NRO (Narrow Rim Option); CFO (Cyclic Field Operation);
 CHO (Cyclic Harvesting Operation).

RIM DIAMETER

RIM DIAMETER	Size	SRI	RIM DIAMETER	Size	SRI
Ø 38"	270/95 R 38 (11.2 - 38)	700	Ø 42"	620/70 R 42	925
	320/85 R 38 (12.4 - 38)	725		650/65 R 42* (VF) (NRO)	925
	340/85 R 38 (13.6 - 38) (R-2)	750		650/75 R 42	975
	380/80 R 38 (13.6 - 38) (IF)	750		650/85 R 42 (IF) (CFO)	1025
	380/85 R 38 (VF) (R-2)	775		710/60 R 42 (VF) (NRO)	925
	420/85 R 38 (16.9 - 38) (IF) (R-2)	800		710/70 R 42* (VF) (IF) (CFO)	975
	460/85 R 38 (18.4 - 38)	825		710/75 R 42 (IF) (CFO)	1000
	480/70 R 38 (16.9 - 38)	800		800/70 R 42 (IF) (CFO)	1025
	480/80 R 38* (18.4 - 38) (R-2)	825		900/50 R 42 (IF) (CFO)	950
	520/70 R 38 (18.4 - 38)	825		900/60 R 42 (VF) (IF) (NRO) (CFO)	1025
	520/85 R 38 (20.8 - 38)	875	210/95 R 44	750	
	540/65 R 38 (16.9 - 38) (VF) (NRO)	800	230/95 R 44	775	
	540/80 R 38* (20.8 - 38)	875	270/95 R 44	800	
	580/70 R 38 (20.8 - 38)	875	750/70 R 44 (VF)	1025	
	600/60 R 38 (16.9 - 38) (VF) (NRO)	800	Ø 46"	270/95 R 46	825
600/65 R 38* (18.4 - 38)	825	300/95 R 46		850	
620/70 R 38 (20.8 - 38)	875	320/90 R 46		850	
650/60 R 38 (18.4 - 38) (VF) (NRO)	825	340/85 R 46		850	
650/65 R 38* (20.8 - 38) (IF) (CFO) (NRO)	875	380/90 R 46 (VF)		900	
650/75 R 38 (IF) (CFO)	925	420/80 R 46		900	
650/85 R 38* (IF) (CFO)	975	480/80 R 46 (VF)		925	
710/55 R 38 (18.4 - 38) (VF) (NRO)	825	520/85 R 46 (R-2)		975	
710/60 R 38 (20.8 - 38) (VF) (IF) (NRO)	875	620/70 R 46		975	
710/70 R 38* (VF) (R-2)	925	750/75 R 46 (IF) (CFO)		1100	
710/75 R 38 (VF)	950	Ø 48"	230/95 R 48	825	
800/70 R 38 (VF) (IF) (CFO)	975		340/85 R 48	875	
900/55 R 38	925		320/90 R 50 (VF)	900	
900/60 R 38 (IF) (CFO)	975		380/90 R 50 (VF)	950	
Ø 40"	230/95 R 40	700	Ø 46"	380/105 R 50 (VF)	1000
	230/95 R 42	725		420/95 R 50 (VF)	1000
	300/85 R 42	775		480/80 R 50 (VF)	975
	320/90 R 42	800		480/95 R 50 (IF)	1050
	480/80 R 42 (R-2)	875		520/85 R 50	1025
Ø 42"	520/85 R 42 (R-2)	925	Ø 52"	300/95 R 52	925
	540/80 R 42*	925		270/95 R 54	925
	580/85 R 42 (VF) (CFO)	975	Ø 54"	320/90 R 54	950
				380/90 R 54	1000

IF/VF TECHNOLOGY

*Available as Agri or Industrial Municipality tire
 IF (Increased Flexion); VF (Very High Flexion); NRO (Narrow Rim Option); CFO (Cyclic Field Operation);
 CHO (Cyclic Harvesting Operation).



Load index

Load Index & Speed Symbol

LI	lbs	LI	lbs	LI	lbs	LI	lbs
50	420	85	1135	120	3085	155	8540
51	430	86	1170	121	3195	156	8820
52	440	87	1200	122	3305	157	9095
53	455	88	1235	123	3415	158	9370
54	465	89	1280	124	3525	159	9645
55	480	90	1325	125	3635	160	9920
56	495	91	1355	126	3750	161	10195
57	505	92	1390	127	3860	162	10470
58	520	93	1435	128	3970	163	10745
59	535	94	1475	129	4080	164	11025
60	550	95	1520	130	4190	165	11355
61	565	96	1565	131	4300	166	11685
62	585	97	1610	132	4410	167	12015
63	600	98	1655	133	4540	168	12345
64	615	99	1710	134	4675	169	12785
65	640	100	1765	135	4805	170	13225
66	660	101	1820	136	4940	171	13560
67	675	102	1875	137	5070	172	13890
68	695	103	1930	138	5205	173	14330
69	715	104	1985	139	5355	174	14770
70	740	105	2040	140	5510	175	15210
71	760	106	2095	141	5675	176	15650
72	785	107	2150	142	5840	177	16095
73	805	108	2205	143	6005	178	16535
74	825	109	2270	144	6175	179	17085
75	855	110	2335	145	6395	180	17635
76	880	111	2405	146	6615	181	18185
77	910	112	2470	147	6780	182	18740
78	935	113	2535	148	6945	183	19290
79	965	114	2600	149	7165	184	19840
80	990	115	2680	150	7385	185	20390
81	1020	116	2755	151	7605	186	20945
82	1045	117	2835	152	7825	187	21495
83	1075	118	2910	153	8045	188	22045
84	1100	119	3000	154	8265	189	22705

LI	lbs	LI	lbs	LI	lbs
190	23370	200	30865	210	41885
191	24030	201	31965	211	42990
192	24690	202	33070	212	44090
193	25350	203	34170	213	45415
194	26015	204	35270	214	46735
195	26785	205	36375	215	48060
196	27555	206	37475	216	49380
197	28330	207	38580	217	50705
198	29100	208	39680	218	52025
199	29980	209	40785	219	53570

SPEED SYMBOL

Speed symbol	A2	A4	A6	A8	B	C	D	E	F	G	J	K
mph	5	10	20	25	30	35	40	45	50	55	62	68



Highlights

VF TECHNOLOGY

Reduced soil compaction



Over the last decades, a progressive compaction of farming soil occurred. The loss due to this phenomenon is esteemed to reach about 20% of the total harvest. Limiting soil compaction is an urgent practice for maximizing the yield per hectare preserving both the land's integrity and peculiarities. The new AGRIMAX V-FLECTO shows an optimized footprint and a 10% larger tread profile compared to a standard tire of the same size. This leads to a remarkable decrease in soil compaction resulting in major overall efficiency in terms of both farming operations and business profits.

AGRIMAX V-FLECTO requires a lower inflation pressure compared to a standard tire or an IF technology tire with loads being equal.

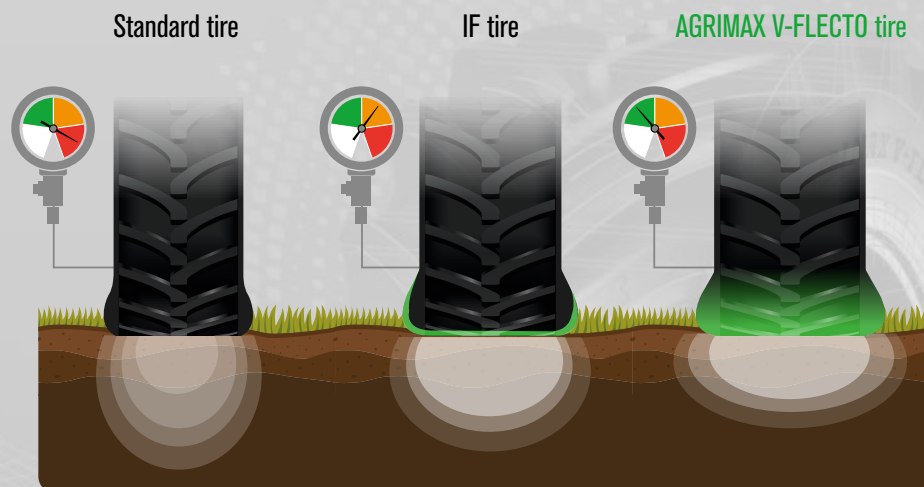

Less operating costs

Specifically conceived for a long product life-cycle and an optimum return on investment, AGRIMAX V-FLECTO has been built for an at least 10% longer tire life compared to an equivalent standard tire. Even if operating at low pressure, this new BKT tire stands for power and strength as well as excellent resistance over the time, without compromising performance - yet, ensuring less overall costs for tire management.



Standard tire

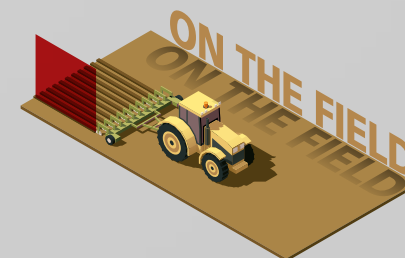

Same operating time

AGRIMAX V-FLECTO tire



Major performance



Less cost

Without any doubt, time is a main - sometimes hidden - determinant in a farming business as far as overall operating costs are concerned. AGRIMAX V-FLECTO has been designed for the purpose of optimizing operating hours and supporting farmers' profitability, saving them time and money. Thanks to its distinct tread design, the new AGRIMAX V-FLECTO tire also increases efficiency on the road by reducing transport cycles. It offers excellent traction, optimizing operations in the fields and increasing yields per hectare. In addition, AGRIMAX V-FLECTO ensures tangible time savings due to reduced standstill periods, since it is not necessary to change inflation pressures when alternating between field operations and road travel.



Highlights

VF TECHNOLOGY

Higher load capacity



Presently, there is a trend - and this will remain valid in the future - towards always heavier machinery carrying always heavier loads. Unfortunately, this results in an increased risk of soil compaction and crop damages. Against this complex backdrop, the role of the tire becomes fundamental, since it has to sustain considerable weights. AGRIMAX V-FLECTO has been developed right for the purpose of satisfying today and tomorrow's needs. It is the perfect response to the requirement of maximizing load capacity without changing inflation pressure regardless of the speed. While ordinary VF tires carry 40% heavier loads compared to a standard tire of the same size on a wider rim, a NRO marked VF tire is also able to sustain 40% more weight compared to a standard tire of the same size but on the same rim. With AGRIMAX V-FLECTO fitted on your farming equipment, it is hence unnecessary to use a wider rim (referring to the standard rim as to specifications) when carrying up to 40% heavier loads.

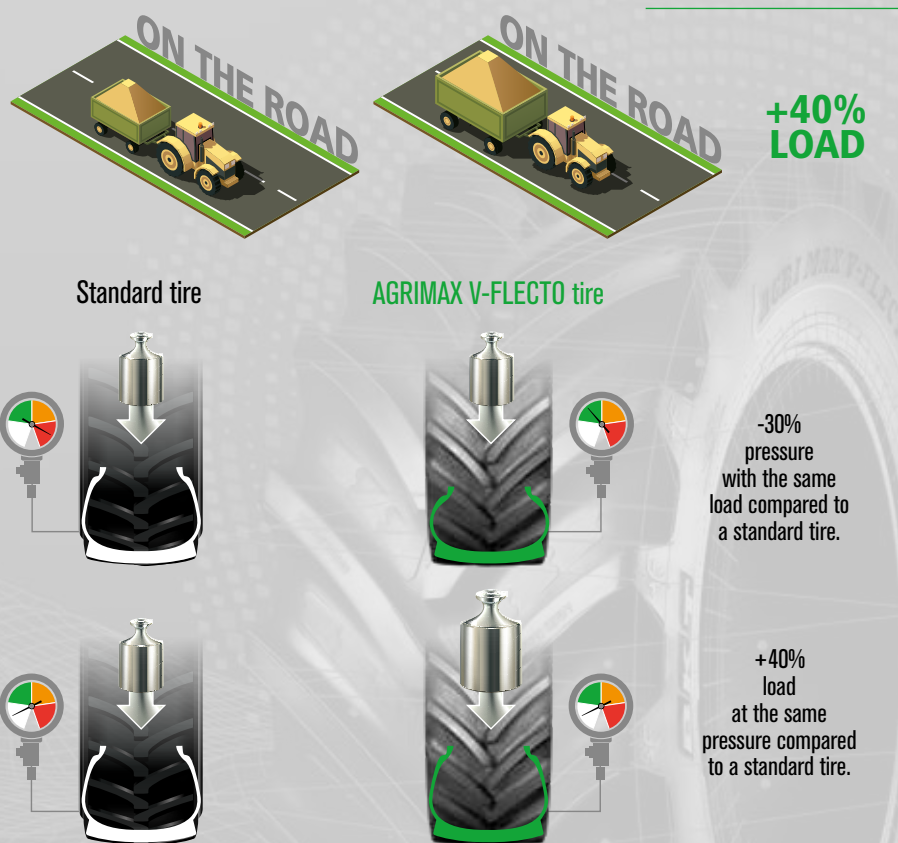

Narrow Rim Option NRO Technology

Tires designed with VF technology usually require a larger rim to be flitted on, compared to the one needed for a standard tire. Using BKT's brand-new AGRIMAX V-FLECTO, instead, there is no need for purchasing specific rims. BKT, indeed, proves to be able to cope with first-class technologies to best serve final users, since it has already adopted Narrow Rim Option, an innovative solution, according to the recently introduced experimental standard by the European Tire and Rim Technical Organization (E.T.R.T.O.). In order to know which BKT product has the "NRO" mark and before carrying out any fitting operations, it is recommended to carefully read the technical product information available on the website www.bkt-tires.com and to rely only on experienced staff or tire experts for any mounting and dismounting operations.

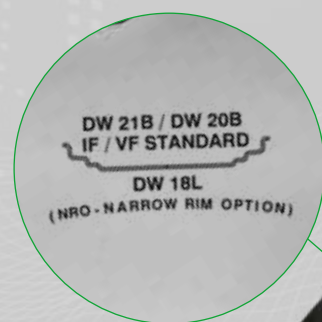



Highlights

VF TECHNOLOGY

Maximum performance

AGRIMAX V-FLECTO has been developed and engineered with an extremely strong and robust structure perfectly resisting against all kinds of stress even under the most demanding operating conditions. The elevated fatigue strength makes the new AGRIMAX V-FLECTO tire the perfect solution to cater for the needs of a modern farming business, suitable for being employed in the fields as well as during road transfers.

The specific Bead Protection System featuring a special reinforced bead enables an even more air-tight fitting on the rim in order to ensure best adherence and constant pressure values under any operating condition. Safe driving and effortless steering in addition to stability are the challenges, indeed, that the BKT Research & Development Center faces every day for the purpose of engineering state-of-the-art tires that are highly reliable.

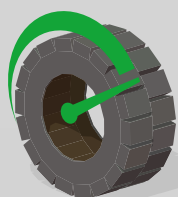

Extremely strong & robust structure for major resistance against fatigue

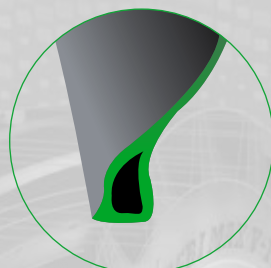

Bead Protection System for a more air-tight fitting on the rim



Reliable comfort

As a consequence of increased average dimensions of farming businesses and the land to be tilled as well as longer and more frequent travel, driving comfort is becoming a more and more essential element for today's farmers. In order to reduce operator's fatigue and to ensure an enjoyable ride, BKT has designed the new AGRIMAX V-FLECTO tire with optimized geometrical features, in particular, using new lug angles. The result is enhanced driving comfort both in the fields and on the road due to notably reduced vibrations and a lower noise level.

In addition, the special polyester casing enables the tire to rapidly regain its correct shape even after longer standstills contributing by this way to a more enjoyable ride.

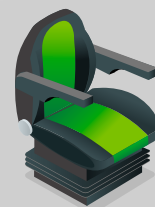

Less vibration



Less noise





Tire markings

READING YOUR TIRE

This section is intended for operators from the agricultural, industrial or earthmoving sectors. It contains useful information about specific Off-Highway tire features as well as some recommendations for maintenance and storage.

The main information about your tire can be found right on the tire. You just need to know how to read it.



- 1. Tire range name
- 2. Pattern name
- 3. Direction of rotation
- 4. Tube type / Tubeless
- 5. Load & Speed index, load, speed, pressure details
- 6. Brand name
- 7. Prefix

- 8. Tire size
- 9. Suffix
- 10. Production date identification code (week / year)
- 11. Max inflation pressure by tire mounting operation
- 12. Safety symbol

These are the main parameters for measuring a tire:

OD - OVERALL DIAMETER

This parameter is measured after the tire being properly mounted on the reference rim and inflated at the pressure recommended by the manufacturer for at least 24 hours without any load.

LOAD INDEX

The load index is a numeric code that defines the tire's maximum loading capacity in kg. For each tire type/size, the loading capacity is always related to a specific inflation pressure as defined by ETRTO standards and manufacturer specifications.

SW - SECTION WIDTH

This parameter indicates the outer sidewall distance without taking into consideration the prominences due to tire code marking. The section width is measured after the tire being properly mounted on the reference rim and inflated at the pressure recommended by the manufacturer for at least 24 hours without any load.

SPEED CODE

The speed code is a symbol that indicates the maximum speed admitted at the given load index, following any other specific conditions defined by the tire manufacturer.

OW - OVERALL WIDTH

This parameter indicates a tire's section width at its largest point including all prominences such as tire code marking, sidewall lettering, tire brand, etc. The overall width is measured after the tire being properly mounted on the reference rim and inflated at the pressure recommended by the manufacturer for at least 24 hours without any load.

SH - SECTION HEIGHT

This parameter indicates the vertical section of the tire. It is calculated based on the overall diameter less the rim diameter divided by two.

SLR - STATIC LOADED RADIUS

This parameter indicates the vertical distance between the ground and the tire rotation axis. It is measured with the tire inflated at its nominal pressure, properly mounted on its reference rim at maximum load according to the values defined in the load index.

SLW - STATIC LOADED WIDTH

This parameter indicates the outer distance between the tire sidewalls. It is measured with the tire inflated at its nominal pressure, properly mounted on its reference rim at maximum load according to the values defined in the load index.

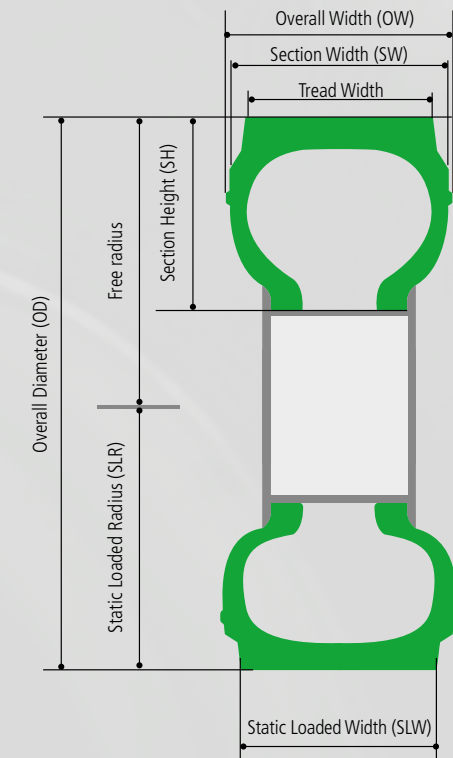



Mounting & dismounting



MOUNTING & DISMOUNTING

Please be aware that both mounting and dismounting OFF-Highway tires are hazardous operations. These must be performed by expert and qualified staff members only, using appropriate tools and procedures, as illustrated by the vehicle and machinery manufacturer.

Pressurized air used to inflate tires must always be controlled by means of an air pressure gauge.

Any non-compliance with the correct procedures may result in incorrect fitting of the tire on the rim and on the vehicle. This is a serious risk for the operator's safety.

DISCLAIMER OF LIABILITY:

BKT does not undertake any responsibility in relation to the exactness or correctness of information or illustrations contained in this section. BKT declines any direct or indirect liability for any material damage or personal injury which might arise directly or incidentally from the use of any information contained in this section. For any question in relation to specific operating issues always refer to the manufacturer of your vehicle or equipment.



Mounting & dismounting

MOUNTING PREPARATION

Before fitting the tire on the rim, make sure that the following mandatory aspects and requirements are met:

Tire size and features must be suitable for the vehicle and the application to be used.

The rim size to be used must be approved and contained in the BKT Technical Databook prepared following ETRTO Standard Manual; it must be suitable for the tire size.

Mounting and dismounting operations shall be performed by qualified and adequately trained technical staff or professionals only.

Always refer to the instructions and procedures indicated by the rim, tire, and vehicle manufacturers. (Fig_01)

Use appropriate tools and equipment in good condition only. Using a wrong rim can limit the tire performance and cause its damage.



FIG_01

Check the rim beforehand; use a metal brush to properly clean the entire surface and check its state. Never use rims with weld joints nor rims that are visibly deformed or damaged. (Fig_02)

The tire bead must be clean and without any elements or damages that might cause an air leak. (Fig_03)

In case of mounting a tire that has already been used, accurately check both the tire's inside and outside for possible damages to be repaired. Do not mount tires with clear signs of strain.

Use a compressor to clean and dry the inner part of the tire. Never use solvents.

Check the tire beads and clean their surface with a dry cloth. Never use solvents.

Only use new tubes (if applicable for the tube type tire) and new air valves (for tubeless tires).

Do not use damaged or broken rims.

The flange must be clean and smooth to ensure uniform adherence. Do not mount rims with worn surfaces.

INSPECTION AND CLEANING



FIG_02



FIG_03



Mounting & dismounting

INSPECTION AND VALVE MOUNTING

Place the rim on the mounting device.
 Before mounting the tire on the rim, check that the inflation valve functions properly. (fig_04)
 It is recommended to always use new valves at every mounting. (Fig_05/06)



FIG_04



FIG_05

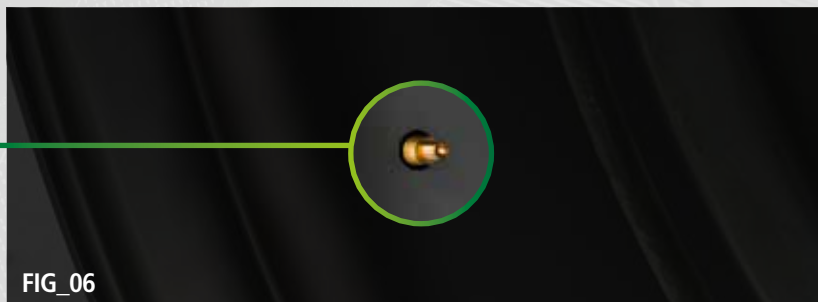

FIG_06

LUBRICATION OF TIRE RIM AND BEAD

Use a soft-bristled brush to spread the lubricant over the surface of the rim flange and bead seat, preferably when mounted on the tire changer. (Fig_07)
 Spread the lubricant over the surface of the Tire Bead. (Fig_08/09)
 Use specific lubricants for tire mounting only.
 Do not use silicone or other solvent-based substances.



FIG_07



FIG_08

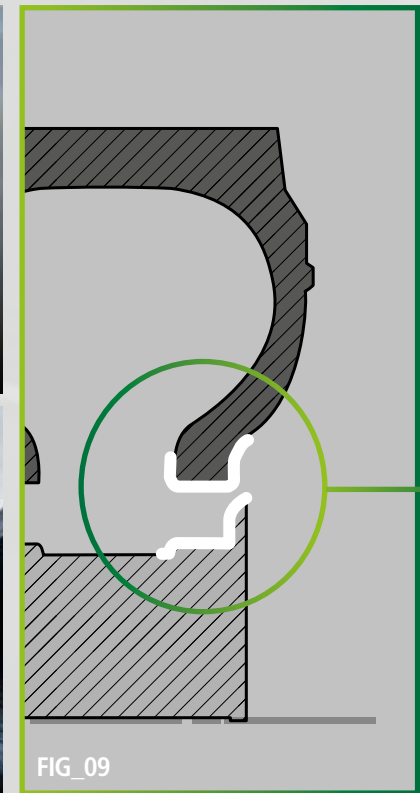

FIG_09



Mounting & dismounting

BEAD POSITIONING

Position the pliers in the direction of the valve, so as to ensure that the bead does not pass near the valve. (Fig_10)

Be careful to position the tire following the correct direction of rotation indicated on the sidewall.

Position the internal tire bead (or the first bead) on the pliers set on the rim corresponding to the valve.

Slide the first bead fully into the rim base, assisted by the rotation of the rim on the tire changer. (Fig_11)



FIG_10

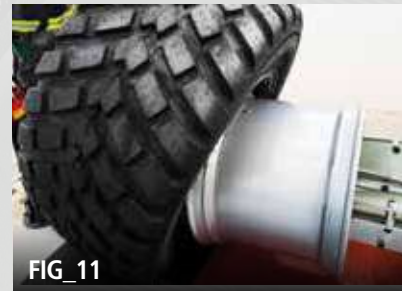

FIG_11



FIG_12

Move the tire so that part of the second bead is "unseated" in regard to the pliers set on the rim. (Fig_12)

Start up the machine and rotate the tire. (Fig_13)

Put the head of the tire changer between the second bead and the rim. This makes it possible to "unseat" the bead over the edge of the rim.

Bead the tire by rotating the rim and (if and when necessary) using a lever.

When the entire second bead has been released from the edge of the rim, extract the head of the tire changer.

Remove the pliers from the rim.

Make sure that the entire bead is correctly fitted within the rim. (Fig_14)

***In the case of agricultural tires, use the inner groove to facilitate the "unseating" of the bead on the edge of the rim.**

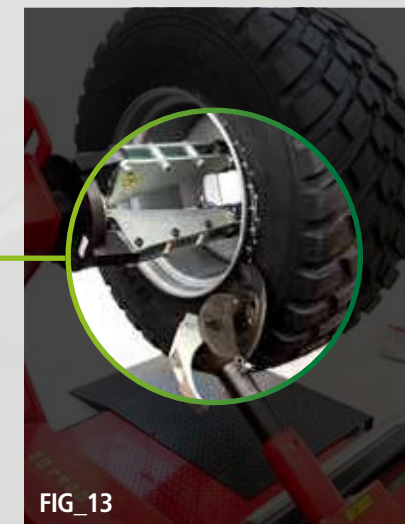

FIG_13



FIG_14



Mounting & dismounting

FINAL CHECK

ATTENTION!
 FOLLOW THE CORRECT SAFETY PROCEDURES! NEVER STAND NEXT TO THE SIDEWALLS/BEADS OF THE TIRE WHILE IT IS BEING INFLATED – IF POSSIBLE, USE SAFETY CAGES AND FOLLOW THE ENVISAGED INTERNAL SAFETY PROCEDURES.

Check that both tire beads are correctly positioned on the rim.

Inflate the tire on the rim up to the maximum pressure set out on the sidewall of the tire to seat properly the bead. (Fig_15)

Check that the two beads are correctly mounted on the rim.

Using a specific leak finder, also check that there are no leaks from the valve. (Fig_16)

Once the correct mounting of the tire has been ensured, adjust the tire pressure according to manufacturer recommendations and the intended operating conditions. (Fig_17)



FIG_15



FIG_16

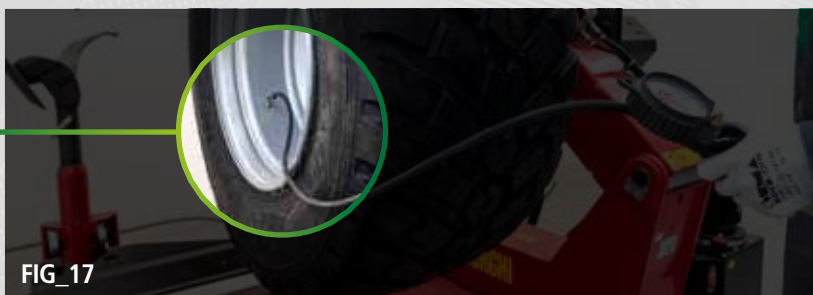

FIG_17

When filling the tire with liquid, it is recommended not to exceed 75% of its volume, in order to leave an air reserve of at least 25% of the tire volume. (Fig_18)

At any rate, it is important to inflate the tire at the pressure recommended by the manufacturer with reference to the loading conditions in order to maintain specific tire features such as elasticity.

In areas with a harsh climate, it is advised to add anti-freezing agents such as calcium chloride or magnesium chloride. It is highly recommended that these operations are carried out by a professional specialist only.

ADDITIONAL RECOMMENDATIONS

25% AIR

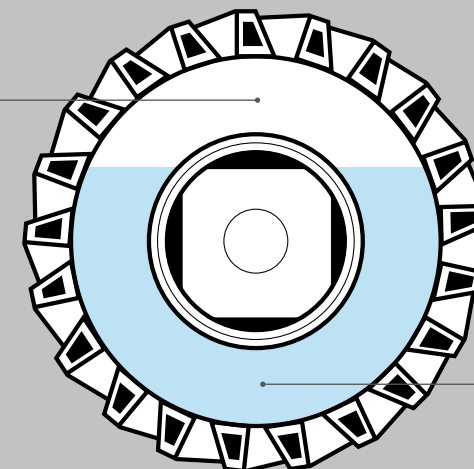

75% WATER

FIG_18



Tire transporation & storage



**ALWAYS
UPRIGHT**

TIRE STORAGE

This leaflet contains recommendations about tire storage for all types of tires, especially BKT Agricultural, Industrial and OTR tires – no matter how big or small your entity is. These recommendations apply to all tires you need to store, no matter how long the storage period and whether tires are fitted on rims or not. Potentially influencing external factors such as temperature, light, humidity, heat, ozone as well as chemical agents are taken into account.

DISCLAIMER OF LIABILITY:

BKT does not undertake any responsibility in relation to the exactness or correctness of information or illustrations contained in this section. BKT declines any direct or indirect liability for any materal damage or personal injury which might arise directly or incidentally from the use of any informaton contained in this section. For any question in relation to specific operating issues always refer to the manufacturer of your vehicle or equipment.



Tire transporation & storage

WEATHERING



Storage temperatures

The best storage temperature for your tires is below 25°C. Temperatures till 35°C are acceptable, but if tire storage temperatures exceed 50°C, deterioration processes affecting the tire service life are likely to occur. Proper stock rotation may reduce this phenomenon but will not exclude it completely. Avoid any direct contact with heat conditioning pipes or tubes, and radiators. Please, be aware that also low temperatures can cause stiffness, which does not necessarily have a permanently deteriorating effect, but will cause difficulties when mounting the tires. In case of handling tires at such temperatures, be careful and avoid possible distortions. When picking tires after storage at low temperatures, we recommend to carefully raise their temperature to approx. 20°C before you put them into service.

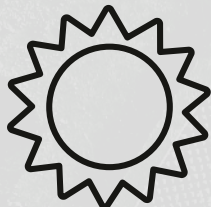

Light exposure

Protect your tires against any exposure to light. Please be aware that ultraviolet (UV) radiation of sunlight or artificial light sources deteriorate your tires.



Humidity and moisture

The best way to store tires is indoors in a dry, cool, and well-aerated area. Avoid any moist or humid conditions, and make sure that there is no condensate formation. Should you store your tires outdoors, instead, make sure to cover them appropriately in such a way that they are protected against precipitation or water on the ground, moisture and sunlight, or other external influences.

Be aware that ozone is a very powerful oxidant and extremely harmful. This is why you should not store your tires at places or rooms with ozone-generating devices as you can find in many applications. Avoid fluorescent lighting, especially fluorescent tubes that are commonly used as overhead fixture, and mercury vapor lamps that produce UV-light. Do not store your tires close to any electrical devices or machinery, which may produce sparks or any kind of electric discharges. Also avoid combustion gases or vapors, which may produce ozone by means of photo-chemical processes.

Make sure that you do not keep fuels, acids, solvents, lubricants, disinfectants or any other chemical substance or composition in tire storage rooms or areas. Also rubber solutions are to be stored in separate rooms. In any case, observe all administrative regulations on the use, handling, and storage of inflammable liquids.

OZONE AND OTHER CHEMICAL AGENTS





Tire transportation & storage

WAREHOUSE

Deformation

If you keep tires in stock, make sure that products are stored in a relaxed state. This means that they are not compressed, and free from tension or any other forces that might have a distorting effect.

Stock rotation

It is important that the storage period of new tires is kept as short as possible. We recommend carrying out stock rotation by implementing the First-in, First-out (FIFO) method.



ALWAYS UPRIGHT

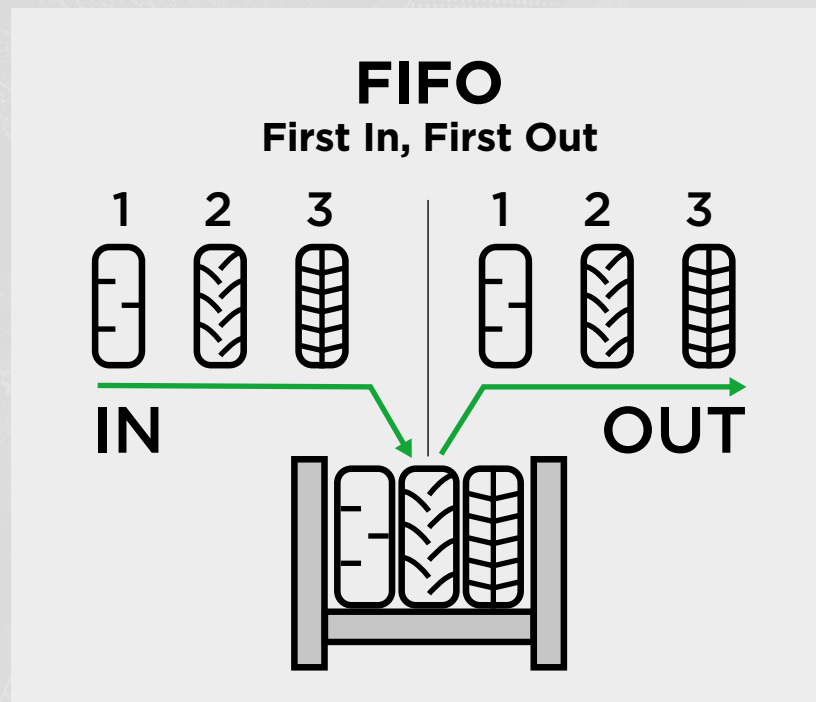

The best way to store your tires is in an upright position. This can be in single layers on a tire rack or shelf. Interlaced storage (fishbone method) is also possible, but avoid stacking your tires horizontally (stovepipe method), one on top of the other. Should this be impossible, limit the interlacing or stacking height to avoid that your tires are permanently deformed, especially at the bottom of the stacks, in addition to possible stability issues.

For tires that are fitted on rims, the best way to store them is in an inflated state and in an upright position, or in a single layer on a tire rack or shelf.

CORRECT TIRE STORAGE



ALWAYS UPRIGHT





Tire transportation & storage

TRANSPORT

Tire transportation

BKT tires are designed for the most differing applications in agriculture, OTR and manifold industrial sectors. Many Off-Highway tires are very heavy and difficult to be transported. Wrong transportation of a tire can cause serious damage.

When transporting a tire, make sure that neither the bead nor the inner part of the tire is damaged. Even the slightest damage of the bead can cause permanent damage due to air leakage resulting in tire underinflation and possible separation of the tire components.

In order to minimize the risk of damages or issues due to wrong tire transportation or handling, it is highly advised to observe the following recommendations:



YES

- Use a forklift for transport.
- The tire is to be lifted from the thread and not from the bead.
- Use large fibered straps, rubber slings or specific belts.





Tire transporation & storage

NO

- Do not lift the tire by using a crane hook making leverage on the bead.
- Do not use ropes, steel slings or chains.



Transport conditions

All recommendations made before in relation to tire storage methods and conditions also apply to their transport. If closed containers without air-conditioning are used for tire transport, limit the length of the storage period as much as possible to avoid any risk of tire deterioration or degradation. Should you observe any sign of visual tire deformation, wait the time necessary to recover its original shape when inflating the tire.

TRANSPORT





Tire transporation & storage

TUBES

In addition to the above notice, we recommend to store tire tubes according to one of the following methods: You can place slightly inflated tubes dusted with talcum in the tires for storage. Otherwise, you can store deflated tubes in small stacks not exceeding a height of max. 50 cm on an even and flat, dry and clean surface. Do not store tubes on slatted palettes because of the possible pressure applied at some point.

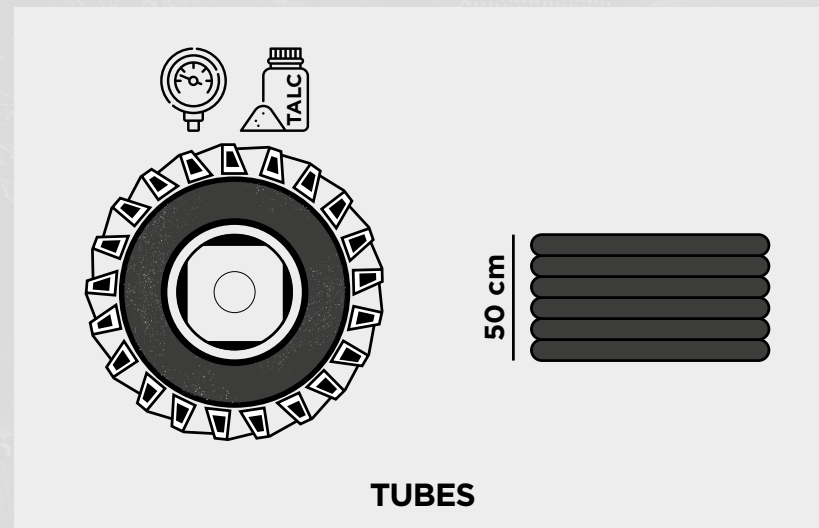

IMPORTANT NOTICE

All tire storage recommendations on the previous pages regarding light exposure, storage temperature, ozone and other chemical agents also apply to tubes, flaps, o-ring seals, and other wheel components.

FLAPS AND O-RING SEALS

Flaps

In addition to the above notice, we recommend to store tire flaps according to one of the following methods: The best way to store flaps is placing them along with the tubes inside the tire. Otherwise, they can be stored separately by laying them flat on shelves that are free from moisture, dust, and grease. Do never store them by hanging or in a suspended position to avoid the risk of elongation and deformation.

O-ring seals

Store o-ring seals for tires in a flat position at a dry and cool place. Never stack other component or materials on tire o-rings.





Tire transporation & storage

VALVES



As for all other tire components, there are some particular storage recommendations for valves. Always protect valves from exposure to direct sunlight and contamination of oils, lubricants, fuels, solvents or other chemical substances.

Best storage temperatures for tire valves are at 15-25°C. Avoid higher temperatures. Also be aware that lower temperatures can cause material stress. In case of storage temperatures below 15°C, let the valve temperature raise to 15-20°C before fitting to avoid any valve damage.

Be aware that the rubber components of the valve, even if correctly stored, change their physical properties during the natural ageing process. In particular, hardness increases along with losing elasticity. We therefore recommend the shortest possible storage time as well as First-in, First-out (FIFO) stock management.

We recommend to store valves for short periods only (max. 1 year).

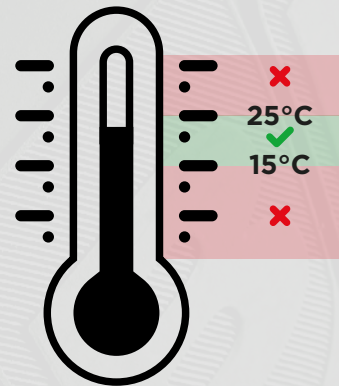

ORIGINAL PACKAGING

Tire tubes, flaps, o-ring seals, valves and other components are usually delivered by the manufacturer wrapped in film and/or in cardboard boxes. If so, store them in the original packaging that provides a minimum protection against some external effects such as light, ozone and contamination.

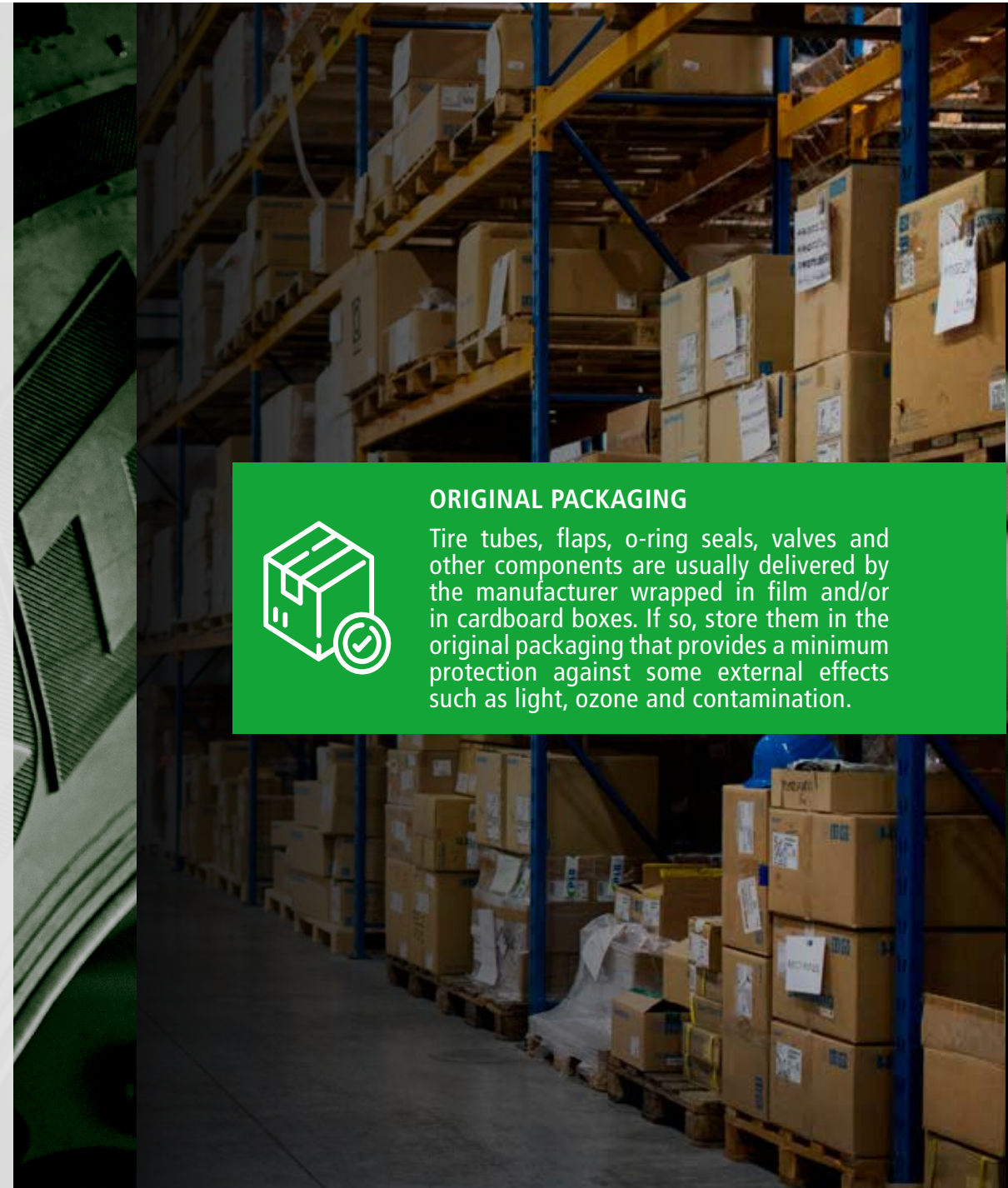



Sustainability

What are end-of-life tires (ELTs)?

ELTs are tires that have reached the end of their product life-cycle. They are worn-out, cracked or bursted tires, which cannot be retreaded and are no longer suitable for their intended purpose. ELT management is an issue of major concern in line with our focus on sustainability. Recovering ELTs leads to reduced waste. Moreover, it is a valuable resource for fuel or other material. As conscientious tire manufacturer, we wish to provide you with some guidelines about handling, storing, recycling, and recovering ELTs.

How to handle and store ELTs?

Store end-of-life tires in a place that is sheltered against rain, since the accumulation of rainwater would favor the breeding of mosquitoes inside the tire.

Likewise, end-of-life tires should not be stored on wetlands, flood plains, in ravines, or on any other steeply graded surface.

Open-air or uncontrolled burning in any place is harmful to the environment and is therefore forbidden by many legislations.

Lightening rods should be placed at a safe distance from tire piles.

Precautions must be taken against deliberate or accidental igniting of tire stock piles in the storage area.

Install an adequate number of fire-fighting devices. In addition, sand and dirt can be used to cover burning tires; whereas water can be used to wet unburned tires preventing ignition.

It is recommended to maintain an adequate buffer zone in the storage area in order to isolate any deliberate or accidental fire.

Provide for an emergency vehicle access road in each tire storage yard and between tire piles.

A tire is composed of several materials depending on the specific tire type; these include

46-48% rubber

25-28% carbon black

10-12% steel

10-12% oil and vulcanizing agents

3-6% synthetic yarns and textiles

End-of-life tire composition

TIRE LIFE-CYCLE

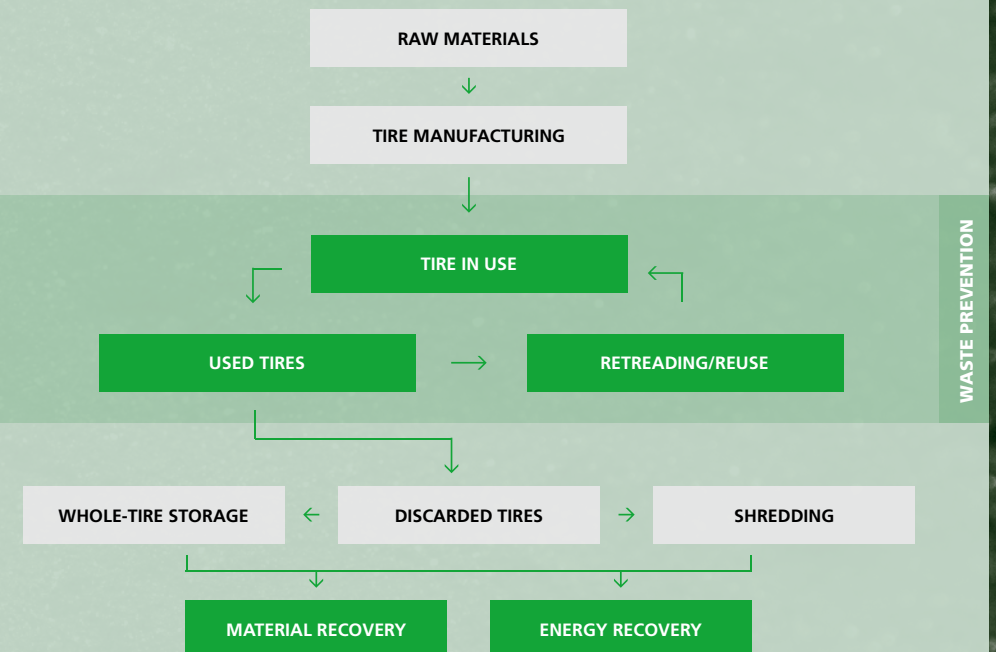

ELT recovery and recycling

When a tire reaches the ELT stage, a proper waste management system is to be applied. It is important that recovery and/or final disposal take place in an environmentally sound manner. ELTs can be destroyed ecologically using the materials obtained for other purposes.

Basically, an ELT can be divided into three product classes:

RUBBER GRANULES

STEEL INSERTS

SYNTHETIC YARN INSERTS AND TEXTILES



Recycling by transforming waste tires into rubber powder

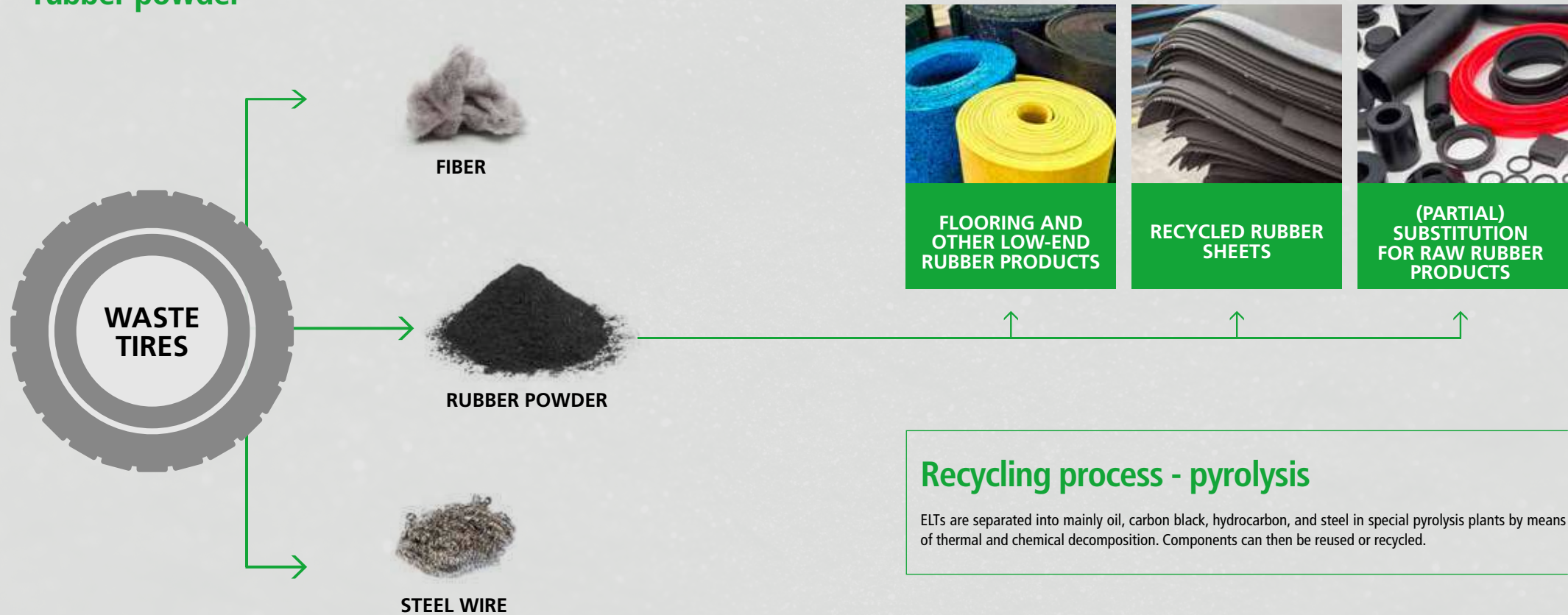

Recycling process - pyrolysis

ELTs are separated into mainly oil, carbon black, hydrocarbon, and steel in special pyrolysis plants by means of thermal and chemical decomposition. Components can then be reused or recycled.

For what purposes can end-of-life tires be used?

ELTs can be a low-cost source of fuel when located near a major fuel consumer, such as a power plant or cement factory. They can also be readily processed for a diverse range of construction projects.

ENERGY RECOVERY

- Alternative fuel/oil is mainly used in cement kilns and also in thermal power stations, pulp and paper mills.
- Derived Fuel (TDF) is a source of low-cost fuel for power generation or can be used as heat source for boiler co-generation.

MATERIAL RECOVERY

- Rubber can be reused in the tire industry as crumb.
- Rubber can also be used for low-end rubber products, flooring etc.
- Shredded fabric can be recycled for solid tires.
- ELTs can be processed for several types of construction projects.
- Bead wires (steel wire) can be smelted to obtain recycled steel.



Notes

A series of horizontal dotted lines for taking notes, starting from a solid vertical line on the left.



GROWING TOGETHER

Corporate Office

Balkrishna Industries Ltd.

BKT HOUSE, C/15, Trade World, Kamala Mills Compound, Senapati Bapat Marg, Lower Parel, Mumbai - 400013, India
Tel: (+91) 22-6666 3800 - Fax: (+91) 22-6666 3898/99 - e-mail: info@bkt-tires.com - bkt-tires.com

BKT Europe srl

Viale Della Repubblica, 133
20831 Seregno (MB), Italy
Tel: (+39) 0362 33 03 28
(+39) 0362 32 51 07
Fax: (+39) 0362 23 24 72

BKT USA Inc.

202 Montrose West Ave. Suite 240
Copley, Ohio 44321
Tel: (+1) 330 836 1090
Fax: (+1) 330 836 1091
Toll Free: (+1) 888 660 0662

BKT Tires (CANADA) Inc.

55 York Street, Suite 401
Toronto, Ontario M5J 1R7, Canada
Tel: AG/IND (+1) 514 792 9220
OTR (+1) 780 888 5667
Fax: (+1) 416 229 1711



bkt-tires.com